



Owner's Manual

Original Instructions

Split Type Floor-standing Air Conditioner



Thank you for choosing our product.

Please read this Owner's Manual carefully before operation and retain it for future reference.

If you have lost the Owner's Manual, please contact the local agent or visit www.gree.com or send an email to global@cn.gree.com for the electronic version.

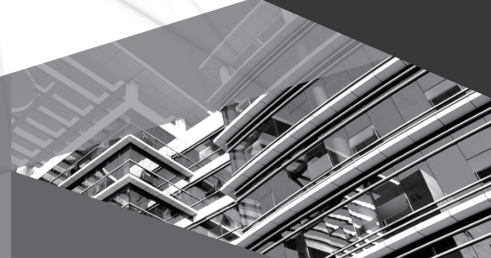

GVH48AL-M6DNC7A

Content

Operation Notices

The Refrigerant	1
Precautions	2
Parts Name	7

Operation Guide

Button's Name and Function	8
Introduction for icons on display screen of air conditioner	8
Button's introduction	9
Buttons on remote controller	11
Introduction for icons on display screen	11
Introduction for buttons on remote controller	12
Function introduction for combination buttons	16
Replacement of batteries in remote controller	17

Maintenance

Clean and maintenance	18
-----------------------------	----

Malfunction

Malfunction	20
Safety operation of flammable refrigerant	24

Installation Notice

Installation dimension diagram	26
Safety precautions for installing and relocating the unit	27
Tools for installation	28
Selection of installation location	28
Requirements for electric connection	29

Installation

Installation of indoor unit	30
Installation of outdoor unit	34
Vacuum pumping	37
Leakage detection	37
Check after installation	38
Test operation	38

Attachment

Installation instructions of anti-collapse chain	39
Configuration of connection pipe	40
Pipe expanding method	42
Specialist's Manual	43

This appliance is not intended for use by persons (including children) with reduced physical, sensory or mental capabilities, or lack of experience and knowledge, unless they have been given supervision or instruction concerning use of the appliance by a person responsible for their safety. Children should be supervised to ensure that they do not play with the appliance.

- 1) Frequency band(s) in which the radio equipment operates: 2400MHz-2483.5MHz
- 2) Maximum radio-frequency power transmitted in the frequency band(s) in which the radio equipment operates: 20dBm



This marking indicates that this product should not be disposed with other household wastes throughout the EU. To prevent possible harm to the environment or human health from uncontrolled waste disposal, recycle it responsibly to promote the sustainable reuse of material resources. To return your used device, please use the return and collection systems or contact the retailer where the product was purchased. They can take this product for environmental safe recycling.

R32: 675

Explanation of Symbols



DANGER

Indicates a hazardous situation that, if not avoided, will result in death or serious injury.



WARNING

Indicates a hazardous situation that, if not avoided, could result in death or serious injury.



CAUTION

Indicates a hazardous situation that, if not avoided, may result in minor or moderate injury.

NOTICE

Indicates important but not hazard-related information, used to indicate risk of property damage.



Indicates a hazard that would be assigned a signal word **WARNING** or **CAUTION**.

Exception Clauses

Manufacturer will bear no responsibilities when personal injury or property loss is caused by the following reasons.

1. Damage the product due to improper use or misuse of the product;
2. Alter, change, maintain or use the product with other equipment without abiding by the instruction manual of manufacturer;
3. After verification, the defect of product is directly caused by corrosive gas;
4. After verification, the defects are due to improper operation during transportation of product;
5. Operate, repair, maintain the unit without abiding by instruction manual or related regulations;
6. After verification, the problem or dispute is caused by the quality specification or performance of parts and components that produced by other manufacturers;
7. The damage is caused by natural calamities, bad using environment or force majeure.

If it needs to install, move or maintain the air conditioner, please contact dealer or local service center to conduct it at first. Air conditioner must be installed, moved or maintained by appointed unit. Otherwise, it may cause serious damage or personal injury or death.

When refrigerant leaks or requires discharge during installation, maintenance, or disassembly, it should be handled by certified professionals or otherwise in compliance with local laws and regulations.



Appliance filled with flammable gas R32.



Before use the appliance, read the owner's manual first.



Before install the appliance, read the installation manual first.



Before repair the appliance, read the service manual first.

The Refrigerant

- To realize the function of the air conditioner unit, a special refrigerant circulates in the system. The used refrigerant is the fluoride R32, which is specially cleaned. The refrigerant is flammable and inodorous. Furthermore, it can lead to explosion under certain conditions. But the flammability of the refrigerant is very low. It can be ignited only by fire.
- Compared to common refrigerants, R32 is a nonpolluting refrigerant with no harm to the ozonosphere. The influence upon the greenhouse effect is also lower. R32 has got very good thermodynamic features which lead to a really high energy efficiency. The units therefore need a less filling.

WARNING:

Do not use means to accelerate the defrosting process or to clean, other than those recommended by the manufacture. Should repair be necessary, contact your nearest authorized Service Centre. Any repairs carried out by unqualified personnel may be dangerous. The appliance shall be stored in a room without continuously operating ignition sources. (for example: open flames, an operating gas appliance or an operating electric heater.) Do not pierce or burn.

Appliance shall be installed, operated and stored in a room with a floor area larger than $X \text{ m}^2$. (Please refer to table "a" in section of " Safety operation of flammable refrigerant " for Space X.)

Appliance filled with flammable gas R32. For repairs, strictly follow manufacturer's instructions only. Be aware that refrigerants may not contain an odour. Read specialist's manual.





WARNING

Operation and Maintenance

- This appliance can be used by children aged from 8 years and above and persons with reduced physical, sensory or mental capabilities or lack of experience and knowledge if they have been given supervision or instruction concerning use of the appliance in a safe way and understand the hazards involved.
- Children shall not play with the appliance.
- Cleaning and user maintenance shall not be made by children without supervision.
- Do not connect air conditioner to multi-purpose socket. Otherwise, it may cause fire hazard.
- Do disconnect power supply when cleaning air conditioner. Otherwise, it may cause electric shock.
- If the supply cord is damaged, it must be replaced by the manufacturer, its service agent or similarly qualified persons in order to avoid a hazard.
- Do not wash the air conditioner with water to avoid electric shock.
- Do not spray water on indoor unit. It may cause electric shock or malfunction.
- After removing the filter, do not touch fins to avoid injury.
- Do not use fire or hair dryer to dry the filter to avoid deformation or fire hazard.

Precautions



WARNING

- Maintenance must be performed by qualified professionals. Otherwise, it may cause personal injury or damage.
- Do not repair air conditioner by yourself. It may cause electric shock or damage. Please contact dealer when you need to repair air conditioner.
- Do not extend fingers or objects into air inlet or air outlet. It may cause personal injury or damage.
- Do not block air outlet or air inlet. It may cause malfunction.
- Do not spill water on the remote controller, otherwise the remote controller may be broken.
- When below phenomenon occurs, please turn off air conditioner and disconnect power immediately, and then contact the dealer or qualified professionals for service.
 - Power cord is overheating or damaged.
 - There's abnormal sound during operation.
 - Circuit break trips off frequently.
 - Air conditioner gives off burning smell.
 - Indoor unit is leaking.
- If the air conditioner operates under abnormal conditions, it may cause malfunction, electric shock or fire hazard.
- When turning on or turning off the unit by emergency operation switch, please press this switch with an insulating object other than metal.
- Do not step on top panel of outdoor unit, or put heavy objects. It may cause damage or personal injury.



WARNING

Attachment

- Installation must be performed by qualified professionals. Otherwise, it may cause personal injury or damage.
- Must follow the electric safety regulations when installing the unit.
- According to the local safety regulations, use qualified power supply circuit and circuit break.
- Do install the circuit break. If not, it may cause malfunction.
- An all-pole disconnection switch having a contact separation of at least 3mm in all poles should be connected in fixed wiring.
- Including an circuit break with suitable capacity, please note the following table. Air switch should be included magnet buckle and heating buckle function, it can protect the circuit-short and overload.
- Air Conditioner should be properly grounded. Incorrect grounding may cause electric shock.
- Don't use unqualified power cord.
- Make sure the power supply matches with the requirement of air conditioner. Unstable power supply or incorrect wiring may result in electric shock, fire hazard or malfunction. Please install proper power supply cables before using the air conditioner.
- Properly connect the live wire, neutral wire and grounding wire of power socket.
- Be sure to cut off the power supply before proceeding any work related to electricity and safety.

Precautions



WARNING

- Do not put through the power before finishing installation.
- If the supply cord is damaged, it must be replaced by the manufacturer, its service agent or similarly qualified persons in order to avoid a hazard.
- The temperature of refrigerant circuit will be high, please keep the interconnection cable away from the copper tube.
- The appliance shall be installed in accordance with national wiring regulations.
- Installation must be performed in accordance with the requirement of NEC and CEC by authorized personnel only.
- The air conditioner is the first class electric appliance. It must be properly grounding with specialized grounding device by a professional. Please make sure it is always grounded effectively, otherwise it may cause electric shock.
- The yellow-green wire in air conditioner is grounding wire, which can't be used for other purposes.
- The grounding resistance should comply with national electric safety regulations.
- The appliance must be positioned so that the plug is accessible.
- All wires of indoor unit and outdoor unit should be connected by a professional.
- If the length of power connection wire is insufficient, please contact the supplier for a new one. Avoid extending the wire by yourself.

Precautions



WARNING

- For the air conditioner with plug, the plug should be reachable after finishing installation.
- For the air conditioner without plug, an circuit break must be installed in the line.
- If you need to relocate the air conditioner to another place, only the qualified person can perform the work. Otherwise, it may cause personal injury or damage.
- Select a location which is out of reach for children and far away from animals or plants. If it is unavoidable, please add the fence for safety purpose.
- The indoor unit should be installed close to the wall.
- Instructions for installation and use of this product are provided by the manufacturer.

Working temperature range

	Indoor side DB/WB(°C)	Outdoor side DB/WB(°C)
Maximum cooling	32/23	43/26
Maximum heating	27/-	24/18

NOTICE:

- The operating temperature range (outdoor temperature) for cooling only unit is -15°C ~ 43°C ; for heat pump unit is -15°C ~ 43°C.

Parts Name

Indoor Unit

display and button

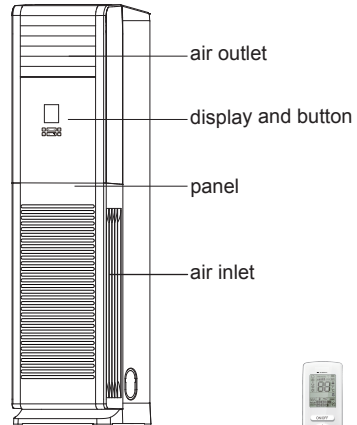
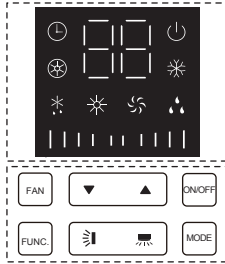

remote controller

(Display content or position may be different from above graphics, please refer to actual products)

Outdoor Unit

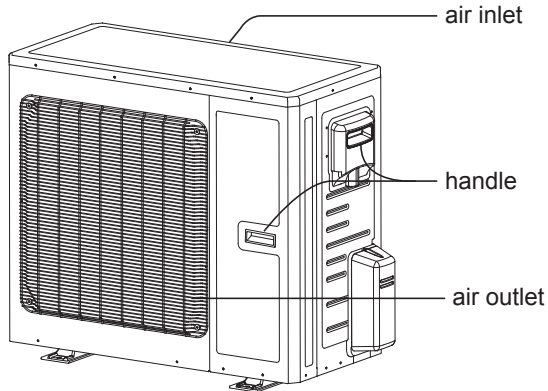

NOTICE:

Actual product may be different from above graphics, please refer to actual products.

Button's Name and Function

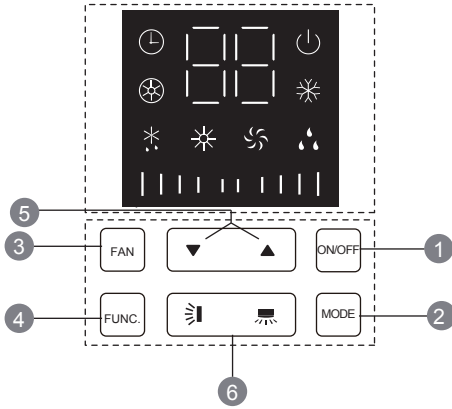

- 1 ON/OFF button
- 2 MODE button
- 3 FAN button
- 4 FUNCTION button
- 5 ▼/▲ button
- 6 ☀/☁ button

Introduction for icons on display screen of air conditioner

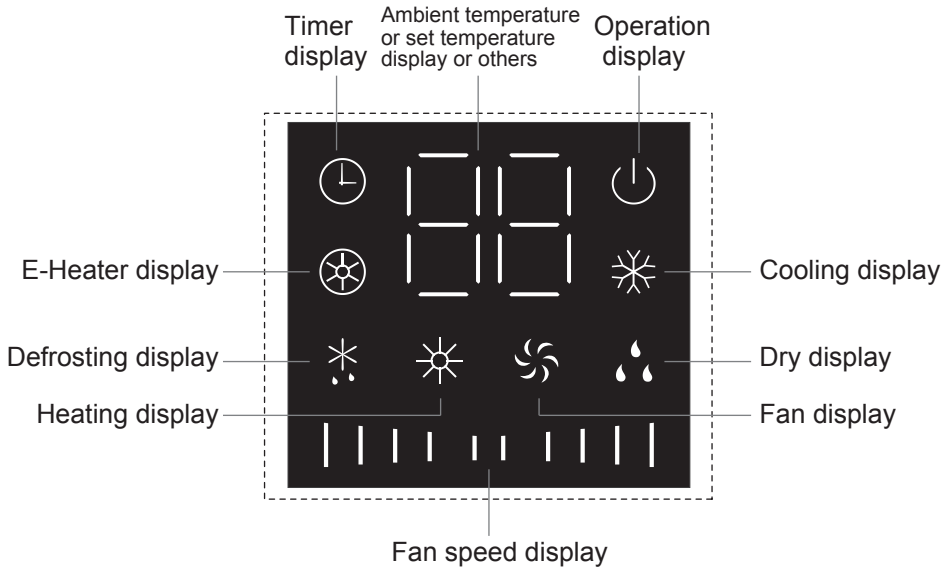

Button's introduction

Note:

This series unit adopts touch buttons. You only need to touch the buttons slightly.

1 ON/OFF button

- Press this button to turn on or turn off the unit.(Note: Under X-FAN mode, press this button to turn on the unit directly.)

2 MODE button

- Every time press this button, the mode will switchover in cycle among.

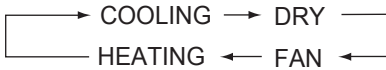

(Note: Cooling only unit won't accept heating operation signal. For cooling only unit, pressing MODE button under FAN mode will skip heating mode and enter cooling mode.)

3 FAN button

- Press this button and then fan speed can be selected and displayed in the sequence as below:

| | | (low) → | | | | (medium) → | | | | | | (high) →
| | | | | | | (turbo)

(Note:Only low fan speed is available for dry mode. Fan speed can't be adjusted under dry mode. Turbo cannot be set in FAN mode.)

4 FUNCTION button

- Under on status, press Function button to switch between timer and auxiliary heating function setting (auxiliary heating can be set only in heating mode). When timer or auxiliary heating icon is blinking, it means this function can be set. Press "▲" or "▼" button to set function. If there's no operation change within 5s after setting is finished, the function setting will be confirmed. Or press Function button again to exit or confirm the function.When the function is selected through Function button, if the unit is not turned off and no remote control signal is received within 2min, pressing Function button again to circulate from the previous set function. After 2min or the unit is turned off or remote control signal is received, pressing Function button again to circulate from timer icon. (Note: Only when the unit is under heating mode and with auxiliary heating function, auxiliary heating function can be turned on or off through Function button.)
- Under off status, if the unit is in X-FAN status, press Function button to turn off the unit directly; if the unit is not in X-FAN status, press Function button to set timer ON.

Button's introduction

5 ▼/▲ button

- After each pressing of "▲" or "▼" button, set temperature will increase or decrease 1°C. Temperature adjustment range is 16°C~30°C. This button is invalid under auto mode. Timer setting can be set in 1h increment among 0~24h. When it is adjusted to auxiliary heating function setting through Function button, press this button to turn on or turn off auxiliary heating. (Note: auxiliary heating is valid only for the model with this function.)
- Hold "▲" and "▼" buttons for 3s and the air conditioner will display "LC", which indicates buttons are locked. Any button under on status or ON/OFF button and function buttons under off status are all invalid. Hold these two button for 3s again to release the lock.

6 / button

- Left and right swing: this button controls the left and right swing motor, single press it to switchover between ON and OFF.
- Up and down swing: this button controls the up and down swing motor, single press it to switchover between ON and OFF.

Icon function introduction

Operation display

- It indicates the air conditioner is put through the power. Under on status, this indicator is on; under off status, this indicator is off.

Timer display

- When this indicator is on, it indicates the timer function is turned on.

Heating display

- When this indicator is on, it indicates the heating mode is turned on.

Defrosting display

- When this indicator is on, it indicates the defrosting function is turned on.

Dry display

- When this indicator is on, it indicates the dry mode is turned on.

E-Heater display

- When this indicator is on, it indicates the E-heater function is turned on.
- This function is only available for some models.

Cooling display

- When this indicator is on, it indicates the cooling mode is turned on.

Fan display

- When this indicator is on, it indicates the fan mode is turned on.

Fan speed display

- Displays the fan speed. The fan speed is displayed as below:

| | | | | (low) → | | | | | (medium) → | | | | | | | | | (high) → | | | | | | | | | (turbo)

Buttons on remote controller

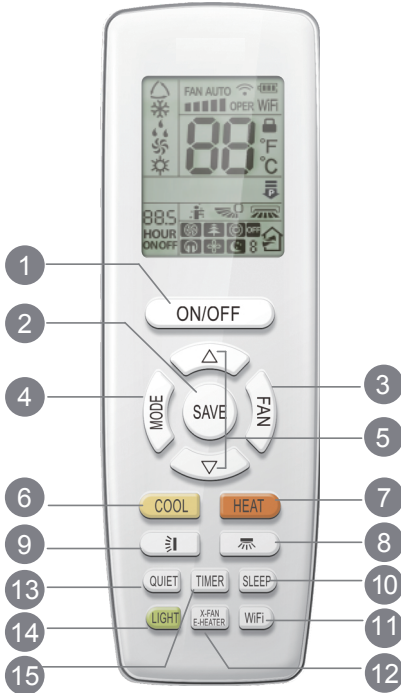

- 1 ON/OFF button
- 2 SAVE button
- 3 FAN button
- 4 MODE button
- 5 ▲/ ▼ button
- 6 COOL button
- 7 HEAT button
- 8 button
- 9 button
- 10 SLEEP button
- 11 WiFi button
- 12 X-FAN/E-HEATER button
- 13 QUIET button
- 14 LIGHT button
- 15 TIMER button

Introduction for icons on display screen

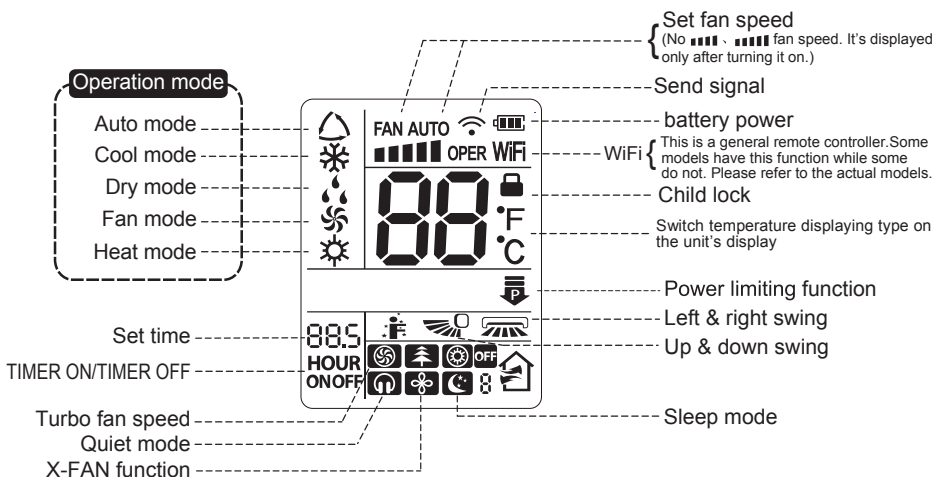

Introduction for buttons on remote controller

Note:

- This is a general use remote controller, it could be used for the air conditioners with multifunction; For some function, which the model doesn't have, if press the corresponding button on the remote controller that the unit will keep the original running status.
- After putting through the power, the air conditioner will give out a sound. Operation indicator "⏻" is ON. After that, you can operate the air conditioner by using remote controller.
- Under on status, pressing the button on the remote controller, the signal icon "📶" on the display of remote controller will blink once and the air conditioner will give out a "di" sound, which means the signal has been sent to the air conditioner.

1 ON/OFF button

Press this button can turn on or turn off the air conditioner. After turning on the air conditioner, indoor unit will give out a sound.

2 SAVE button

Under cooling mode, press this button to start up or turn off energy-saving function. When energy-saving function is started up, "SE" will be shown on remote controller, and air conditioner will adjust the set temperature automatically according to ex-factory setting to reach to the best energy-saving effect. Press this button again to exit energy-saving function.

3 FAN button

Pressing this button can set fan speed circularly as: auto (AUTO), low(■), medium (■■), high(■■■), turbo(🌀).



Note:

- Under AUTO speed, air conditioner will select proper fan speed automatically according to ex-factory setting.
- It's Low fan speed under Dry mode.
- Turbo cannot be set in FAN mode.

Introduction for buttons on remote controller

4 MODE button

Press this button to select your required operation mode.

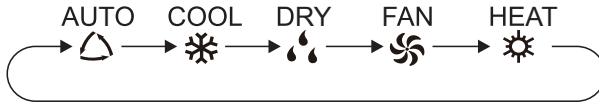

- When selecting auto mode, air conditioner will operate automatically according to the sensed temperature. Set temperature can't be adjusted and will not be displayed as well. Press "FAN" button can adjust fan speed. Press "☀️" / "🌀" button can adjust fan blowing angle.
- After selecting cool mode, air conditioner will operate under cool mode. Cool indicator "❄️" on indoor unit is ON(This indicator is not available for some models). Press "▲" or "▼" button to adjust set temperature. Press "FAN" button to adjust fan speed. Press "☀️" / "🌀" button to adjust fan blowing angle.
- When selecting dry mode, the air conditioner operates at low speed under dry mode. Dry indicator "💧" on indoor unit is ON(This indicator is not available for some models). Under dry mode, fan speed can't be adjusted. Press "☀️" / "🌀" button to adjust fan blowing angle.
- When selecting fan mode, the air conditioner will only blow fan, no cooling and no heating. Fan indicator "🌀" on indoor unit is ON. Press "FAN" button to adjust fan speed. Press "☀️" / "🌀" button to adjust fan blowing angle.
- When selecting heating mode, the air conditioner operates under heat mode. Heat indicator "☀️" on indoor unit is ON(This indicator is not available for some models). Press "▲" or "▼" button to adjust set temperature. Press "FAN" button to adjust fan speed. Press "☀️" / "🌀" button to adjust fan blowing angle. (Cooling only unit won't receive heating mode signal. If setting heat mode with remote controller, press ON/OFF button can't start up the unit).

Note:

- For preventing cold air, after starting up heating mode, indoor unit will delay 1~5 minutes to blow air (actual delay time is depend on indoor ambient temperature).
- Set temperature range from remote controller: 16~30°C (61~86°F);
Fan speed: auto, low speed, medium speed, high speed, turbo speed.

5 ▲ / ▼ button

- Press "▲" or "▼" button once increase or decrease set temperature 1°C (°F). Holding "▲" or "▼" button, 2s later, set temperature on remote controller will change quickly. On releasing button after setting is finished, temperature indicator on indoor unit will change accordingly. (Temperature can't be adjusted under auto mode)
- When setting TIMER ON, TIMER OFF, press "▲" or "▼" button to adjust time. (Refer to TIMER button for details)

Introduction for buttons on remote controller





6 Cool button

- Press this button, unit will operate in cool mode.

7 Heat button



- Press this button, unit will operate in heat mode.

8 button



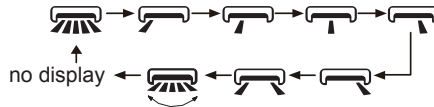

- Under simple swing mode, press this button can turn on ("" icon is displayed) or turn off ("" icon is not displayed) the left&right swing function.
- When the unit is turned off by remote controller, press "▲" button and "" button can switch between single swing mode and fixed-angle swing mode. "" on the remote controller will flash twice.

Under fixed-angle swing mode, press this button and then left&right swing status will circulate as shown in the right figure:



- This remote controller is the general type remote controller. When remote controller receives the signal of "", swing status is same as ""; when remote controller receives "", swing status is same as left&right swing OFF.

9 button

- Under simple swing mode, press this button can turn on ("" icon is displayed) or turn off ("" icon is not displayed) the up&down swing function.
- When the unit is turned off by remote controller, press "▲" button and "" button can switch between single swing mode and fixed-angle swing mode. "" on the remote controller will flash twice.

Under fixed-angle swing mode, press this button and the up&down swing status will circulate as shown in the right figure:

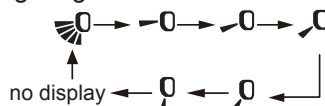

Introduction for buttons on remote controller

10 SLEEP button

Under COOL or HEAT mode, press this button to start up sleep function.

"☾" icon is displayed on remote controller. Press this button again to cancel sleep function and "☾" icon will disappear. After powered on, Sleep Off is defaulted. After the unit is turned off, the Sleep function is canceled.

In this mode, set temperature will be adjusted with the change of time. Under Fan, DRY and Auto modes, this function is not available.

11 WiFi button

Press "WiFi" button to turn on WiFi function, "WiFi" icon will be displayed on the remote controller;

Hold "WiFi" button for 5s to turn off WiFi function and "WiFi" icon will disappear. Under off status, press "MODE" and "WiFi" buttons simultaneously for 1s, WiFi module will restore factory settings.

- This function is only available for some models.

12 X-FAN/E-HEATER button

Pressing this button in COOL or DRY mode, the icon "⊗" is displayed and the indoor fan will continue operation for a few minutes in order to dry the indoor unit even though you have turned off the unit. After energization, X-FAN OFF is defaulted. X-FAN is not available in AUTO, FAN or HEAT mode.

This function indicates that moisture on evaporator of indoor unit will be blown after the unit is stopped to avoid mould.

- Having set X-FAN function on: After turning off the unit by pressing ON/OFF button indoor fan will continue running for about a few minutes. at low speed. In this period, press X-FAN button to stop indoor fan directly.
- Having set X-FAN function off: After turning off the unit by pressing ON/OFF button, the complete unit will be off directly.
- Only under cooling mode and dry mode, press this button can turn on (characters of "X-FAN" are displayed) or turn off (characters of "X-FAN" are not displayed) X-FAN function.
- Under heating mode, press this button and the E-HEATER status will changed circularly as below (This function is only available for some models):

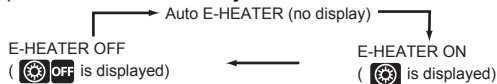

13 QUIET button

Press this button can turn on or turn off QUIET function.

- This function is not available for this unit.

14 LIGHT button

Press this button to turn off display light on indoor unit. Press this button again to turn on display light.

Introduction for buttons on remote controller

15 TIMER button

- At ON status, press this button once can set TIMER OFF. The character of HOUR and OFF will flash. Press "▲" or "▼" button within 5s can adjust the time of TIMER ON. After each pressing of "▲" or "▼" button, time will increase or decrease half an hour. When holding "▲" or "▼" button, 2s later, the time will change quickly until to reach to your required time. After that, press "TIMER" button to confirm it. The character of HOUR and OFF won't flash again.
Cancel TIMER OFF: Press "TIMER" button again under TIMER OFF status.
- At OFF status, press this button once can set TIMER ON. Please refer to TIMER off for detailed operation.
Cancel TIMER ON: Press "TIMER" button again under TIMER ON status.

Note:

- Time setting range: 0.5-24 hours.
- Time interval between two operations can't exceed 5s. Otherwise, remote controller will exit the setting status automatically.

Function introduction for combination buttons

Child lock function

Press "▲" and "▼" simultaneously to turn on or turn off child lock function. When child lock function is on, "🔒" icon is displayed on remote controller. If you operate the remote controller, the "🔒" icon will blink three times without sending signal to the unit.

Temperature display switchover function

Under OFF status, press "▼" and "MODE" buttons simultaneously to switch temperature display between °C and °F .

Replacement of batteries in remote controller

1. Lift the cover along the direction of arrow (as shown in Fig 1 ①).
2. Take out the original batteries (as shown in Fig 1 ②).
3. Place two 7# (AAA 1.5V) dry batteries, and make sure the position of “+” polar and “-” polar is correct (as shown in Fig 2 ③).
4. Reinstall the cover (as shown in Fig 2 ④).

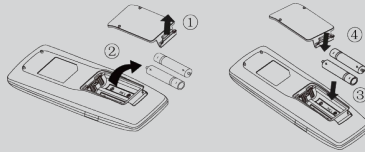

Fig.1

Fig.2

NOTICE

- During operation, point the remote control signal sender at the receiving window on indoor unit.
- The distance between signal sender and receiving window should be no more than 8m, and there should be no obstacles between them.
- Signal may be interfered easily in the room where there is fluorescent lamp or wireless telephone; remote controller should be close to indoor unit during operation.
- Replace new batteries of the same model when replacement is required.
- When you don't use remote controller for a long time, please take out the batteries.
- If the display on remote controller is fuzzy or there's no display, please replace batteries.

Clean and maintenance



WARNING

- Turn off the air conditioner and disconnect the power before cleaning the air conditioner to avoid electric shock.
- Do not wash the air conditioner with water to avoid electric shock.
- Do not use volatile liquid to clean the air conditioner.
- Do not use liquid or corrosive detergent clean the appliance and do not splash water or other liquid onto it, otherwise, it may damage the plastic components, even cause electric shock.

Clean surface of indoor unit

When the surface of indoor unit is dirty, it is recommended to use a soft dry cloth or wet cloth to wipe it.

Note:

- Do not remove the panel when cleaning it.

Clean filter

1. Remove screws of air-in panel
Open screw caps at both sides according to direction ① in fig. 1. Remove the screws at both sides of air-in panel with screwdriver.
2. Open the air-in panel
According the arrow direction ① in fig. 2. Draw out the filter according to arrow direction ②.
3. Clean filter
 - Use dust catcher or water to clean the filter.
 - When the filter is very dirty, use water (below 45 ℃) to clean it, and then put it in a shady and cool place to dry.
4. Install filter and air-in panel
After installing the filter, buckle the air-in panel. Use screwdriver to tighten the screws at both sides of air-in panel, and then install the screw cap.

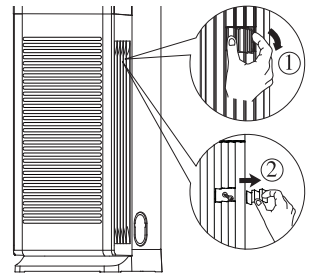

Fig. 1

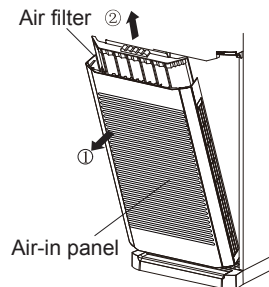

Fig. 2



Note:

- The filter should be cleaned every three months. If there is much dust in the operation environment, cleaning frequency can be increased.
- Do not use fire or hair dryer to dry the filter to avoid deformation or fire hazard.

Clean and maintenance

NOTICE: Checking before use-season

1. Check whether air inlet and air outlet are blocked.
2. Check whether air switch, plug and socket are in good condition.
3. Check whether filter is clean.
4. Check whether the remote controller is installed with batteries.
5. Check whether mounting bracket for outdoor unit is damaged or corroded. If yes, please contact dealer.
6. Check whether drainage pipe is damaged.

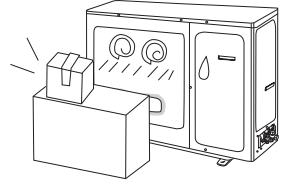

NOTICE: Checking after use-season

1. Disconnect power supply.
2. Clean filter and indoor unit's panel.
3. Clear dust and obstructions from the outdoor unit.
4. Check whether mounting bracket for outdoor unit is damaged or corroded. If yes, please contact dealer.

Notice for recovery

1. Many packing materials are recyclable materials. Please dispose them in appropriate recycling unit.
2. If you want to dispose the air conditioner, please contact local dealer or consultant service center for the correct disposal method.

Malfunction

General phenomenon analysis

Please check below items before asking for maintenance. If the malfunction still can't be eliminated, please contact local dealer or qualified professionals.

Phenomenon	Check items	Solution
Indoor unit can't receive remote controller's signal or remote controller has no action.	<ul style="list-style-type: none"> Whether it's interfered severely (such as static electricity, stable voltage)? 	<ul style="list-style-type: none"> Pull out the plug. Reinsert the plug after about 3min, and then turn on the unit again.
	<ul style="list-style-type: none"> Whether remote controller is within the signal receiving range? 	<ul style="list-style-type: none"> Signal receiving range is 8m.
	<ul style="list-style-type: none"> Whether there are obstacles? 	<ul style="list-style-type: none"> Remove obstacles.
	<ul style="list-style-type: none"> Whether remote controller is pointing at the receiving window? 	<ul style="list-style-type: none"> Select proper angle and point the remote controller at the receiving window on indoor unit.
	<ul style="list-style-type: none"> Is sensitivity of remote controller low; fuzzy display and no display? 	<ul style="list-style-type: none"> Check the batteries. If the power of batteries is too low, please replace them.
	<ul style="list-style-type: none"> No display when operating remote controller? 	<ul style="list-style-type: none"> Check whether remote controller appears to be damaged. If yes, replace it.
	<ul style="list-style-type: none"> Fluorescent lamp in room? 	<ul style="list-style-type: none"> Take the remote controller close to indoor unit. Turn off the fluorescent lamp and then try it again.
Air conditioner can't operate	<ul style="list-style-type: none"> Power failure? 	<ul style="list-style-type: none"> wait until power recovery.
	<ul style="list-style-type: none"> Is plug loose? 	<ul style="list-style-type: none"> Reinsert the plug.
	<ul style="list-style-type: none"> Air switch trips off or fuse is burnt out? 	<ul style="list-style-type: none"> Ask professional to replace air switch or fuse.
	<ul style="list-style-type: none"> Wiring has malfunction? 	<ul style="list-style-type: none"> Ask professional to replace it.
	<ul style="list-style-type: none"> Unit has restarted immediately after stopping operation? 	<ul style="list-style-type: none"> Wait for 3min, and then turn on the unit again.
	<ul style="list-style-type: none"> Whether the function setting for remote controller is correct? 	<ul style="list-style-type: none"> Reset the function.

Malfunction

Phenomenon	Check items	Solution
Mist is emitted from indoor unit's air outlet	<ul style="list-style-type: none"> Indoor temperature and humidity is high? 	<ul style="list-style-type: none"> Because indoor air is cooled rapidly. After a while, indoor temperature and humidity will be decrease and mist will disappear.
No air emitted from indoor unit	<ul style="list-style-type: none"> Air inlet or air outlet of indoor unit is blocked? 	<ul style="list-style-type: none"> Eliminate obstacles.
	<ul style="list-style-type: none"> Under heating mode, indoor temperature is reached to set temperature? 	<ul style="list-style-type: none"> After reaching to set temperature, indoor unit will stop blowing out air.
	<ul style="list-style-type: none"> Heating mode is turned on just now? 	<ul style="list-style-type: none"> In order to prevent blowing out cold air, indoor unit will be started after delaying for several minutes, which is a normal phenomenon.
Set temperature can't be adjusted	<ul style="list-style-type: none"> Unit is operating under auto mode? 	<ul style="list-style-type: none"> Temperature can't be adjusted under auto mode. Please switch the operation mode if you need to adjust temperature.
	<ul style="list-style-type: none"> Your required temperature exceeds the set temperature range? 	<ul style="list-style-type: none"> Set temperature range: 16°C~30°C.
Cooling (heating) effect is not good.	<ul style="list-style-type: none"> Voltage is too low? 	<ul style="list-style-type: none"> Wait until the voltage resumes normal.
	<ul style="list-style-type: none"> Filter is dirty? 	<ul style="list-style-type: none"> Clean the filter.
	<ul style="list-style-type: none"> Set temperature is in proper range? 	<ul style="list-style-type: none"> Adjust temperature to proper range.
	<ul style="list-style-type: none"> Door and window are open? 	<ul style="list-style-type: none"> Close door and window.
Odours are emitted	<ul style="list-style-type: none"> Whether there's odour source, such as furniture and cigarette, etc. 	<ul style="list-style-type: none"> Eliminate the odour source.
		<ul style="list-style-type: none"> Clean the filter.

Malfunction

Phenomenon	Check items	Solution
Air conditioner operates normally suddenly	<ul style="list-style-type: none">• Whether there's interference, such as thunder, wireless devices, etc.	<ul style="list-style-type: none">• Disconnect power, put back power, and then turn on the unit again.
Outdoor unit has vapor	<ul style="list-style-type: none">• Heating mode is turned on?	<ul style="list-style-type: none">• During defrosting under heating mode, it may generate vapor, which is a normal phenomenon.
"Water flowing" noise	<ul style="list-style-type: none">• Air conditioner is turned on or turned off just now?	<ul style="list-style-type: none">• The noise is the sound of refrigerant flowing inside the unit, which is a normal phenomenon.
Cracking noise	<ul style="list-style-type: none">• Air conditioner is turned on or turned off just now?	<ul style="list-style-type: none">• This is the sound of friction caused by expansion and/or contraction of panel or other parts due to the change of temperature.

Malfunction

Error code

- When air conditioner status is abnormal, temperature indicator on indoor unit will blink to display corresponding error code. Please refer to below list for identification of error code.

Error code	Troubleshooting
H3	It can be eliminated after restarting the unit. If not, please contact qualified professionals to deal with it.
H6	It can be eliminated after restarting the unit. If not, please contact qualified professionals to deal with it.
E1	It can be eliminated after restarting the unit. If not, please contact qualified professionals to deal with it.
E3	It can be eliminated after restarting the unit. If not, please contact qualified professionals to deal with it.
E4	It can be eliminated after restarting the unit. If not, please contact qualified professionals to deal with it.
E5	It can be eliminated after restarting the unit. If not, please contact qualified professionals to deal with it.
E6	It can be eliminated after restarting the unit. If not, please contact qualified professionals to deal with it.
E8	It can be eliminated after restarting the unit. If not, please contact qualified professionals to deal with it.
e6	It can be eliminated after restarting the unit. If not, please contact qualified professionals to deal with it.
F0	Please contact qualified professionals to deal with it.
F1	Please contact qualified professionals to deal with it.
F2	Please contact qualified professionals to deal with it.
F3	Please contact qualified professionals to deal with it.
F4	Please contact qualified professionals to deal with it.
F5	Please contact qualified professionals to deal with it.

Note: If there're other error codes, please contact qualified professionals for service.



WARNING

- When below phenomenon occurs, please turn off air conditioner and disconnect power immediately, and then contact the dealer or qualified professionals for service.
 - Power cord is overheating or damaged.
 - There's abnormal sound during operation.
 - Air switch trips off frequently.
 - Air conditioner gives off burning smell.
 - Indoor unit is leaking.
- Do not repair or refit the air conditioner by yourself.
- If the air conditioner operates under abnormal conditions, it may cause malfunction, electric shock or fire hazard.

Safety operation of flammable refrigerant

Qualification requirement for installation and maintenance man

- All the work men who are engaging in the refrigeration system should bear the valid certification awarded by the authoritative organization and the qualification for dealing with the refrigeration system recognized by this industry. If it needs other technician to maintain and repair the appliance, they should be supervised by the person who bears the qualification for using the flammable refrigerant.
- It can only be repaired by the method suggested by the equipment's manufacturer.

Installation notes

- The air conditioner is not allowed to use in a room that has running fire (such as fire source, working coal gas ware, operating heater).
- It is not allowed to drill hole or burn the connection pipe.
- The air conditioner must be installed in a room that is larger than the minimum room area. The minimum room area is shown on the nameplate or following table a.
- Leak test is a must after installation.

table a - Minimum room area (m²)

Minimum room area(m ²)	Charge amount (kg)	≤1.2	1.3	1.4	1.5	1.6	1.7	1.8	1.9	2	2.1	2.2	2.3	2.4	2.5
	floor location	/	14.5	16.8	19.3	22	24.8	27.8	31	34.3	37.8	41.5	45.4	49.4	53.6
window mounted	/	5.2	6.1	7	7.9	8.9	10	11.2	12.4	13.6	15	16.3	17.8	19.3	
wall mounted	/	1.6	1.9	2.1	2.4	2.8	3.1	3.4	3.8	4.2	4.6	5	5.5	6	
ceiling mounted	/	1.1	1.3	1.4	1.6	1.8	2.1	2.3	2.6	2.8	3.1	3.4	3.7	4	

Maintenance notes

- Check whether the maintenance area or the room area meet the requirement of the nameplate.
 - It's only allowed to be operated in the rooms that meet the requirement of the nameplate.
- Check whether the maintenance area is well-ventilated.
 - The continuous ventilation status should be kept during the operation process.
- Check whether there is fire source or potential fire source in the maintenance area.
 - The naked flame is prohibited in the maintenance area; and the "no smoking" warning board should be hanged.
- Check whether the appliance mark is in good condition.
 - Replace the vague or damaged warning mark.

Welding

- If you should cut or weld the refrigerant system pipes in the process of maintaining, please follow the steps as below:

Safety operation of flammable refrigerant

- a. Shut down the unit and cut power supply
 - b. Eliminate the refrigerant
 - c. Vacuuming
 - d. Clean it with N₂ gas
 - e. Cutting or welding
 - f. Carry back to the service spot for welding
- The refrigerant should be recycled into the specialized storage tank.
 - Make sure that there isn't any naked flame near the outlet of the vacuum pump and it's well-ventilated.

Filling the refrigerant

- Use the refrigerant filling appliances specialized for R32. Make sure that different kinds of refrigerant won't contaminate with each other.
- The refrigerant tank should be kept upright at the time of filling refrigerant.
- Stick the label on the system after filling is finished (or haven't finished).
- Don't overfilling.
- After filling is finished, please do the leakage detection before test running; another time of leak detection should be done when it's removed.

Safety instructions for transportation and storage

- Please use the flammable gas detector to check before unload and open the container.
- No fire source and smoking.
- According to the local rules and laws.

Installation dimension diagram

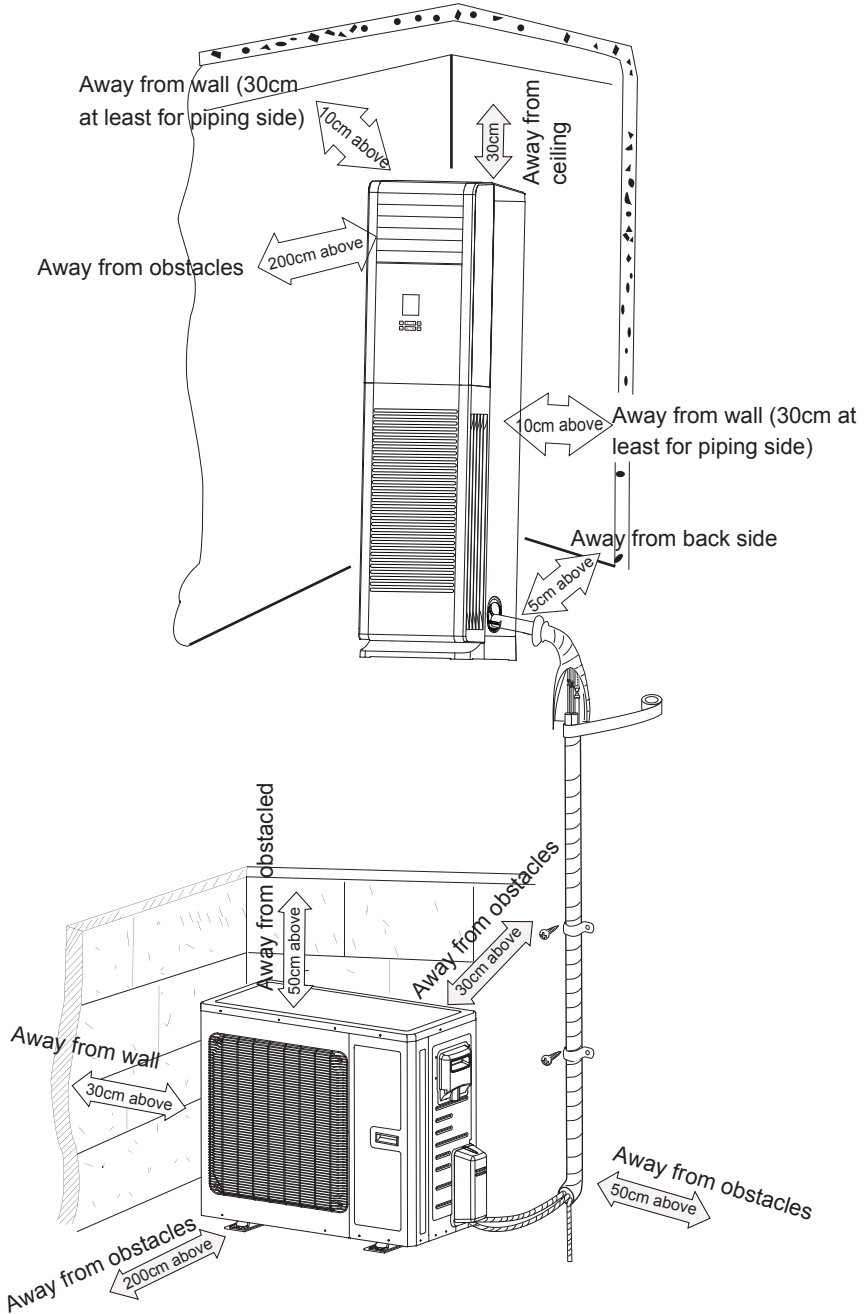

Safety precautions for installing and relocating the unit

To ensure safety, please be mindful of the following precautions.

Warning

- **When installing or relocating the unit, be sure to keep the refrigerant circuit free from air or substances other than the specified refrigerant.**
Any presence of air or other foreign substance in the refrigerant circuit will cause system pressure rise or compressor rupture, resulting in injury.
- **When installing or moving this unit, do not charge the refrigerant which is not comply with that on the nameplate or unqualified refrigerant.**
Otherwise, it may cause abnormal operation, wrong action, mechanical malfunction or even series safety accident.
- **When refrigerant needs to be recovered during relocating or repairing the unit, be sure that the unit is running in cooling mode. Then, fully close the valve at high pressure side (liquid valve). About 30-40 seconds later, fully close the valve at low pressure side (gas valve), immediately stop the unit and disconnect power. Please note that the time for refrigerant recovery should not exceed 1 minute.**
If refrigerant recovery takes too much time, air may be sucked in and cause pressure rise or compressor rupture, resulting in injury.
- **During refrigerant recovery, make sure that liquid valve and gas valve are fully closed and power is disconnected before detaching the connection pipe.**
If compressor starts running when stop valve is open and connection pipe is not yet connected, air will be sucked in and cause pressure rise or compressor rupture, resulting in injury.
- **When installing the unit, make sure that connection pipe is securely connected before the compressor starts running.**
If compressor starts running when stop valve is open and connection pipe is not yet connected, air will be sucked in and cause pressure rise or compressor rupture, resulting in injury.
- **Prohibit installing the unit at the place where there may be leaked corrosive gas or flammable gas.**
If there leaked gas around the unit, it may cause explosion and other accidents.
- **Do not use extension cords for electrical connections. If the electric wire is not long enough, please contact a local service center authorized and ask for a proper electric wire.**
Poor connections may lead to electric shock or fire.
- **Use the specified types of wires for electrical connections between the indoor and outdoor units. Firmly clamp the wires so that their terminals receive no external stresses.**
Electric wires with insufficient capacity, wrong wire connections and insecure wire terminals may cause electric shock or fire.

Tools for installation

1 Level meter	2 Screw driver	3 Impact drill
4 Drill head	5 Pipe expander	6 Torque wrench
7 Open-end wrench	8 Pipe cutter	9 Leakage detector
10 Vacuum pump	11 Pressure meter	12 Universal meter
13 Inner hexagon spanner		14 Measuring tape

Note:

- Please contact the local agent for installation.
- Don't use unqualified power cord.

Selection of installation location

Basic requirements

Installing the unit in the following places may cause malfunction. If it is unavoidable, please consult the local dealer:

1. The place near strong heat sources vapors, flammable or explosive gas, or volatile objects spread in the air.
2. The place with high-frequency devices (such as welding machine, medical equipment).
3. The place near coast area.
4. The place with oil or fumes in the air.
5. The place with sulfureted gas.
6. Other places with special circumstances.
7. Please try your best to keep way from fluorescent lamp.
8. It's not allowed to be installed on the unstable or motive base structure (such as truck) or in the corrosive environment (such as chemical factory).

Indoor unit

1. Avoid installing the indoor unit in a place where generated or leaked inflammable gas will stay.
2. Avoid installing the indoor unit in a moist place or in a place where oil may be splashed on the unit.
3. Select a location where outlet air may reach each corner of the room.
4. Select a location where connection pipe can be led to outdoor conveniently.
5. Select a location where air inlet and outlet won't be blocked.
6. Select a location with least affection of outdoor air.
7. Select a location with firm and flat floor.
8. Retain sufficient space for maintenance and installation.
9. Ensure the installation meets the requirement of installation dimension diagram.
10. Do not use the unit in the immediate surroundings of a laundry, a bath, a shower or a swimming pool.

Outdoor unit

1. Select a location where the noise and outflow air emitted by the outdoor unit will not affect neighborhood.
2. The location should be well ventilated and dry, in which the outdoor unit won't be exposed directly to sunlight or strong wind.
3. The location should be able to withstand the weight of outdoor unit.
4. Make sure that the installation follows the requirement of installation dimension diagram.
5. Select a location which is out of reach for children and far away from animals or plants. If it is unavoidable, please add fence for safety purpose.
6. The height difference between indoor unit and outdoor unit should be within 5m. The length of connection pipe should be within 10m.

Requirements for electric connection

Safety precaution

1. Must follow the electric safety regulations when installing the unit.
2. If the supply cord is damaged, it must be replaced by the manufacturer or its service agent or a similarly qualified person in order to avoid a hazard.
3. According to the local safety regulations, use qualified power supply circuit and air switch.
4. A air switch having a contact separation of at least 3mm in all poles should be fixed in fixed wiring.
5. The appliance shall be installed in accordance with national wiring regulation.
6. The air switch must have the functions of magnetic tripping and heat tripping in order to prevent short circuit or overload. Please install the air switch with suitable capacity according to the sheet below.
7. Make sure the power supply matches with the requirement of air conditioner. Unstable power supply or incorrect wiring may result in electric shock, fire hazard or malfunction. Please install proper power supply cables before using the air conditioner.
8. Properly connect the live wire, neutral wire and grounding wire of power socket.
9. Be sure to cut off the power supply before proceeding any work related to electric safety.
10. Do not put through the power before finishing installation.

Grounding requirement

1. The air conditioner is first class electric appliance. It must be properly grounded with specialized grounding device by a professional. Please make sure it is always grounded effectively, otherwise it may cause electric shock.
2. The yellow-green wire in air conditioner is grounding wire, which can't be used for other purposes.
3. The grounding resistance should comply with national electric safety regulations.
4. Including an air switch with suitable capacity, please note the following table. Air switch should be included magnet buckle and heating buckle function, it can protect the circuit-short and overload. (Caution: please do not use the fuse only for protect the circuit)

Air-conditioner	Air switch capacity
48K	16A

Installation of indoor unit

Step one: choosing installation location

Recommend the installation location to the client and then confirm it with the client.

Step two: open piping hole

1. Choose the position of piping hole according to the direction of outlet pipe.
2. Open a piping hole with the diameter of $\Phi 70$ on the selected outlet pipe position. In order to drain smoothly, slant the piping hole on the wall slightly downward to the outdoor side with the gradient of $5-10^\circ$.

Note:

- Pay attention to dust prevention and take relevant safety measures when opening the hole.

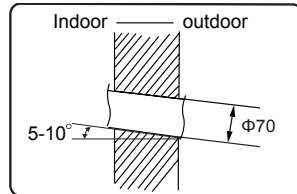

Step three: outlet pipe

1. The pipe can be led out in the direction of left, right or rear.
2. After confirming the direction of outlet pipe, loosen the screws at the upper and lower adjusting baffle to let the connection pipe /drain pipe connects the indoor unit.

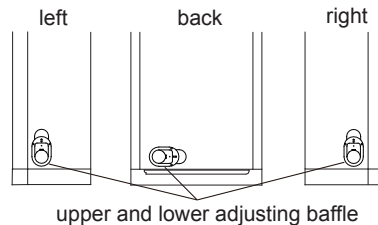
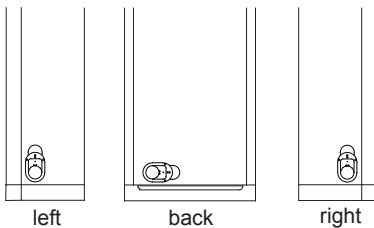

Step four: connect the pipe of indoor unit

1. Take out the left and right screw cover and then remove the screws on air-inlet panel to remove the panel.

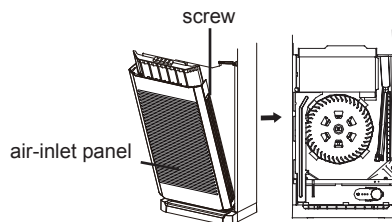

Installation of indoor unit

2. Aim the pipe joint at the corresponding bellmouth.

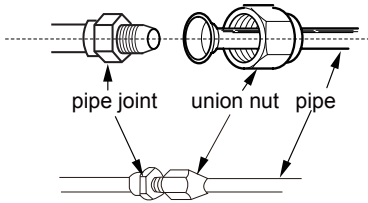

3. Pretighten the union nut with hand.
4. Adjust the torque force by referring to the following sheet. Place the open-end wrench on the pipe joint and place the torque wrench on the union nut. Tighten the union nut with torque wrench.

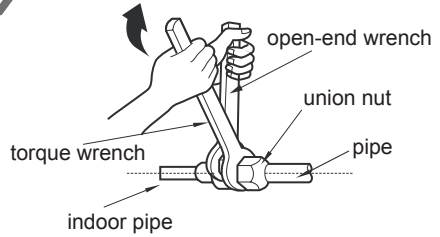

Hex nut diameter	Tightening torque (N·m)
1/4"	15.7 (1.6kg·m)
3/8"	29.4 (3.0kg·m)
1/2"	49.0 (5.0kg·m)
5/8"	73.6 (7.5kg·m)

5. Wrap the indoor pipe and joint of connection pipe with insulating pipe, and then wrap it with tape.

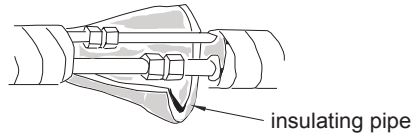

Step five: install drain hose

1. Connect the drain hose to the outlet pipe of indoor unit.

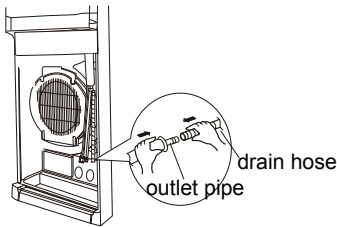

2. Bind the joint with tape.

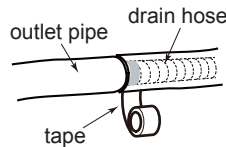

Note:

- Add insulating pipe in the indoor drain hose in order to prevent condensation.

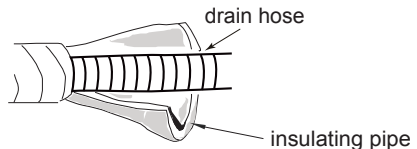

Step six: connect wire of indoor unit

1. Make the power connection wire go through the cable-cross hole of indoor unit and then pull it out.

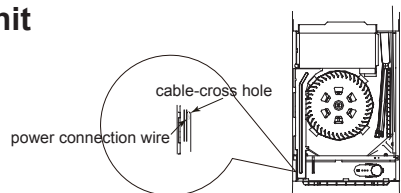

Installation of indoor unit

2. Remove the wire clip; connect the power connection wire to the wiring terminal according to the color; tighten the screw and then fix the power connection wire with wire clip.

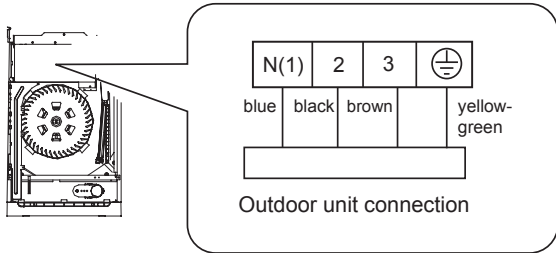

3. Adjust the position of upper and lower adjusting baffle; clamp the connection pipe and drain pipe as firm as possible.
4. Tighten the screws.

Note:

All wires of indoor unit and outdoor unit should be connected by a professional.

- If the length of power connection wire is insufficient, please contact the supplier for a new one. Avoid extending the wire by yourself.
- For the air conditioner with plug, the plug should be reachable after finishing installation.
- For the air conditioner without plug, an air switch must be installed in the line. The air switch should be all-pole parting and the contact parting distance should be more than 3mm.

Step seven: bind up pipe

1. Bind up the connection pipe, power cord and drain hose with the band.

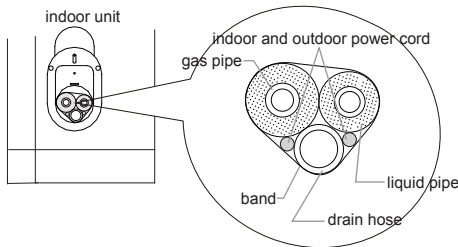

Installation of indoor unit

2. Reserve a certain length of drain hose and power cord for installation when binding them. When binding to a certain degree, separate the indoor power and then separate the drain hose.

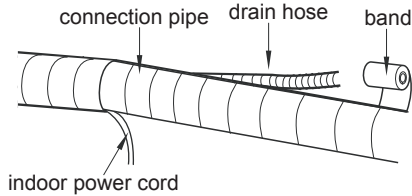

3. Wrap it evenly, and rolling width should be 1/3 of bandaging belt. Do not wrap it too tight or too loose.
4. The liquid pipe and gas pipe should be bound separately at the end.

Note:

- The power cord and control wire can't be crossed or winding.
- The drain hose should be bound at the bottom.

Step eight: place the indoor unit

1. Put the bound pipes in the wall pipe and then make them pass through the wall hole.
2. Stuff the gap between pipes and wall hole with sealing gum.
3. Fix the wall pipe.

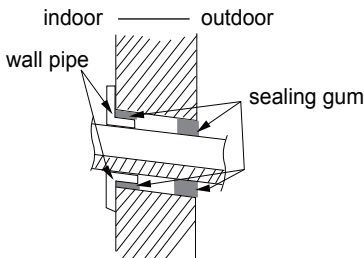

Note:

- Do not bend the drain hose too excessively in order to prevent blocking.

Installation of outdoor unit

Step one: fix the support of outdoor unit

(select it according to the actual installation situation)

1. Select installation location according to the house structure.
2. Fix the support of outdoor unit on the selected location with expansion screws.

Note:

- Take sufficient protective measures when installing the outdoor unit.
- Make sure the support can withstand at least four times of the unit weight.
- The outdoor unit should be installed at least 3cm above the floor in order to install drain joint. (for the model with heating tube, the installation height should be no less than 20cm.)
- For the unit with cooling capacity of 2300W ~5000W, 6 expansion screws are needed; for the unit with cooling capacity of 6000W ~8000W, 8 expansion screws are needed; for the unit with cooling capacity of 10000W ~16000W, 10 expansion screws are needed.

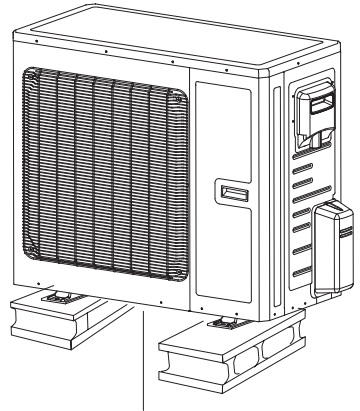

at least 3cm above the floor

Step two: install drain joint (Only for some models)

1. Connect the outdoor drain joint into the hole on the chassis, as shown in the picture below.
2. Connect the drain hose into the drain vent.

NOTE: As for the shape of drainage joint, please refer to the current product. Do not install the drainage joint in the severe cold area. Otherwise, it will be frosted and then cause malfunction.

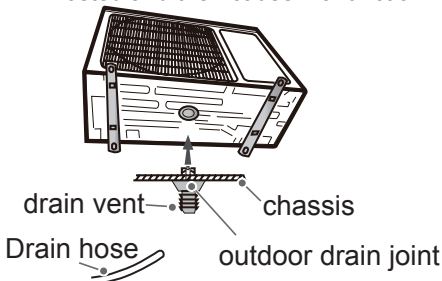

Step three: fix outdoor unit

1. Place the outdoor unit on the support.
2. Fix the foot holes of outdoor unit with bolts.

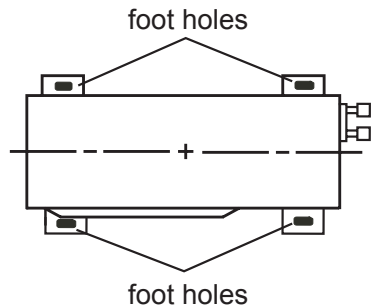

Installation of outdoor unit

Step four: connect indoor and outdoor pipes

1. Remove the front side plate or handle.

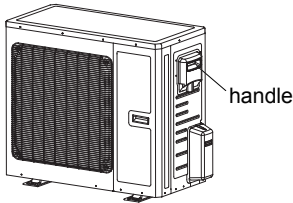

2. Remove the screw cap of valve and aim the pipe joint at the bellmouth of pipe.

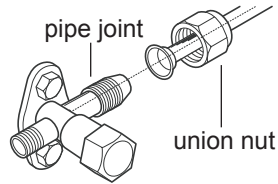
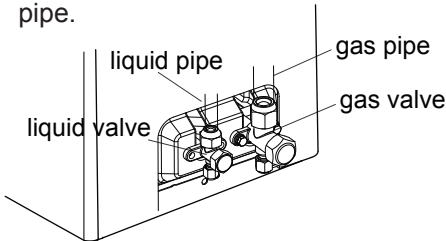

3. Pretighten the union nut with hand.
4. Tighten the union nut with torque wrench by referring to the sheet below.

Hex nut diameter	Tightening torque (N.m)
1/4"	15.7 (1.6kg.m)
3/8"	29.4 (3.0kg.m)
1/2"	49 (5.0kg.m)
5/8"	73.6 (7.5kg.m)

Step five: connect outdoor electric wire

1. Remove the wire clip; connect the power connection wire and signal control wire (only for cooling and heating unit) to the wiring terminal according to the color; fix them with screws.

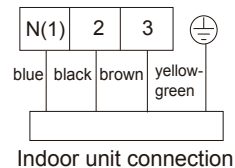
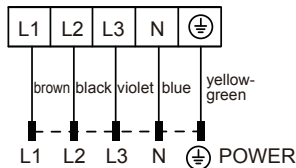
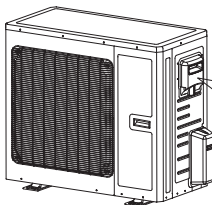

Installation of outdoor unit

2. Fix the power connection wire and signal control wire with wire clip (only for cooling and heating unit).

Note:

- After tightening the screw, pull the power cord slightly to check if it is firm.
- Never cut the power connection wire to prolong or shorten the distance.

Step six: neatn the pipes

1. The pipes should be placed along the wall, bent reasonably and hidden possibly. Min. semidiameter of bending the pipe is 10cm.
2. If the outdoor unit is higher than the wall hole, you must set a U-shaped curve in the pipe before pipe goes into the room, in order to prevent rain from getting into the room.

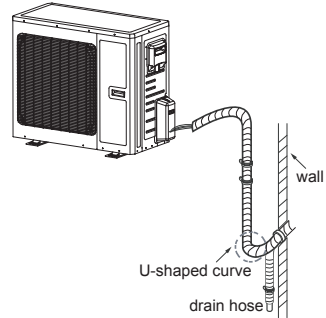

Note:

- The through-wall height of drain hose shouldn't be higher than the outlet pipe hole of indoor unit.
- Slant the drain hose slightly downwards. The drain hose can't be curved, raised and fluctuant, etc.

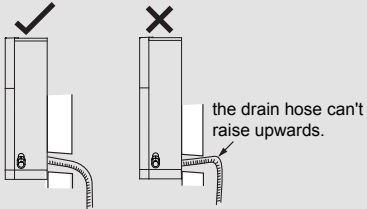

- The water outlet can't be placed in water in order to drain smoothly.

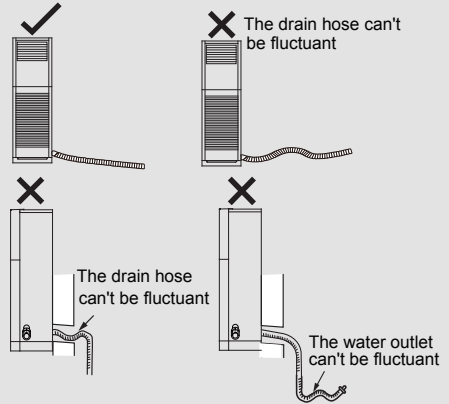
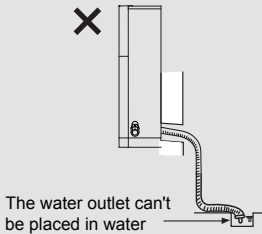

Vacuum pumping

Use vacuum pump

1. Remove the valve caps on the liquid valve and gas valve and the nut of refrigerant charging vent.
2. Connect the charging hose of piezo-meter to the refrigerant charging vent of gas valve and then connect the other charging hose to the vacuum pump.
3. Open the piezometer completely and operate for 10-15min to check if the pressure of piezometer remains in -0.1MPa .
4. Close the vacuum pump and maintain this status for 1-2min to check if the pressure of piezometer remains in -0.1MPa . If the pressure decreases, there may be leakage.
5. Remove the piezometer, open the valve core of liquid valve and gas valve completely with inner hexagon spanner.
6. Tighten the screw caps of valves and refrigerant charging vent.
7. Reinstall the handle.

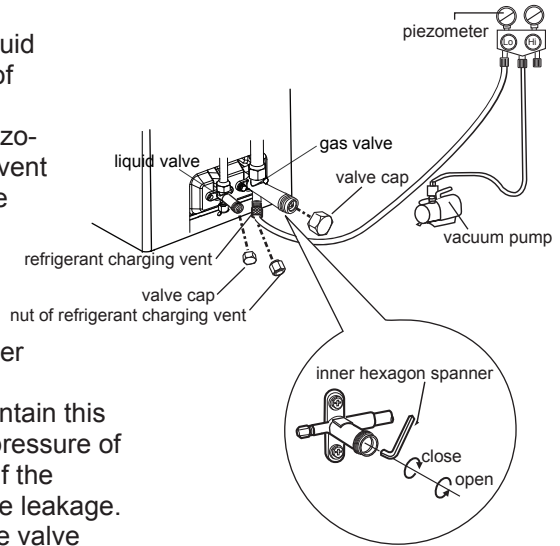

Leakage detection

1. With leakage detector
Check if there is leakage with leakage detector.
2. With soap water
If leakage detector is not available, please use soap water for leakage detection. Apply soap water at the suspected position and keep the soap water for more than 3min. If there are air bubbles coming out of this position, there's a leakage.

Check after installation

- Check according to the following requirement after finishing installation.

Items to be checked	Possible malfunction
Has the unit been installed firmly?	The unit may drop, shake or emit noise.
Have you done the refrigerant leakage test?	It may cause insufficient cooling (heating) capacity.
Is heat insulation of pipeline sufficient?	It may cause condensation and water dripping.
Is water drained well?	It may cause condensation and water dripping.
Is the voltage of power supply according to the voltage marked on the nameplate?	It may cause malfunction or damaging the parts.
Is electric wiring and pipeline installed correctly?	It may cause malfunction or damaging the parts.
Is the unit grounded securely?	It may cause electric leakage.
Does the power cord follow the specification?	It may cause malfunction or damaging the parts.
Is there any obstruction in the air inlet and outlet?	It may cause insufficient cooling (heating) capacity.
The dust and sundries caused during installation are removed?	It may cause malfunction or damaging the parts.
The gas valve and liquid valve of connection pipe are open completely?	It may cause insufficient cooling (heating) capacity.
Is the inlet and outlet of piping hole been covered?	It may cause insufficient cooling (heating) capacity or waste electricity.

Test operation

1. Preparation of test operation

- The client approves the air conditioner.
- Specify the important notes for air conditioner to the client.

2. Method of test operation

- Put through the power, press ON/OFF button on the remote controller to start operation.
- Press MODE button to select AUTO, COOL, DRY, FAN and HEAT to check whether the operation is normal or not.
- If the ambient temperature is lower than 16°C , the air conditioner can't start cooling.

Installation instructions of anti-collapse chain

- In order to prevent accidental collapse of indoor unit, please install the anti-collapse chain.

Installation steps:

1. Remove the screw of anti-collapse hole at the top cover of indoor unit (see fig. 3);
2. Take out the anti-collapse chain and put it into the anti-collapse hole, and then tighten it with screw (see fig. 4);
3. Fix the other end of anti-collapse chain on the wall with screw (ST4.2X38) (see fig. 4).

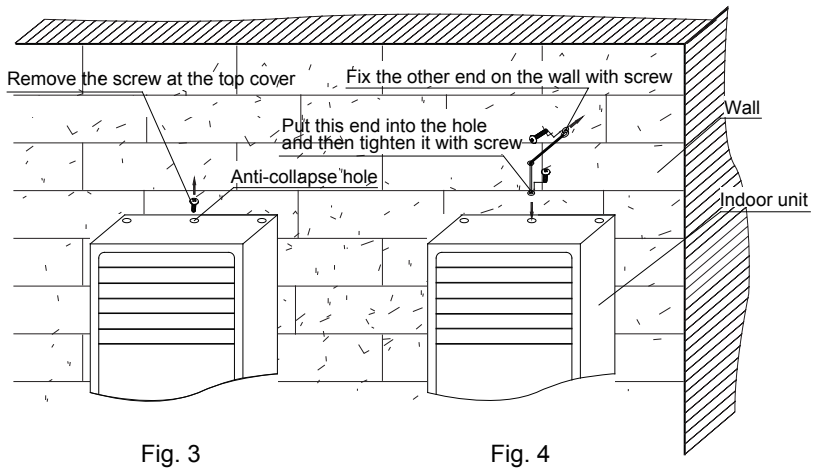

Fig. 3

Fig. 4

- The above fig may be different from the actual products; please refer to the actual products.

Configuration of connection pipe

1. Standard length of connection pipe

- 5m、7.5m、8m

2. Min. length of connection pipe

For the unit with standard connection pipe of 5m, there is no limitation for the min. length of connection pipe. For the unit with standard connection pipe of 7.5m and 8m, the min. length of connection pipe is 3m.

3. Max. length of connection pipe

Sheet 1 Max. length of connection pipe

Unit: m

capacity	Max. length of connection pipe	capacity	Max. length of connection pipe
5000Btu/h (1465W)	15	24000Btu/h (7032W)	25
7000Btu/h (2051W)	15	28000Btu/h (8204W)	30
9000Btu/h (2637W)	15	36000Btu/h (10548W)	30
12000Btu/h (3516W)	20	42000Btu/h (12306W)	30
18000Btu/h (5274W)	25	48000Btu/h (14064W)	30

4. The calculation method of additional refrigerant oil and refrigerant charging amount after prolonging connection pipe

After the length of connection pipe is prolonged for 10m at the basis of standard length, you should add 5ml of refrigerant oil for each additional 5m of connection pipe.

The calculation method of additional refrigerant charging amount (on the basis of liquid pipe):

- (1) Additional refrigerant charging amount= prolonged length of liquid pipe × additional refrigerant charging amount per meter
- (2) Basing on the length of standard pipe, add refrigerant according to the requirement as shown in the table. The additional refrigerant charging amount per meter is different according to the diameter of liquid pipe. See Sheet 2.

Configuration of connection pipe

Sheet 2. Additional refrigerant charging amount for R32

Piping size		Indoor unit throttle	Outdoor unit throttle	
Liquid pipe	Gas pipe	Cooling only, cooling and heating (g / m)	Cooling only (g / m)	cooling and heating (g / m)
1/4"	3/8" or 1/2"	16	12	16
1/4" or 3/8"	5/8" or 3/4"	40	12	40
1/2"	3/4" or 7/8"	80	24	96
5/8"	1" or 1 1/4"	136	48	96
3/4"	—	200	200	200
7/8"	—	280	280	280

Note: The additional refrigerant charging amount in Sheet 2 is recommended value, not compulsory.

5. If the outdoor unit is higher than the indoor unit for more than 5m, an oil return bend is needed.

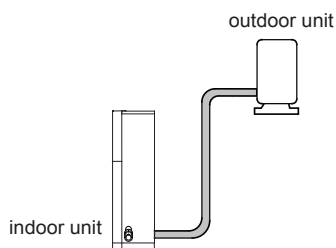

Below 5m

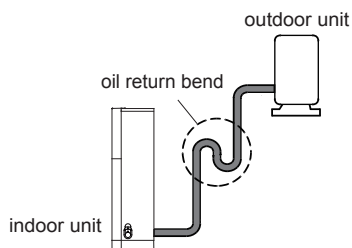

Above 5m

Pipe expanding method

Note:

Improper pipe expanding is the main cause of refrigerant leakage. Please expand the pipe according to the following steps:

A: Cut the pipe

- Confirm the pipe length according to the distance of indoor unit and outdoor unit.
- Cut the required pipe with pipe cutter.

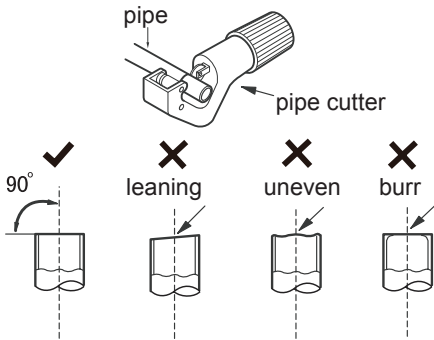

B: Remove the burrs

- Remove the burrs with shaper and prevent the burrs from getting into the pipe.

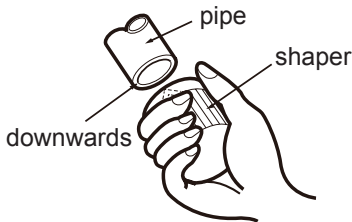

C: Put on suitable insulating pipe

D: Put on the union nut

- Remove the union nut on the indoor connection pipe and outdoor valve; install the union nut on the pipe.

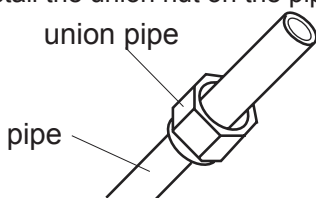

E: Expand the port

- Expand the port with expander.

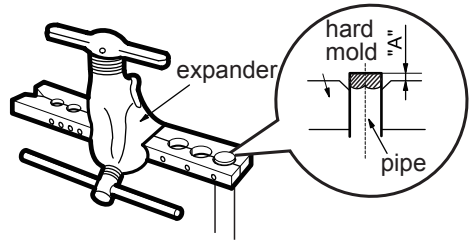

Note:

- "A" is different according to the diameter, please refer to the sheet below:

Outer diameter (mm)	A(mm)	
	Max	Min
Φ6-6.35(1/4")	1.3	0.7
Φ9-9.52(3/8")	1.6	1.0
Φ12-12.7(1/2")	1.8	1.0
Φ15.8-16(5/8")	2.4	2.2

F: Inspection

- Check the quality of expanding port. If there is any blemish, expand the port again according to the steps above.

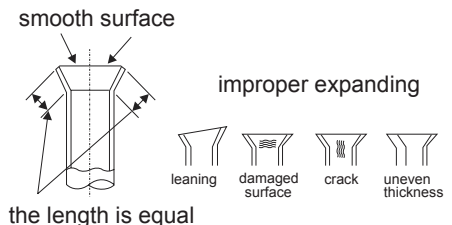

Specialist's Manual

- **The following checks shall be applied to installations using flammable refrigerants:**
 - the charge size is in accordance with the room size within which the refrigerant containing parts are installed;
 - the ventilation machinery and outlets are operating adequately and are not obstructed;
 - if an indirect refrigerating circuit is being used, the secondary circuit shall be checked for the presence of refrigerant;
 - marking to the equipment continues to be visible and legible. Markings and signs that are illegible shall be corrected;
 - refrigeration pipe or components are installed in a position where they are unlikely to be exposed to any substance which may corrode refrigerant containing components, unless the components are constructed of materials which are inherently resistant to being corroded or are suitably protected against being so corroded.
- **Repair and maintenance to electrical components shall include initial safety checks and component inspection procedures. If a fault exists that could compromise safety, then no electrical supply shall be connected to the circuit until it is satisfactorily dealt with. If the fault cannot be corrected immediately but it is necessary to continue operation, an adequate temporary solution shall be used. This shall be reported to the owner of the equipment so all parties are advised.**
- **Initial safety checks shall include:**
 - that capacitors are discharged: this shall be done in a safe manner to avoid possibility of sparking;
 - that no live electrical components and wiring are exposed while charging, recovering or purging the system;
 - that there is continuity of earth bonding.
- **Checking for presence of refrigerant**

The area shall be checked with an appropriate refrigerant detector prior to and during work, to ensure the technician is aware of potentially toxic or flammable atmospheres. Ensure that the leak detection equipment being used is suitable for use with all applicable refrigerants, i.e. non-sparking, adequately sealed or intrinsically safe.
- **Presence of fire extinguisher**

If any hot work is to be conducted on the refrigeration equipment or any associated parts, appropriate fire extinguishing equipment shall be available to hand. Have a dry powder or CO₂ fire extinguisher adjacent to the charging area.
- **Ventilated area**

Ensure that the area is in the open or that it is adequately ventilated before breaking into the system or conducting any hot work. A degree of ventilation shall continue during the period that the work is carried out. The ventilation should safely disperse any released refrigerant and preferably expel it externally into the atmosphere.
- **Leak detection methods**

Leak detection fluids are suitable for use with most refrigerants but the use of detergents containing chlorine shall be avoided as the chlorine may react with the refrigerant and corrode the copper pipe-work.

Specialist's Manual

● Checks to the refrigeration equipment

Where electrical components are being changed, they shall be fit for the purpose and to the correct specification. At all times the manufacturer's maintenance and service guidelines shall be followed. If in doubt, consult the manufacturer's technical department for assistance.

● Checks to electrical devices

- that capacitors are discharged: this shall be done in a safe manner to avoid possibility of sparking;
- that no live electrical components and wiring are exposed while charging, recovering or purging the system.

● Repairs to sealed components

During repairs to sealed components, all electrical supplies shall be disconnected from the equipment being worked upon prior to any removal of sealed covers, etc. If it is absolutely necessary to have an electrical supply to equipment during servicing, then a permanently operating form of leak detection shall be located at the most critical point to warn of a potentially hazardous situation.

Particular attention shall be paid to the following to ensure that by working on electrical components, the casing is not altered in such a way that the level of protection is affected. This shall include damage to cables, excessive number of connections, terminals not made to original specification, damage to seals, incorrect fitting of glands, etc.

- Ensure that the apparatus is mounted securely.
- Ensure that seals or sealing materials have not degraded to the point that they no longer serve the purpose of preventing the ingress of flammable atmospheres. Replacement parts shall be in accordance with the manufacturer's specifications.

NOTE: The use of silicon sealant can inhibit the effectiveness of some types of leak detection equipment. Intrinsically safe components do not have to be isolated prior to working on them.

● Repair to intrinsically safe components

Do not apply any permanent inductive or capacitance loads to the circuit without ensuring that this will not exceed the permissible voltage and current permitted for the equipment in use.

Intrinsically safe components are the only types that can be worked on while live in the presence of a flammable atmosphere. The test apparatus shall be at the correct rating.

Replace components only with parts specified by the manufacturer. Other parts may result in the ignition of refrigerant in the atmosphere from a leak.

● Cabling

Check that cabling will not be subject to wear, corrosion, excessive pressure, vibration, sharp edges or any other adverse environmental effects. The check shall also take into account the effects of aging or continual vibration from sources such as compressors or fans.

● Detection of flammable refrigerants

Under no circumstances shall potential sources of ignition be used in the searching for or detection of refrigerant leaks. A halide torch (or any other detector using a naked flame) shall not be used.

Specialist's Manual

● Decommissioning

Before carrying out this procedure, it is essential that the technician is completely familiar with the equipment and all its detail. It is recommended good practice that all refrigerants are recovered safely. Prior to the task being carried out, an oil and refrigerant sample shall be taken in case analysis is required prior to re-use of reclaimed refrigerant. It is essential that electrical power is available before the task is commenced.

a) Become familiar with the equipment and its operation.

b) Isolate system electrically.

c) Before attempting the procedure, ensure that:

- mechanical handling equipment is available, if required, for handling refrigerant cylinders;
- all personal protective equipment is available and being used correctly;
- the recovery process is supervised at all times by a competent person;
- recovery equipment and cylinders conform to the appropriate standards.

d) Pump down refrigerant system, if possible.

e) If a vacuum is not possible, make a manifold so that refrigerant can be removed from various parts of the system.

f) Make sure that cylinder is situated on the scales before recovery takes place.

g) Start the recovery machine and operate in accordance with manufacturer's instructions.

h) Do not overfill cylinders. (No more than 80% volume liquid charge).

i) Do not exceed the maximum working pressure of the cylinder, even temporarily.

j) When the cylinders have been filled correctly and the process completed, make sure that the cylinders and the equipment are removed from site promptly and all isolation valves on the equipment are closed off.

k) Recovered refrigerant shall not be charged into another refrigeration system unless it has been cleaned and checked.

● Labelling

Equipment shall be labelled stating that it has been de-commissioned and emptied of refrigerant. The label shall be dated and signed. For appliances containing flammable refrigerants, ensure that there are labels on the equipment stating the equipment contains flammable refrigerant.

● Recovery

When removing refrigerant from a system, either for servicing or decommissioning, it is recommended good practice that all refrigerants are removed safely.

When transferring refrigerant into cylinders, ensure that only appropriate refrigerant recovery cylinders are employed. Ensure that the correct number of cylinders for holding the total system charge are available. All cylinders to be used are designated for the recovered refrigerant and labelled for that refrigerant (i.e. special cylinders for the recovery of refrigerant). Cylinders shall be complete with pressure-relief valve and associated shut-off valves in good working order. Empty recovery cylinders are evacuated and, if possible, cooled before recovery occurs.

The recovery equipment shall be in good working order with a set of instructions concerning the equipment that is at hand and shall be suitable for the recovery of all appropriate refrigerants including, when applicable, flammable refrigerants. In addition, a set of calibrated weighing scales shall be available and in good working order. Hoses shall be complete with leak-free disconnect couplings and in good condition. Before using the recovery machine, check that it is in satisfactory working

Specialist's Manual

order, has been properly maintained and that any associated electrical components are sealed to prevent ignition in the event of a refrigerant release. Consult manufacturer if in doubt.

The recovered refrigerant shall be returned to the refrigerant supplier in the correct recovery cylinder, and the relevant waste transfer note arranged. Do not mix refrigerants in recovery units and especially not in cylinders.

If compressors or compressor oils are to be removed, ensure that they have been evacuated to an acceptable level to make certain that flammable refrigerant does not remain within the lubricant. The evacuation process shall be carried out prior to re- turning the compressor to the suppliers. Only electric heating to the compressor body shall be employed to accelerate this process. When oil is drained from a system, it shall be carried out safely.

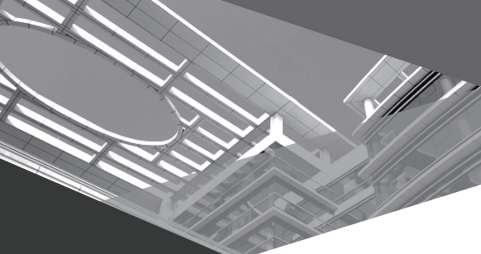

GREE ELECTRIC APPLIANCES, INC. OF ZHUHAI

Add: West Jinji Rd, Qianshan, Zhuhai, Guangdong, China, 519070

Tel: (+86-756) 8522218

Fax: (+86-756) 8669426

E-mail: global@cn.gree.com

Web: www.gree.com



600005063722