

Revision A:

- MXZ-2HA40/50VF-**E2** and MXZ-3HA50VF-**E2** have been added.

OBB828 is void.

OUTDOOR UNIT

SERVICE MANUAL



**No. OBH828
REVISED EDITION-A**

Models

MXZ-2HA40VF - **E1**, **ET1**, **E2**

MXZ-2HA50VF - **E1**, **ET1**, **E2**

MXZ-3HA50VF - **E1**, **ET1**, **E2**

Indoor unit service manual
MSZ-HR•VF Series (OBH822)

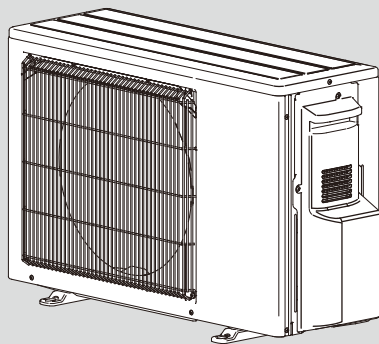

MXZ-2HA40VF
MXZ-2HA50VF

CONTENTS

1. TECHNICAL CHANGES	3
2. SAFETY PRECAUTION.....	3
3. PART NAMES AND FUNCTIONS.....	13
4. SPECIFICATION	14
5. NOISE CRITERIA CURVES.....	17
6. OUTLINES AND DIMENSIONS.....	18
7. WIRING DIAGRAM.....	20
8. REFRIGERANT SYSTEM DIAGRAM	24
9. PERFORMANCE CURVES	27
10. ACTUATOR CONTROL	36
11. SERVICE FUNCTIONS.....	37
12. TROUBLESHOOTING	41
13. DISASSEMBLY INSTRUCTIONS.....	66

PARTS CATALOG (OBB828)

Use the specified refrigerant only

Never use any refrigerant other than that specified.

Doing so may cause a burst, an explosion, or fire when the unit is being used, serviced, or disposed of.

Correct refrigerant is specified in the manuals and on the spec labels provided with our products.

We will not be held responsible for mechanical failure, system malfunction, unit breakdown or accidents caused by failure to follow the instructions.

<Preparation before the repair service>

- Prepare the proper tools.
- Prepare the proper protectors.
- Provide adequate ventilation.
- After stopping the operation of the air conditioner, turn off the power-supply breaker and remove the power plug.
- Discharge the capacitor before the work involving the electric parts.

<Precautions during the repair service>



- Do not perform the work involving the electric parts with wet hands.
- Do not pour water into the electric parts.
- Do not touch the refrigerant.
- Do not touch the hot or cold areas in the refrigeration cycle.
- When the repair or the inspection of the circuit needs to be done without turning off the power, exercise great caution not to touch the live parts.

WARNING

When the refrigeration circuit has a leak, do not execute pump down with the compressor.

When pumping down the refrigerant, stop the compressor before disconnecting the refrigerant pipes. The compressor may burst if air etc. get into it.

Revision A:

- MXZ-2HA40/50VF- and MXZ-3HA50VF- have been added.

1

TECHNICAL CHANGES

MXZ-2HA40VF -E1, E1

MXZ-2HA50VF -E1, E1

MXZ-3HA50VF -E1, E1

1. New model

MXZ-2HA40VF -E1 → **MXZ-2HA40VF** -E2

MXZ-2HA50VF -E1 → **MXZ-2HA50VF** -E2





MXZ-3HA50VF -E1 → **MXZ-3HA50VF** -E2

1. Model name has been changed.

2

SAFETY PRECAUTION

MEANINGS OF SYMBOLS DISPLAYED ON THE UNIT

	WARNING (Risk of fire)	This mark is for R32 refrigerant only. Refrigerant type is written on nameplate of outdoor unit. In case that refrigerant type is R32, this unit uses a flammable refrigerant. If refrigerant leaks and comes in contact with fire or heating part, it will create harmful gas and there is risk of fire.
	Read the OPERATION MANUAL carefully before operation.	
	Service personnel are required to carefully read the OPERATION MANUAL and INSTALLATION MANUAL before operation.	
	Further information is available in the OPERATION MANUAL, INSTALLATION MANUAL, and the like.	

2-1. ALWAYS OBSERVE FOR SAFETY

Before obtaining access to terminal, all supply circuits must be disconnected.

2-2. CAUTIONS RELATED TO NEW REFRIGERANT

Cautions for units utilizing refrigerant R32

Preparation before the repair service.

- Prepare the proper tools.
- Prepare the proper protectors.
- Provide adequate ventilation.
- After stopping the operation of the air conditioner, turn off the power-supply breaker.
- Discharge the condenser before the work involving the electric parts.

Use new refrigerant pipes.

- In case of using the existing pipes for R22, be careful with the following.
- Be sure to clean the pipes and make sure that the insides of the pipes are clean.
 - Change flare nut to the one provided with this product.
Use a newly flared pipe.
 - Avoid using thin pipes.

Precautions during the repair service.

- Do not perform the work involving the electric parts with wet hands.
- Do not pour water into the electric parts.
- Do not touch the refrigerant.
- Do not touch the hot or cold areas in the refrigerating cycle.
- When the repair or the inspection of the circuit needs to be done without turning off the power, exercise great caution not to touch the live parts.

Use a vacuum pump with a reverse flow check valve.

Vacuum pump oil may flow back into refrigerant cycle and that can cause deterioration of refrigerant oil, etc.

Make sure that the inside and outside of refrigerant piping is clean and it has no contaminants such as sulfur, oxides, dirt, shaving particles, etc, which are hazard to refrigerant cycle. In addition, use pipes with specified thickness.

Contamination inside refrigerant piping can cause deterioration of refrigerant oil, etc.

Store the piping indoors, and both ends of the piping sealed until just before brazing. (Leave elbow joints, etc. in their packaging.)

If dirt, dust or moisture enters into refrigerant cycle, that can cause deterioration of refrigerant oil or malfunction of compressor.

The refrigerant oil applied to flare and flange connections must be ester oil, ether oil or alkylbenzene oil in a small amount.

If large amount of mineral oil enters, that can cause deterioration of refrigerant oil, etc.

Do not use refrigerant other than R32.

If other refrigerant (R22, etc.) is used, chlorine in refrigerant can cause deterioration of refrigerant oil, etc.

Use the following tools specifically designed for use with R32 refrigerant.

The following tools are necessary to use R32 refrigerant.

Tools for R32	
Gauge manifold	Flare tool
Charge hose	Size adjustment gauge
Gas leak detector	Vacuum pump adaptor
Torque wrench	Electronic refrigerant charging scale

Handle tools with care.

If dirt, dust or moisture enters into refrigerant cycle, that can cause deterioration of refrigerant oil or malfunction of compressor.

Use the specified refrigerant only.

Never use any refrigerant other than that specified.

Doing so may cause a burst, an explosion, or fire when the unit is being used, serviced, or disposed of.

Correct refrigerant is specified in the manuals and on the spec labels provided with our products.

We will not be held responsible for mechanical failure, system malfunction, unit breakdown or accidents caused by failure to follow the instructions.

Ventilate the room if refrigerant leaks during operation. If refrigerant comes into contact with a flame, poisonous gases will be released.

[1] Warning for service

- (1) Do not alter the unit.
- (2) For installation and relocation work, follow the instructions in the Installation Manual and use tools and pipe components specifically made for use with refrigerant specified in the outdoor unit installation manual.
- (3) Ask a dealer or an authorized technician to install, relocate and repair the unit.
For appliances not accessible to the general public.
- (4) Refrigerant pipes connection shall be accessible for maintenance purposes.
- (5) If the air conditioner is installed in a small room or closed room, measures must be taken to prevent the refrigerant concentration in the room from exceeding the safety limit in the event of refrigerant leakage. Should the refrigerant leak and cause the concentration limit to be exceeded, hazards due to lack of oxygen in the room may result.
- (6) Keep gas-burning appliances, electric heaters, and other fire sources (ignition sources) away from the location where installation, repair, and other air conditioner work will be performed.
If refrigerant comes into contact with a flame, poisonous gases will be released.
- (7) When installing or relocating, or servicing the air conditioner, use only the specified refrigerant (R32) to charge the refrigerant lines.
Do not mix it with any other refrigerant and do not allow air to remain in the lines.
If air is mixed with the refrigerant, then it can be the cause of abnormal high pressure in the refrigerant line, and may result in an explosion and other hazards.
- (8) After installation has been completed, check for refrigerant leaks. If refrigerant leaks into the room and comes into contact with the flame of a heater or portable cooking range, poisonous gases will be released.
- (9) Do not use low temperature solder alloy in case of brazing the refrigerant pipes.
- (10) When performing brazing work, be sure to ventilate the room sufficiently. Make sure that there are no hazardous or flammable materials nearby.
When performing the work in a closed room, small room, or similar location, make sure that there are no refrigerant leaks before performing the work.
If refrigerant leaks and accumulates, it may ignite or poisonous gases may be released.
- (11) Do not install the unit in places where refrigerant may build-up or places with poor ventilation such as a semi-basement or a sunken place in outdoor: Refrigerant is heavier than air, and inclined to fall away from the leak source.
- (12) Do not use means to accelerate the defrosting process or to clean, other than those recommended by the manufacturer.
- (13) The appliance shall be stored in a room without continuously operating ignition sources (for example: open flames, an operating gas appliance or an operating electric heater).
- (14) Do not pierce or burn.
- (15) Be aware that refrigerants may not contain an odour.
- (16) Pipe-work shall be protected from physical damage.
- (17) The installation of pipe-work shall be kept to a minimum.
- (18) Compliance with national gas regulations shall be observed.
- (19) Keep any required ventilation openings clear of obstruction.
- (20) Servicing shall be performed only as recommended by the manufacturer.
- (21) The appliance shall be stored in a well-ventilated area where the room size corresponds to the room area as specified for operation.
- (22) Maintenance, service and repair operations shall be performed by authorized technician with required qualification.
- (23) Be sure to have appropriate ventilation in order to prevent ignition. Furthermore, be sure to carry out fire prevention measures that there are no dangerous or flammable objects in the surrounding area.

[2] Cautions for service

- (1) Perform service after recovering the refrigerant left in unit completely.
- (2) Do not release refrigerant in the air.
- (3) After completing service, charge the cycle with specified amount of refrigerant.
- (4) When performing service, install a filter drier simultaneously.
Be sure to use a filter drier for new refrigerant.

[3] Additional refrigerant charge

When charging directly from cylinder

R32 is a single refrigerant and its composition does not change. Therefore, both liquid charging and gas charging are possible. Liquid charging of refrigerant all at once from the low-pressure side may cause the compressor malfunction. Accordingly, make sure that charging is gradual.

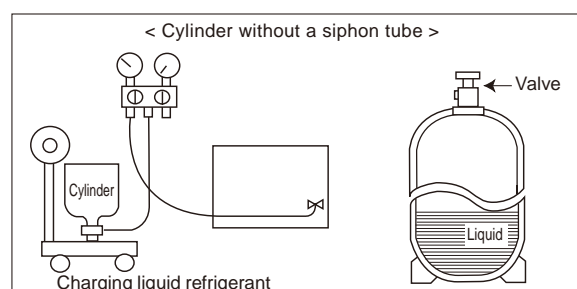
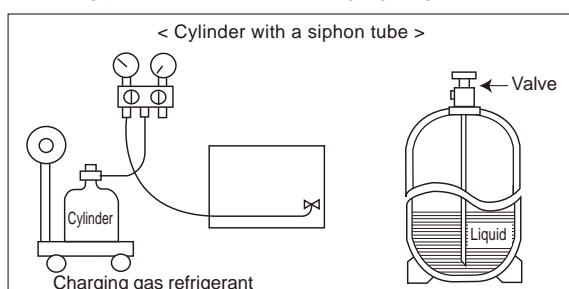

[4] Cautions for unit using R32 refrigerant

Basic work procedures are the same as those for conventional units using refrigerant R410A. However, pay careful attention to the following points.

(1) Information on servicing

(1-1) Checks on the Area

Prior to beginning work on systems containing flammable refrigerants, safety checks are necessary to ensure that the risk of ignition is minimized.

For repair to the refrigerating systems, (1-3) to (1-7) shall be completed prior to conducting work on the systems.

(1-2) Work Procedure

Work shall be undertaken under a controlled procedure so as to minimize the risk of a flammable gas or vapor being present while the work is being performed.

(1-3) General Work Area

All maintenance staff and others working in the local area shall be instructed on the nature of work being carried out.

Work in confined spaces shall be avoided. The area around the workspace shall be sectioned off. Ensure that the conditions within the area have been made safe by control of flammable material.

(1-4) Checking for Presence of Refrigerant

The area shall be checked with an appropriate refrigerant detector prior to and during work, to ensure the technician is aware of potentially toxic or flammable atmospheres. Ensure that the leak detection equipment being used is suitable for use with all applicable refrigerants, i.e. non-sparking, adequately sealed or intrinsically safe.

(1-5) Presence of Fire Extinguisher

If any hot work is to be conducted on the refrigeration equipment or any associated parts, appropriate fire extinguishing equipment shall be available to hand.

Have a dry powder or CO2 fire extinguisher adjacent to the charging area.

(1-6) No Ignition Sources

No person carrying out work in relation to a refrigeration system which involves exposing any pipe work shall use any sources of ignition in such a manner that it may lead to the risk of fire or explosion. All possible ignition sources, including cigarette smoking, should be kept sufficiently far away from the site of installation, repairing, removing and disposal, during which refrigerant can possibly be released to the surrounding space. Prior to work taking place, the area around the equipment is to be surveyed to make sure that there are no flammable hazards or ignition risks. "No Smoking" signs shall be displayed.

(1-7) Ventilated Area

Ensure that the area is in the open or that it is adequately ventilated before breaking into the system or conducting any hot work. A degree of ventilation shall continue during the period that the work is carried out. The ventilation should safely disperse any released refrigerant and preferably expel it externally into the atmosphere.

(1-8) Checks on the Refrigeration Equipment

Where electrical components are being changed, they shall be fit for the purpose and to the correct specification. At all times the manufacturer's maintenance and service guidelines shall be followed. If in doubt, consult the manufacturer's technical department for assistance.

The following checks shall be applied to installations using flammable refrigerants:

- The charge size is in accordance with the room size within which the refrigerant containing parts are installed.
- The ventilation machinery and outlets are operating adequately and are not obstructed.
- Marking to the equipment continues to be visible and legible. Markings and signs that are illegible shall be corrected.
- Refrigeration pipe or components are installed in a position where they are unlikely to be exposed to any substance which may corrode refrigerant containing components, unless the components are constructed of materials which are inherently resistant to being corroded or are suitably protected against being corroded.

(1-9) Checks on Electrical Devices

Repair and maintenance to electrical components shall include initial safety checks and component inspection procedures. If a fault exists that could compromise safety, then no electrical supply shall be connected to the circuit until it is satisfactorily dealt with. If the fault cannot be corrected immediately but it is necessary to continue operation, an adequate temporary solution shall be used. This shall be reported to the owner of the equipment so all parties are advised. Initial safety checks shall include that:

- capacitors are discharged: this shall be done in a safe manner to avoid possibility of sparking;
- no live electrical components and wiring are exposed while charging, recovering or purging the system;
- there is continuity of earth bonding

(2) Repairs to Sealed Components

(2-1) During repairs to sealed components, all electrical supplies shall be disconnected from the equipment being worked upon prior to any removal of sealed covers, etc. If it is absolutely necessary to have an electrical supply to equipment during servicing, then a permanently operating form of leak detection shall be located at the most critical point to warn of a potentially hazardous situation.

(2-2) Particular attention shall be paid to the following to ensure that by working on electrical components, the casing is not altered in such a way that the level of protection is affected. This shall include damage to cables, excessive number of connections, terminals not made to original specification, damage to seals, incorrect fitting of glands, etc.

Ensure that the apparatus is mounted securely.

Ensure that seals or sealing materials have not degraded to the point that they no longer serve the purpose of preventing the ingress of flammable atmospheres.

Replacement parts shall be in accordance with the manufacturer's specifications.

(3) Repair to intrinsically Safe Components

Do not apply any permanent inductive or capacitance loads to the circuit without ensuring that this will not exceed the permissible voltage and current permitted for the equipment in use.

Intrinsically safe components are the only types that can be worked on while live in the presence of a flammable atmosphere. The test apparatus shall be at the correct rating.

Replace components only with parts specified by the manufacturer. Other parts may result in the ignition of refrigerant in the atmosphere from a leak.

(4) Cabling

Check that cabling will not be subject to wear, corrosion, excessive pressure, vibration, sharp edges or any other adverse environmental effects. The check shall also take into account the effects of aging or continual vibration from sources such as compressors or fans.

(5) Detection of Flammable Refrigerants

Under no circumstances shall potential sources of ignition be used in the searching for or detection of refrigerant leaks.

A halide torch (or any other detector using a naked flame) shall not be used.

(6) Leak Detection Methods

Electronic leak detectors may be used to detect refrigerant leaks but, in the case of flammable refrigerants, the sensitivity may not be adequate, or may need re-calibration. (Detection equipment shall be calibrated in a refrigerant-free area.)

Ensure that the detector is not a potential source of ignition and is suitable for the refrigerant used. Leak detection equipment shall be set at a percentage of the LFL of the refrigerant and shall be calibrated to the refrigerant employed, and the appropriate percentage of gas (25% maximum) is confirmed.

Leak detection fluids are suitable for use with most refrigerants but the use of detergents containing chlorine shall be avoided as the chlorine may react with the refrigerant and corrode the copper pipe-work.

If a leak is suspected, all naked flames shall be removed/extinguished.

If a leakage of refrigerant is found which requires brazing, all of the refrigerant shall be recovered from the system, or isolated (by means of shut off valves) in a part of the system remote from the leak. For appliances containing flammable refrigerants, oxygen free nitrogen (OFN) shall then be purged through the system both before and during the brazing process.

(7) Removal and Evacuation

When breaking into the refrigerant circuit to make repairs – or for any other purpose conventional procedures shall be used. However, for flammable refrigerants it is important that best practice is followed since flammability is a consideration. The following procedure shall be adhered to:

- remove refrigerant
- purge the circuit with inert gas
- evacuate
- purge again with inert gas
- open the circuit by cutting or brazing.

The refrigerant charge shall be recovered into the correct recovery cylinders. For appliances containing flammable refrigerants, the system shall be “flushed” with OFN to render the unit safe. This process may need to be repeated several times.

Compressed air or oxygen shall not be used for purging refrigerant systems.

For appliances containing flammable refrigerants, flushing shall be achieved by breaking the vacuum in the system with OFN and continuing to fill until the working pressure is achieved, then venting to atmosphere, and finally pulling down to a vacuum. This process shall be repeated until no refrigerant is within the system. When the final OFN charge is used, the system shall be vented down to atmospheric pressure to enable work to take place. This operation is absolutely vital if brazing operations on the pipe-work are to take place.

Ensure that the outlet for the vacuum pump is not close to any ignition sources and that ventilation is available.

(8) Charging Procedures

In addition to conventional charging procedures, the following requirements shall be followed:

- Ensure that contamination of different refrigerants does not occur when using charging equipment. Hoses or lines shall be as short as possible to minimize the amount of refrigerant contained in them.
- Cylinders shall be kept upright.
- Ensure that the refrigeration system is earthed prior to charging the system with refrigerant.
- Label the system when charging is complete (if not already).
- Extreme care shall be taken not to overfill the refrigeration system.

Prior to recharging the system, it shall be pressure-tested with the appropriate purging gas. The system shall be leak-tested on completion of charging but prior to commissioning. A follow up leak test shall be carried out prior to leaving the site.

(9) Decommissioning

Before carrying out this procedure, it is essential that the technician is completely familiar with the equipment and all its detail. It is recommended good practice that all refrigerants are recovered safely. Prior to the task being carried out, an oil and refrigerant sample shall be taken in case analysis is required prior to re-use of reclaimed refrigerant. It is essential that electrical power is available before the task is commenced.

- a) Become familiar with the equipment and its operation.

- b) Isolate system electrically.
- c) Before attempting the procedure, ensure that:
 - mechanical handling equipment is available, if required, for handling refrigerant cylinders;
 - all personal protective equipment is available and being used correctly;
 - the recovery process is supervised at all times by a competent person;
 - recovery equipment and cylinders conform to the appropriate standards.
- d) Pump down refrigerant system, if possible.
- e) If a vacuum is not possible, make a manifold so that refrigerant can be removed from various parts of the system.
- f) Make sure that cylinder is situated on the scales before recovery takes place.
- g) Start the recovery machine and operate in accordance with manufacturer's instructions.
- h) Do not overfill cylinders. (No more than 80 % volume liquid charge).
- i) Do not exceed the maximum working pressure of the cylinder, even temporarily.
- j) When the cylinders have been filled correctly and the process completed, make sure that the cylinders and the equipment are removed from site promptly and all isolation valves on the equipment are closed off.
- k) Recovered refrigerant shall not be charged into another refrigeration system unless it has been cleaned and checked.

(10) Labelling

Equipment shall be labelled stating that it has been de-commissioned and emptied of refrigerant. The label shall be dated and signed. For appliances containing flammable refrigerants, ensure that there are labels on the equipment stating the equipment contains flammable refrigerant.

(11) Recovery

When removing refrigerant from a system, either for servicing or decommissioning, it is recommended good practice that all refrigerants are removed safely. When transferring refrigerant into cylinders, ensure that only appropriate refrigerant recovery cylinders are employed. Ensure that the correct number of cylinders for holding the total system charge are available. All cylinders to be used are designated for the recovered refrigerant and labelled for that refrigerant (i.e. special cylinders for the recovery of refrigerant). Cylinders shall be complete with pressure-relief valve and associated shut-off valves in good working order. Empty recovery cylinders are evacuated and, if possible, cooled before recovery occurs.

The recovery equipment shall be in good working order with a set of instructions concerning the equipment that is at hand and shall be suitable for the recovery of all appropriate refrigerants including, when applicable, flammable refrigerants. In addition, a set of calibrated weighing scales shall be available and in good working order. Hoses shall be complete with leak-free disconnect couplings and in good condition. Before using the recovery machine, check that it is in satisfactory working order, has been properly maintained and that any associated electrical components are sealed to prevent ignition in the event of a refrigerant release. Consult manufacturer if in doubt.

The recovered refrigerant shall be returned to the refrigerant supplier in the correct recovery cylinder, and the relevant waste transfer note arranged. Do not mix refrigerants in recovery units and especially not in cylinders. If compressors or compressor oils are to be removed, ensure that they have been evacuated to an acceptable level to make certain that flammable refrigerant does not remain within the lubricant. The evacuation process shall be carried out prior to returning the compressor to the suppliers. Only electric heating to the compressor body shall be employed to accelerate this process. When oil is drained from a system, it shall be carried out safely.

[5] Service tools

Use the below service tools as exclusive tools for R32 refrigerant.

No.	Tool name	Specifications
①	Gauge manifold	<ul style="list-style-type: none"> · Only for R32 · Use the existing fitting specifications. (UNF1/2) · Use high-tension side pressure of 5.3MPa·G or over.
②	Charge hose	<ul style="list-style-type: none"> · Only for R32 · Use pressure performance of 5.09MPa·G or over.
③	Electronic scale	—
④	Gas leak detector	· Use the detector for R134a, R407C, R410a or R32.
⑤	Adaptor for reverse flow check	· Attach on vacuum pump.
⑥	Refrigerant charge base	—
⑦	Refrigerant cylinder	<ul style="list-style-type: none"> · Only for R32 · Cylinder with syphon
⑧	Refrigerant recovery equipment	—

2-3. PRECAUTIONS WHEN REUSING EXISTING R22/R410a REFRIGERANT PIPES

(1) Flowchart

- Refer to the flowchart below to determine if the existing pipes can be used and if it is necessary to use a filter dryer.
- If the diameter of the existing pipes is different from the specified diameter, refer to technical data materials to confirm if the pipes can be used.

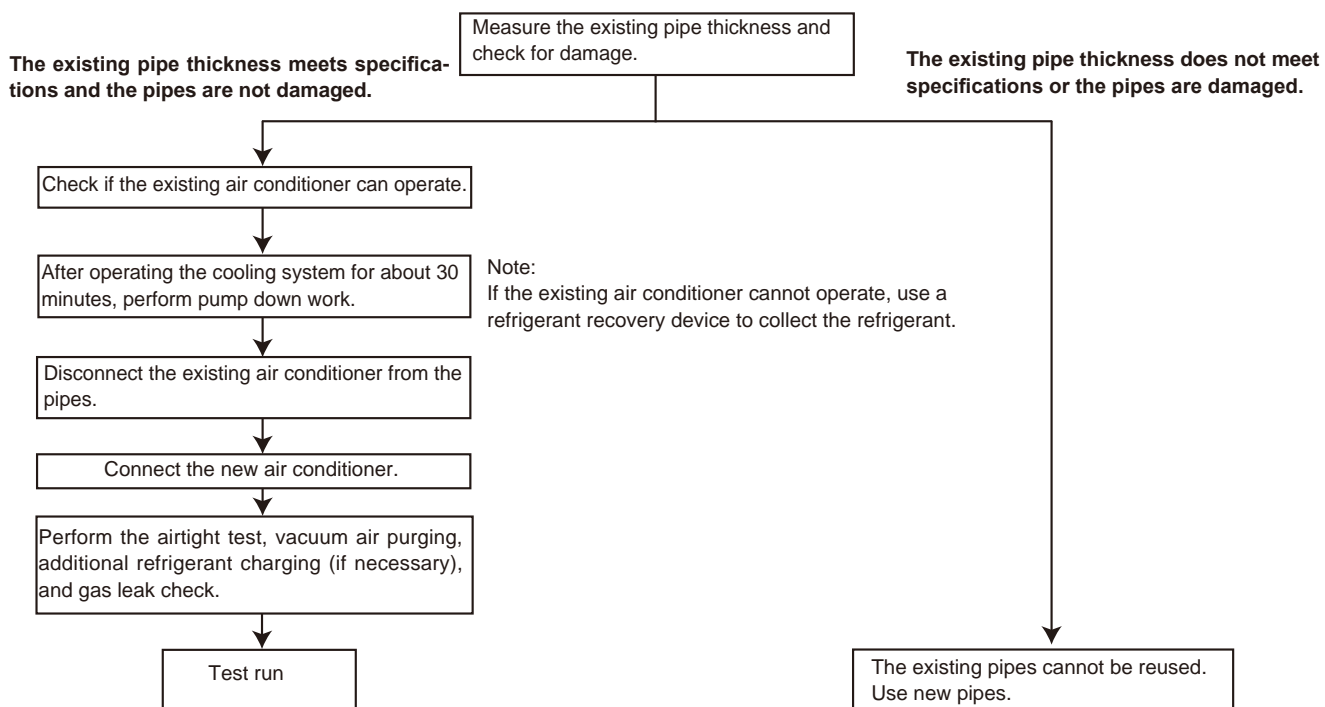

(2) Cautions for refrigerant piping work

New refrigerant R32 is adopted for replacement inverter series. Although the refrigerant piping work for R32 is same as for R22, exclusive tools are necessary so as not to mix with different kind of refrigerant. Furthermore as the working pressure of R32 is 1.6 times higher than that of R22, their sizes of flared sections and flare nuts are different.

① Thickness of pipes

Because the working pressure of R32 is higher compared to R22, be sure to use refrigerant piping with thickness shown below. (Never use pipes of 0.7 mm or below.)

Diagram below: Piping diameter and thickness

Nominal dimensions(inch)	Outside diameter (mm)	Thickness (mm)	
		R32/R410a	R22
1/4	6.35	0.8	0.8
3/8	9.52	0.8	0.8
1/2	12.70	0.8	0.8
5/8	15.88	1.0	1.0
3/4	19.05	—	1.0

② Dimensions of flare cutting and flare nut

The component molecules in HFC refrigerant are smaller compared to conventional refrigerants. In addition to that, R32 is a refrigerant, which has higher risk of leakage because its working pressure is higher than that of other refrigerants. Therefore, to enhance airtightness and strength, flare cutting dimension of copper pipe for R32 has been specified separately from the dimensions for other refrigerants as shown below. The dimension B of flare nut for R32 also has partly been changed to increase strength as shown below. Set copper pipe correctly referring to copper pipe flaring dimensions for R32 below. For 1/2 and 5/8 inch pipes, the dimension B changes. Use torque wrench corresponding to each dimension.

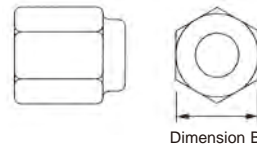
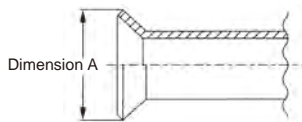

Flare cutting dimensions

Nominal dimensions(inch)	Outside diameter(mm)	Dimension A (+0.4 / -0.4) (mm)	
		R32/R410a	R22
1/4	6.35	9.1	9.0
3/8	9.52	13.2	13.0
1/2	12.70	16.6	16.2
5/8	15.88	19.7	19.4
3/4	19.05	—	23.3

Flare nut dimensions

Nominal dimensions(inch)	Outside diameter(mm)	Dimension B (mm)	
		R32/R410a	R22
1/4	6.35	17.0	17.0
3/8	9.52	22.0	22.0
1/2	12.70	26.0	24.0
5/8	15.88	29.0 *	27.0
3/4	19.05	—	36.0

* 36.0mm for indoor unit of RP100, 125 and 140

③ Tools for R32 (The following table shows whether conventional tools can be used or not.)

Tools and materials	Use	R32 tools	Can R22 tools be used?	Can R407C tools be used?	Can R410a tools be used?
Gauge manifold	Air purge, refrigerant charge and operation check	Tool exclusive for R32	×	×	○
Charge hose		Tool exclusive for R32	×	×	○
Gas leak detector	Gas leak check	Tool for HFC refrigerant	×	○	○
Refrigerant recovery equipment	Refrigerant recovery	Tool exclusive for R32	×	×	○
Refrigerant cylinder	Refrigerant charge	Tool exclusive for R32	×	×	×
Safety charger	Prevent compressor malfunction when charging refrigerant by spraying liquid refrigerant	Tool exclusive for R32	×	×	○
Charge valve	Prevent gas from blowing out when detaching charge hose	Tool exclusive for R32	×	×	○
Vacuum pump	Vacuum drying and air purge	Tools for other refrigerants can be used if equipped with adapter for reverse flow check	△(Usable if equipped with adapter for reverse flow)	△(Usable if equipped with adapter for reverse flow)	△(Usable if equipped with adapter for reverse flow)
Flare tool	Flaring work of piping	Tools for other refrigerants can be used by adjusting flaring dimension	△(Usable by adjusting flaring dimension)	△(Usable by adjusting flaring dimension)	△(Usable by adjusting flaring dimension)
Bender	Bend the pipes	Tools for other refrigerants can be used	○	○	○
Pipe cutter	Cut the pipes	Tools for other refrigerants can be used	○	○	○
Welder and nitrogen gas cylinder	Weld the pipes	Tools for other refrigerants can be used	○	○	○
Refrigerant charging scale	Refrigerant charge	Tools for other refrigerants can be used	○	○	○
Vacuum gauge or thermistor vacuum gauge and vacuum valve	Check the degree of vacuum. (Vacuum valve prevents back flow of oil and refrigerant to thermistor vacuum gauge)	Tools for other refrigerants can be used	○	○	○
Charging cylinder	Refrigerant charge	Tool exclusive for R32	×	—	×

× : Prepare a new tool. (Use the new tool as the tool exclusive for R32.)

△ : Tools for other refrigerants can be used under certain conditions.

○ : Tools for other refrigerants can be used.

2-4. CHOOSING THE OUTDOOR UNIT INSTALLATION LOCATION

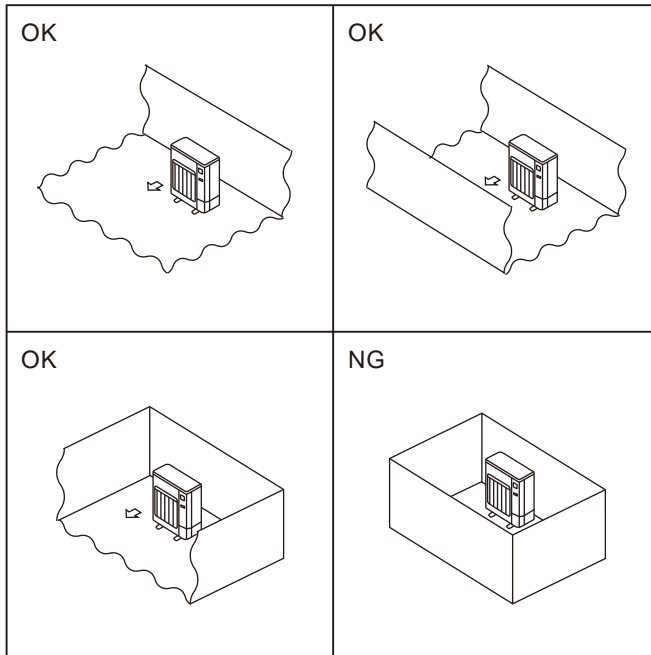

R32 is heavier than air—as well as other refrigerants—so tends to accumulate at the base (in the vicinity of the floor). If R32 accumulates around base, it may reach a flammable concentration in case room is small. To avoid ignition, maintaining a safe work environment is required by ensuring appropriate ventilation. If a refrigerant leak is confirmed in a room or an area where there is insufficient ventilation, refrain from using of flames until the work environment can be improved by ensuring appropriate ventilation.

Install outdoor units in a place where at least one of the four sides is open, and in a sufficiently large space without depressions.

2-5. MINIMUM INSTALLATION AREA

If you unavoidably install a unit in a space where all four sides are blocked or there are depressions, confirm that one of these situations (A, B or C) is satisfied.

Note: These countermeasures are for keeping safety not for specification guaranteee.

A) Secure sufficient installation space (minimum installation area A_{min}).

Install in a space with an installation area of A_{min} or more, corresponding to refrigerant quantity M (factory-charged refrigerant + locally added refrigerant).

M [kg]	A_{min} [m ²]
1.0	12
1.5	17
2.0	23
2.5	28
3.0	34
3.5	39
4.0	45
4.5	50
5.0	56
5.5	62
6.0	67
6.5	73
7.0	78
7.5	84

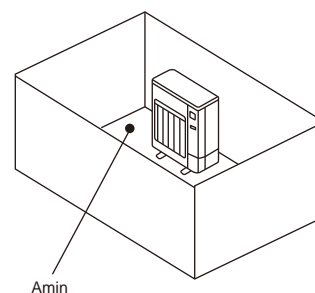

B) Install in a space with a depression height of 0.125 [m] or less.

Height from the bottom of
0.125 [m] or less

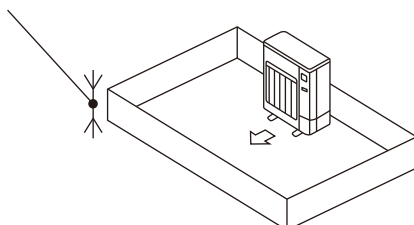

Height from the bottom of
0.125 [m] or less

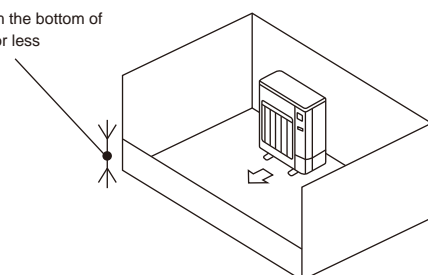

C) Create an appropriate ventilation open area.

Make sure that the width of the open area is 0.9 [m] or more and the height of the open area is 0.15 [m] or more. However, the height from the bottom of the installation space to the bottom edge of the open area should be 0.125 [m] or less. Open area should be 75% or more opening.

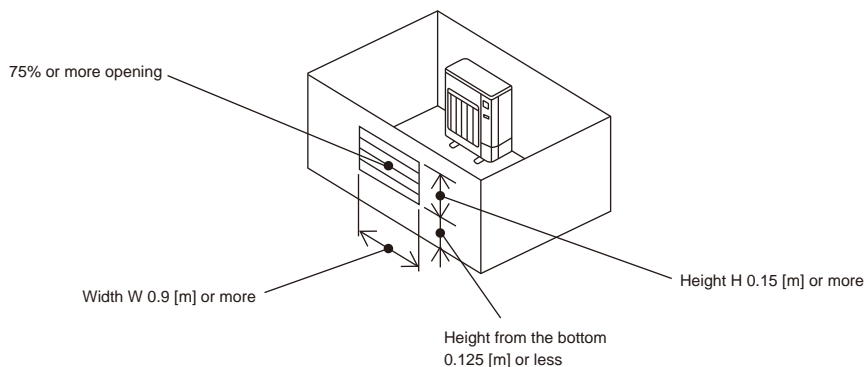

■ Indoor units

Install in a room with a floor area of A_{min} or more, corresponding to refrigerant quantity M (factory-charged refrigerant + locally added refrigerant).

* For the factory-charged refrigerant amount, refer to the spec nameplate or installation manual.

For the amount to be added locally, refer to the installation manual.

Install the indoor unit so that the height from the floor to the bottom of the indoor unit is h_0 ;

for wall mounted: 1.8 m or more;

for ceiling suspended, cassette and ceiling concealed: 2.2 m or more.

* There are restrictions in installation height for each model, so read the installation manual for the particular unit.

M [kg]	A_{min} [m ²]
1.0	3
1.5	4.5
2.0	6
2.5	7.5
3.0	9
3.5	12
4.0	15.5
4.5	20
5.0	24
5.5	29
6.0	35
6.5	41
7.0	47
7.5	54

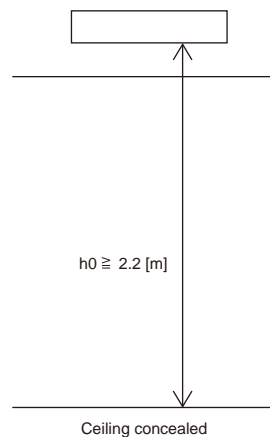
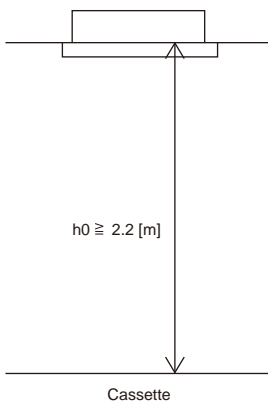
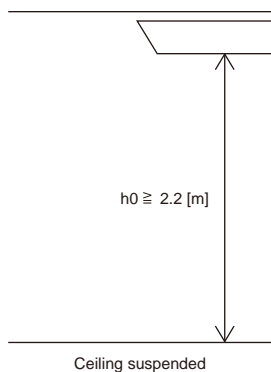
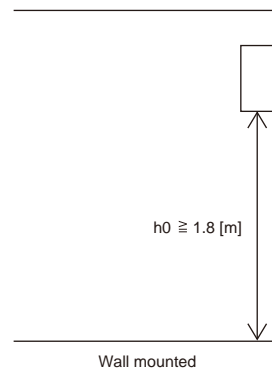

3

PART NAMES AND FUNCTIONS

MXZ-2HA40VF
MXZ-2HA50VF

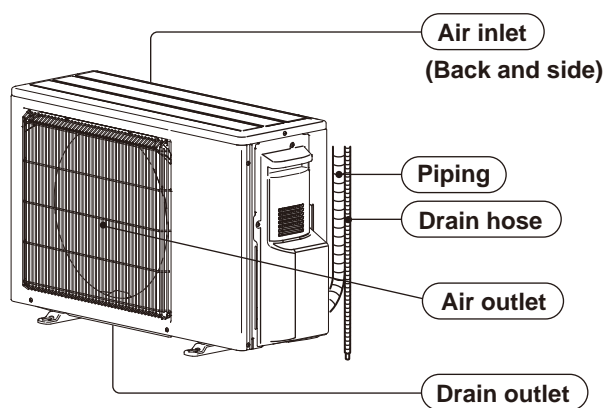

MXZ-3HA50VF

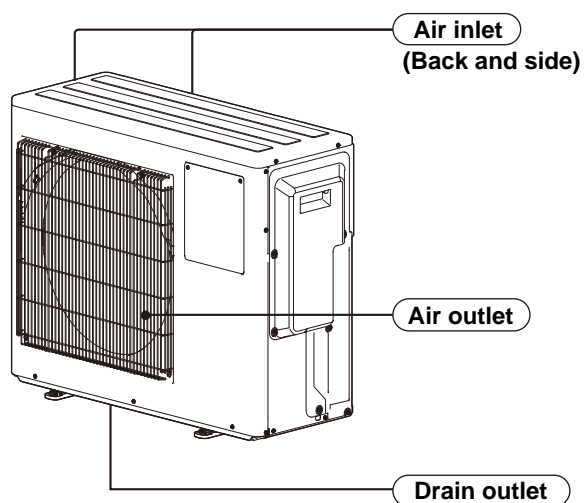

ACCESSORIES

Model	MXZ-2HA40VF MXZ-2HA50VF	MXZ-3HA50VF
① Drain socket	1	1
② Drain cap	-	2

4

SPECIFICATION

Outdoor model			MXZ-2HA40VF		
Outdoor unit power supply			Single phase 220 - 230 - 240 V, 50 Hz		
System	Indoor units number		2		
	Piping total length	m	Max. 30		
	Connecting pipe length	m	Max. 20		
	Height difference (Indoor ~ Outdoor)	m	Refer to 8 REFRIGERANT SYSTEM DIAGRAM.		
	Height difference (Indoor ~ Indoor)	m	Refer to 8 REFRIGERANT SYSTEM DIAGRAM.		
Function			Cooling	Heating	
Capacity Rated (Min.-Max.) *2		kW	4.0 (1.1 - 4.3)	4.3 (1.0 - 4.7)	
Breaker capacity		A	15		
Electrical data	Power input (Total) *1, *2		W	1,050	910
	Running current (Total) *1, *2		A	5.1 - 4.9 - 4.7 (220V - 230V - 240V)	4.8 - 4.6 - 4.4 (220V - 230V - 240V)
	Power factor (Total) *1, *2		%	94	87
	Starting current (Total) *1, *2		A	7.6	
Coefficient of performance (C.O.P) (Total) *1, *2			3.81	4.73	
Compressor	Model		SVB130FBBMT		
	Output	W	1,100		
	Current *1, *2	A	4.15		
	Refrigeration oil (Model)	L	0.35 (FW68S)		
Fan motor	Model		RC0J50-NA		
	Current *1, *2	A	0.35		
Dimensions W x H x D		mm	800 x 550 x 285		
Weight		kg	37		
Special remarks	Air flow (Rated)	m ³ /h	1,704	2,010	
	Sound level (Rated)	dB(A)	44	50	
	Fan speed (Rated)	rpm	780	910	
	Pre-charged refrigerant quantity (R32)	kg	0.9		
	Max refrigerant quantity (R32)	kg	0.9		

*1 Measured under rated operating frequency.

*2 When connected with indoor units below.

MSZ-HR25VF + MSZ-HR25VF

NOTE: Test conditions are based on ISO 5151. (Refrigerant piping length (one way): 5 m)

COOLING INDOOR Dry-bulb temperature 27.0 °C Wet-bulb temperature 19.0 °C

OUTDOOR Dry-bulb temperature 35.0 °C Wet-bulb temperature 24.0 °C

HEATING INDOOR Dry-bulb temperature 20.0 °C

OUTDOOR Dry-bulb temperature 7.0 °C Wet-bulb temperature 6.0 °C



Outdoor model			MXZ-2HA50VF		
Outdoor unit power supply			Single phase 220 - 230 - 240 V, 50 Hz		
System	Indoor units number		2		
	Piping total length	m	Max. 30		
	Connecting pipe length	m	Max. 20		
	Height difference (Indoor ~ Outdoor)	m	Refer to 8 REFRIGERANT SYSTEM DIAGRAM.		
	Height difference (Indoor ~ Indoor)	m	Refer to 8 REFRIGERANT SYSTEM DIAGRAM.		
Function			Cooling	Heating	
Capacity Rated (Min.-Max.) *2		kW	5.0 (1.1 - 5.4)	6.0 (1.0 - 6.4)	
Breaker capacity		A	15		
Electrical data	Power input (Total) *1, *2		W	1,520	1,540
	Running current (Total) *1, *2		A	7.1 - 6.8 - 6.5 (220V - 230V - 240V)	7.2 - 6.9 - 6.6 (220V - 230V - 240V)
	Power factor (Total) *1, *2		%	97	
	Starting current (Total) *1, *2		A	7.6	
Coefficient of performance (C.O.P) (Total) *1, *2			3.29	3.90	
Compressor	Model		SVB130FBBMT		
	Output	W	1,300		
	Current *1, *2	A	6.75		
	Refrigeration oil (Model)	L	0.35 (FW68S)		
Fan motor	Model		RC0J50-NA		
	Current *1, *2	A	0.35		
Dimensions W x H x D		mm	800 x 550 x 285		
Weight		kg	37		
Special remarks	Air flow (Rated)	m ³ /h	1,962	2,082	
	Sound level (Rated)	dB(A)	47	51	
	Fan speed (Rated)	rpm	890	940	
	Pre-charged refrigerant quantity (R32)	kg	0.9		
	Max refrigerant quantity (R32)	kg	0.9		

*1 Measured under rated operating frequency.

*2 When connected with indoor units below.

MSZ-HR25VF + MSZ-HR25VF

NOTE: Test conditions are based on ISO 5151. (Refrigerant piping length (one way): 5 m)

COOLING INDOOR Dry-bulb temperature 27.0 °C Wet-bulb temperature 19.0 °C

OUTDOOR Dry-bulb temperature 35.0 °C Wet-bulb temperature 24.0 °C

HEATING INDOOR Dry-bulb temperature 20.0 °C

OUTDOOR Dry-bulb temperature 7.0 °C Wet-bulb temperature 6.0 °C



Outdoor model			MXZ-3HA50VF		
Outdoor unit power supply			Single phase 220 - 230 - 240 V, 50 Hz		
System	Indoor units number		2 to 3		
	Piping total length	m	Max. 50		
	Connecting pipe length	m	Max. 25		
	Height difference (Indoor ~ Outdoor)	m	Refer to 8 REFRIGERANT SYSTEM DIAGRAM.		
	Height difference (Indoor ~ Indoor)	m	Refer to 8 REFRIGERANT SYSTEM DIAGRAM.		
Function			Cooling	Heating	
Capacity Rated (Min.-Max.) *2		kW	5.0 (2.9 - 6.5)	6.0 (2.6 - 7.5)	
Breaker capacity		A	25		
Electrical data	Power input (Total) *1, *2		W	1,260	1,300
	Running current (Total) *1, *2		A	5.9 - 5.6 - 5.4 (220V - 230V - 240V)	6.1 - 5.8 - 5.6 (220V - 230V - 240V)
	Power factor (Total) *1, *2		%	97	
	Starting current (Total) *1, *2		A	6.7	
Coefficient of performance (C.O.P) (Total) *1, *2			3.97	4.62	
Compressor	Model		SVB130FBBM1T		
	Output	W	1,300		
	Current *1, *2	A	5.30		
	Refrigeration oil (Model)	L	0.6 (FW68S)		
Fan motor	Model		SIC-82FX-F764-1		
	Current *1, *2	A	0.5		
Dimensions W x H x D		mm	840 x 710 x 330		
Weight		kg	57		
Special remarks	Air flow (Rated)	m ³ /h	1,860	1,746	
	Sound level (Rated)	dB(A)	46	50	
	Fan speed (Rated)	rpm	600	580	
	Pre-charged refrigerant quantity (R32)	kg	1.4		
	Max refrigerant quantity (R32)	kg	1.6		

*1 Measured under rated operating frequency.

*2 When connected with indoor units below.

MSZ-HR25VF + MSZ-HR25VF + MSZ-HR25VF

NOTE: Test conditions are based on ISO 5151. (Refrigerant piping length (one way): 5 m)

COOLING INDOOR Dry-bulb temperature 27.0 °C Wet-bulb temperature 19.0 °C

OUTDOOR Dry-bulb temperature 35.0 °C Wet-bulb temperature 24.0 °C

HEATING INDOOR Dry-bulb temperature 20.0 °C

OUTDOOR Dry-bulb temperature 7.0 °C Wet-bulb temperature 6.0 °C

5

NOISE CRITERIA CURVES

MXZ-2HA40VF

FAN SPEED	FUNCTION	SPL(dB(A))	LINE
High	Cooling	44	●—●
High	Heating	50	○—○

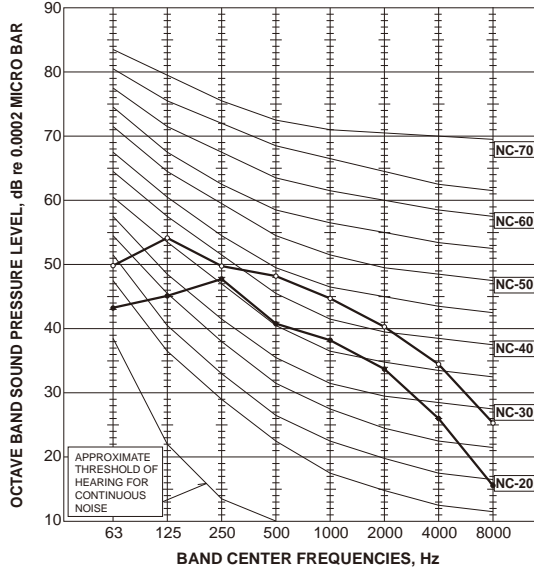

MXZ-2HA50VF

FAN SPEED	FUNCTION	SPL(dB(A))	LINE
High	Cooling	47	●—●
High	Heating	51	○—○

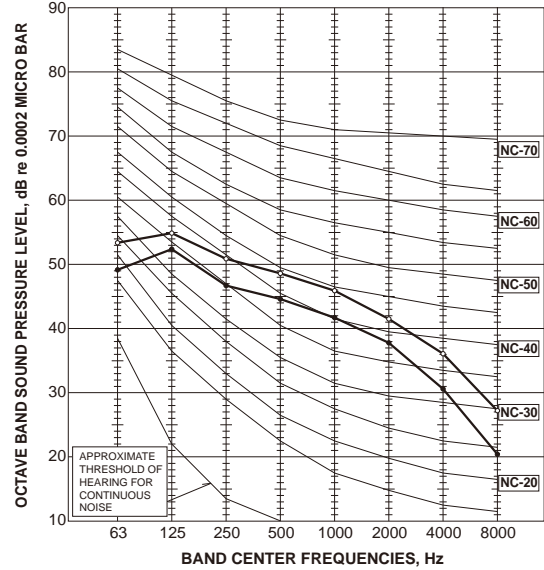

MXZ-3HA50VF

FAN SPEED	FUNCTION	SPL(dB(A))	LINE
High	Cooling	46	●—●
High	Heating	50	○—○

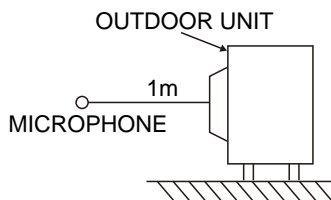
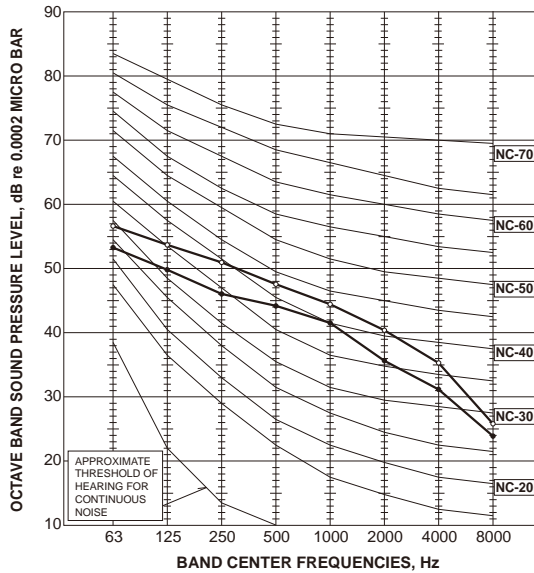

Test conditions

Cooling :Dry-bulb temperature 35.0°C Wet-bulb temperature 24.0°C
 Heating :Dry-bulb temperature 7.0°C Wet-bulb temperature 6.0°C

MXZ-2HA40VF MXZ-2HA50VF

Unit: mm (inch)

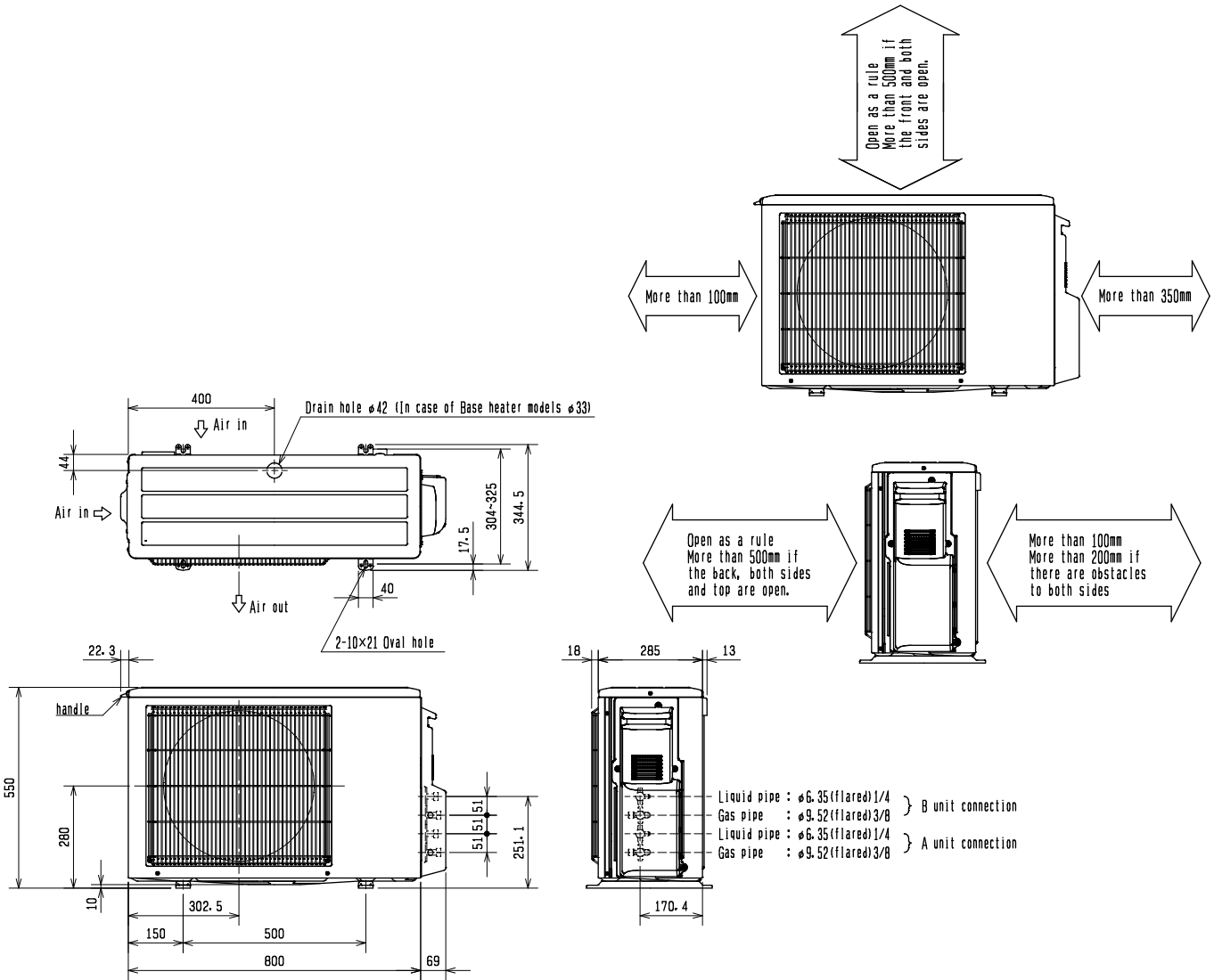

MXZ-3HA50VF

Unit: mm (inch)

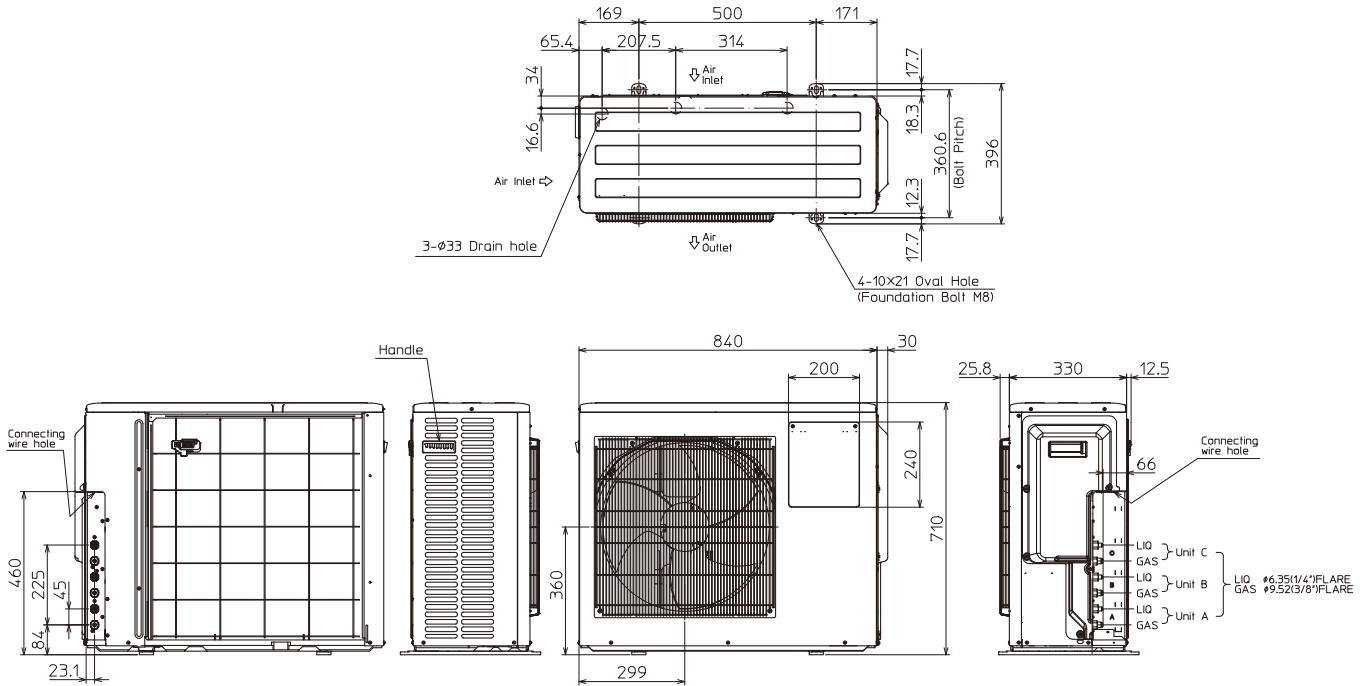

1. Installation space

Note : Leave front and both sides free of obstruction.

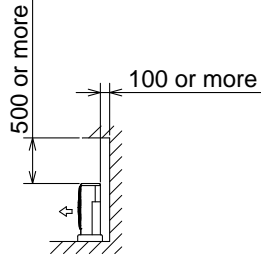

2. Service space

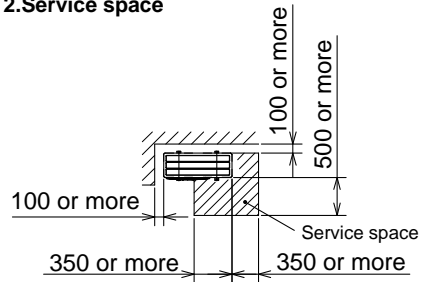

Note : Leave front and overhead free of obstruction.

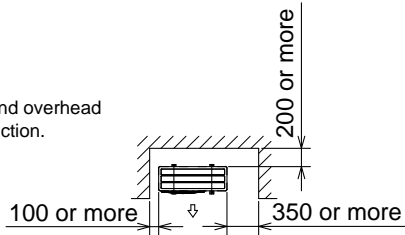

Note : Leave rear, overhead and both sides free of obstruction.

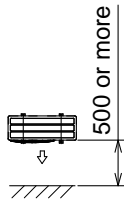

MXZ-2HA40VF -[E1] MXZ-2HA50VF -[E1] MXZ-2HA40VF -[E2] MXZ-2HA50VF -[E2]

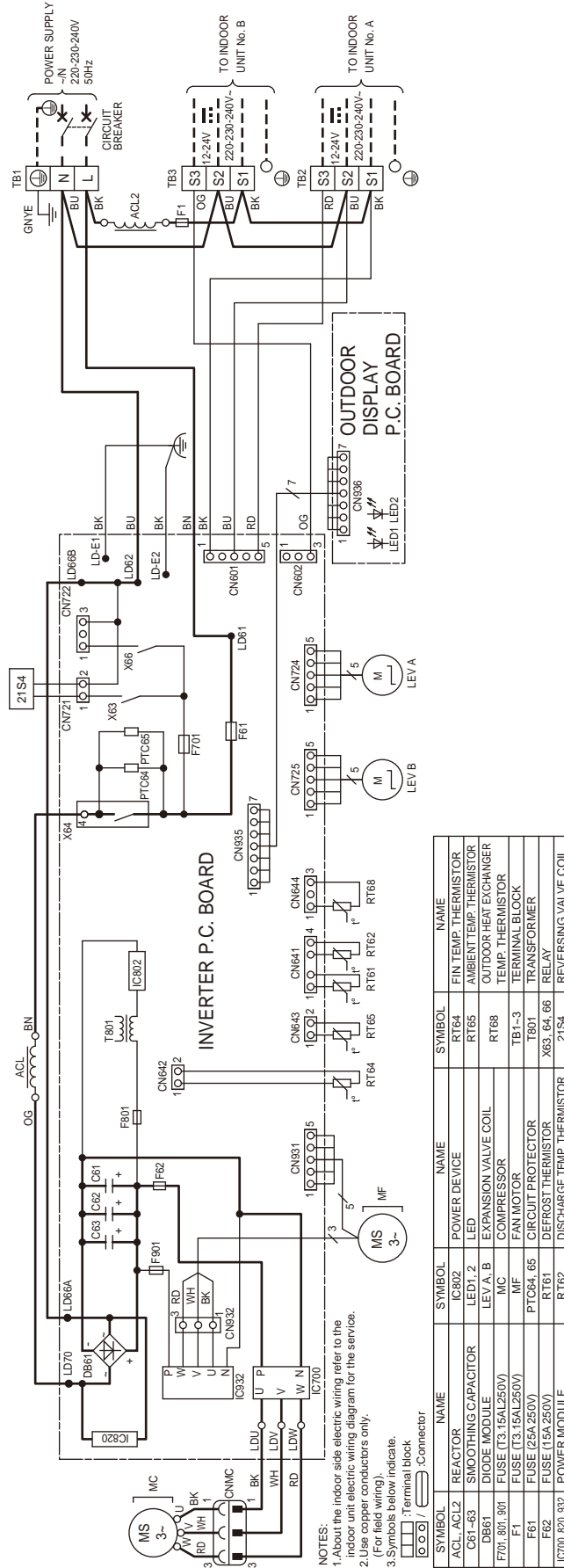

SYMBOL	NAME	SYMBOL	NAME	SYMBOL	NAME
IC802	REACTOR	IC802	POWER DEVICE	RT64	FIN TEMP. THERMISTOR
ACL2	ACL2	LED1.2	LED	RT65	AMBIENT TEMP. THERMISTOR
CR1-43	SMOOTHING CAPACITOR	LEV A, B	EXPANSION VALVE COIL	RT68	OUTDOOR HEAT EXCHANGER TEMP. THERMISTOR
DB61	DIODE MODULE	MC	COMPRESSOR	TB1-3	TERMINAL BLOCK
F701, 801, 901	FUSE (T3, 15AL/250V)	PTC64, 65	FAN MOTOR	T601	TRANSFORMER
F61	FUSE (25A/250V)	RT61	CIRCUIT PROTECTOR	X63, 64, 66	RELAY
F62	FUSE (15A/250V)	RT62	DEFROST THERMISTOR	Z1S4	REVERSING VALVE COIL
IC701, 820, 932	POWER MODULE		DISCHARGE TEMP. THERMISTOR		

MXZ-2HA40VF - [ET1] MXZ-2HA50VF - [ET1]

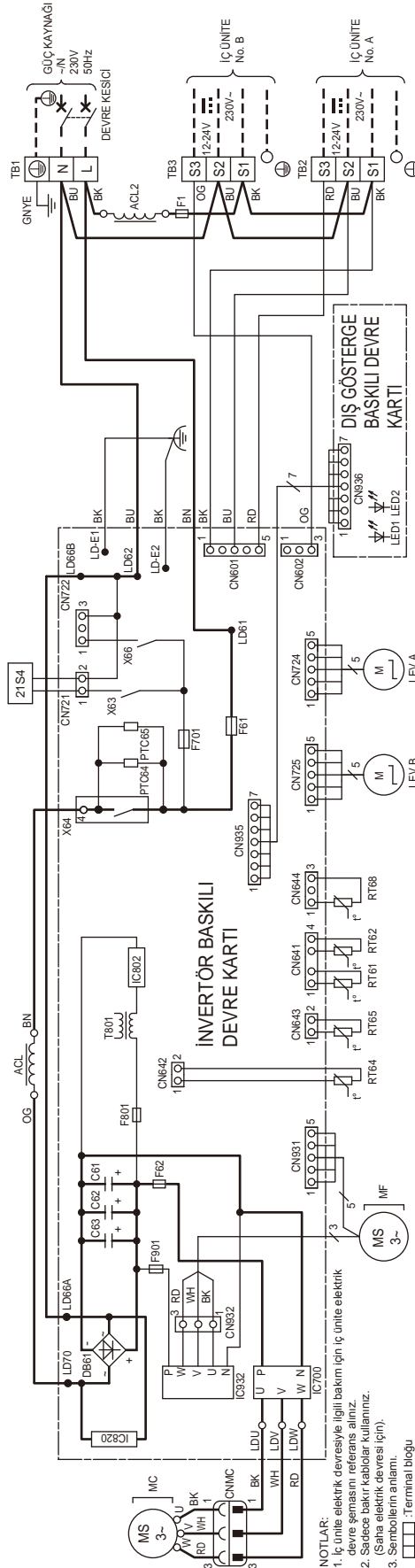

NOTLAR:
 1. İÇ ünite elektrik devresiyle ilgili bakım için iç ünite elektrik devre şemasını referans alınınız.
 2. Sadece bakır kablolar kullanınız.
 3. Sembollerin anlamı:
 ○ ○ ○ ○ / : Terminal bloğu
 ○ ○ ○ ○ / : Konnektör

SEMBOLE	PARÇA ADI	SEMBOLE	PARÇA ADI
ACL2	REAKTÖR	IC802	GUÇ CİHAZI
C81-83	SUZME KAPASİTÖR	LED1, 2	LED
DB81	DIYOT MODÜLÜ	LEV. A, B	GENLEŞME VANASI SARGISI
F701, 801, 901	SİGORTA (T3.15A/250V)	MC	KOMPRESÖR
F1	SİGORTA (T3.15A/250V)	MF	FAN MOTORU
F81	SİGORTA (25A/250V)	PTC64, 65	DEVRE KORUMASI
F82	SİGORTA (15A/250V)	RT81	DEFROST TERMİSTÖRÜ
IC700, 820, 932	GUÇ MODÜLÜ	RT82	BASMA SICAKLIK TERMİSTÖRÜ
		RT84	FIN SICAKLIK TERMİSTÖRÜ
		RT85	ORJANSICAKLIK TERMİSTÖRÜ
		RT88	DIŞ UNİTE ESANJÖR SICAKLIK TERMİSTÖRÜ
		TB1-3	TERMINAL BLOĞU
		T801	TRANSFORMATÖR
		X63, 64, 66	ROLE
		Z1S4	İKİ YÖNLÜ VANA SARGISI

MXZ-3HA50VF - E1 MXZ-3HA50VF - E2

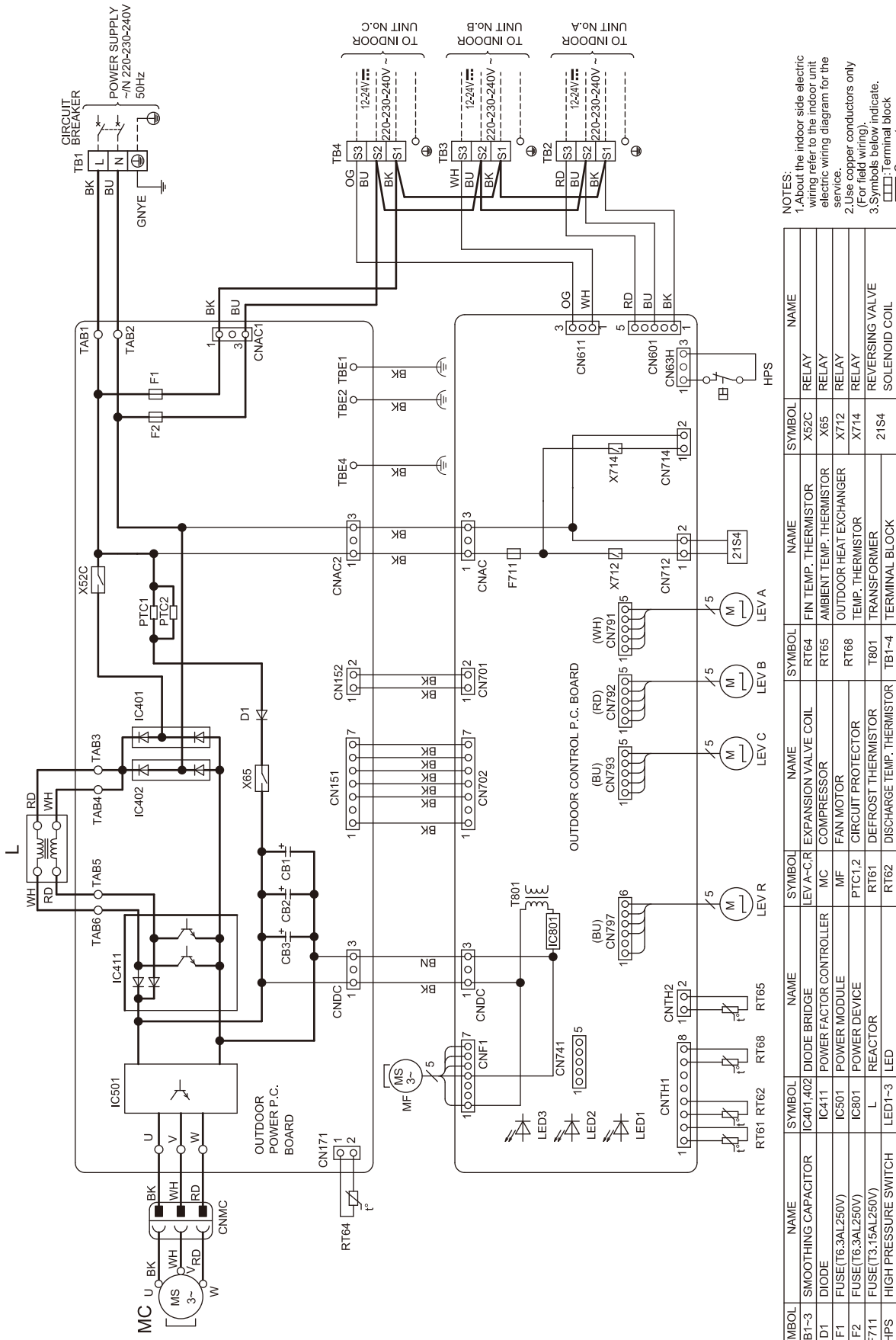

NOTES:
 1. About the indoor side electric wiring, refer to the indoor unit electric wiring diagram for the service.
 2. Use copper conductors only (For field wiring).
 3. Symbols below indicate.
 □: Terminal block
 ○: Connector

SYMBOL	NAME	SYMBOL	NAME	SYMBOL	NAME	SYMBOL	NAME
CB1-3	SMOOTHING CAPACITOR	IC401.402	DIODE BRIDGE	LEV A-C/R	EXPANSION VALVE COIL	RT64	FIN TEMP. THERMISTOR
D1	DIODE	IC501	POWER FACTOR CONTROLLER	MC	COMPRESSOR	RT65	AMBIENT TEMP. THERMISTOR
F1	FUSE(T6.3AL250V)	IC411	POWER MODULE	MF	FAN MOTOR	RT68	OUTDOOR HEAT EXCHANGER
F2	FUSE(T6.3AL250V)	IC301	POWER DEVICE	PTC1.2	CIRCUIT PROTECTOR	T801	TEMP. THERMISTOR
F711	FUSE(T3.15AL250V)	L	REACTOR	RT61	DEFROST THERMISTOR	T801	TRANSFORMER
HPS	HIGH PRESSURE SWITCH	LED1-3	LED	RT62	DISCHARGE TEMP. THERMISTOR	TB1-4	TERMINAL BLOCK
		LED1-3	LED	RT65	LEVA-C/R		SOLENOID COIL
		LED1-3	LED	RT66	LEV A		
		LED1-3	LED	RT67	LEV B		
		LED1-3	LED	RT68	LEV C		
		LED1-3	LED	RT69	LEV R		
		LED1-3	LED	RT70	LEV B		
		LED1-3	LED	RT71	LEV A		
		LED1-3	LED	RT72	LEV B		
		LED1-3	LED	RT73	LEV C		
		LED1-3	LED	RT74	LEV R		
		LED1-3	LED	RT75	LEV B		
		LED1-3	LED	RT76	LEV A		
		LED1-3	LED	RT77	LEV B		
		LED1-3	LED	RT78	LEV C		
		LED1-3	LED	RT79	LEV R		
		LED1-3	LED	RT80	LEV B		
		LED1-3	LED	RT81	LEV A		
		LED1-3	LED	RT82	LEV B		
		LED1-3	LED	RT83	LEV C		
		LED1-3	LED	RT84	LEV R		
		LED1-3	LED	RT85	LEV B		
		LED1-3	LED	RT86	LEV A		
		LED1-3	LED	RT87	LEV B		
		LED1-3	LED	RT88	LEV C		
		LED1-3	LED	RT89	LEV R		
		LED1-3	LED	RT90	LEV B		
		LED1-3	LED	RT91	LEV A		
		LED1-3	LED	RT92	LEV B		
		LED1-3	LED	RT93	LEV C		
		LED1-3	LED	RT94	LEV R		
		LED1-3	LED	RT95	LEV B		
		LED1-3	LED	RT96	LEV A		
		LED1-3	LED	RT97	LEV B		
		LED1-3	LED	RT98	LEV C		
		LED1-3	LED	RT99	LEV R		
		LED1-3	LED	RT100	LEV B		

MXZ-3HA50VF - ET1

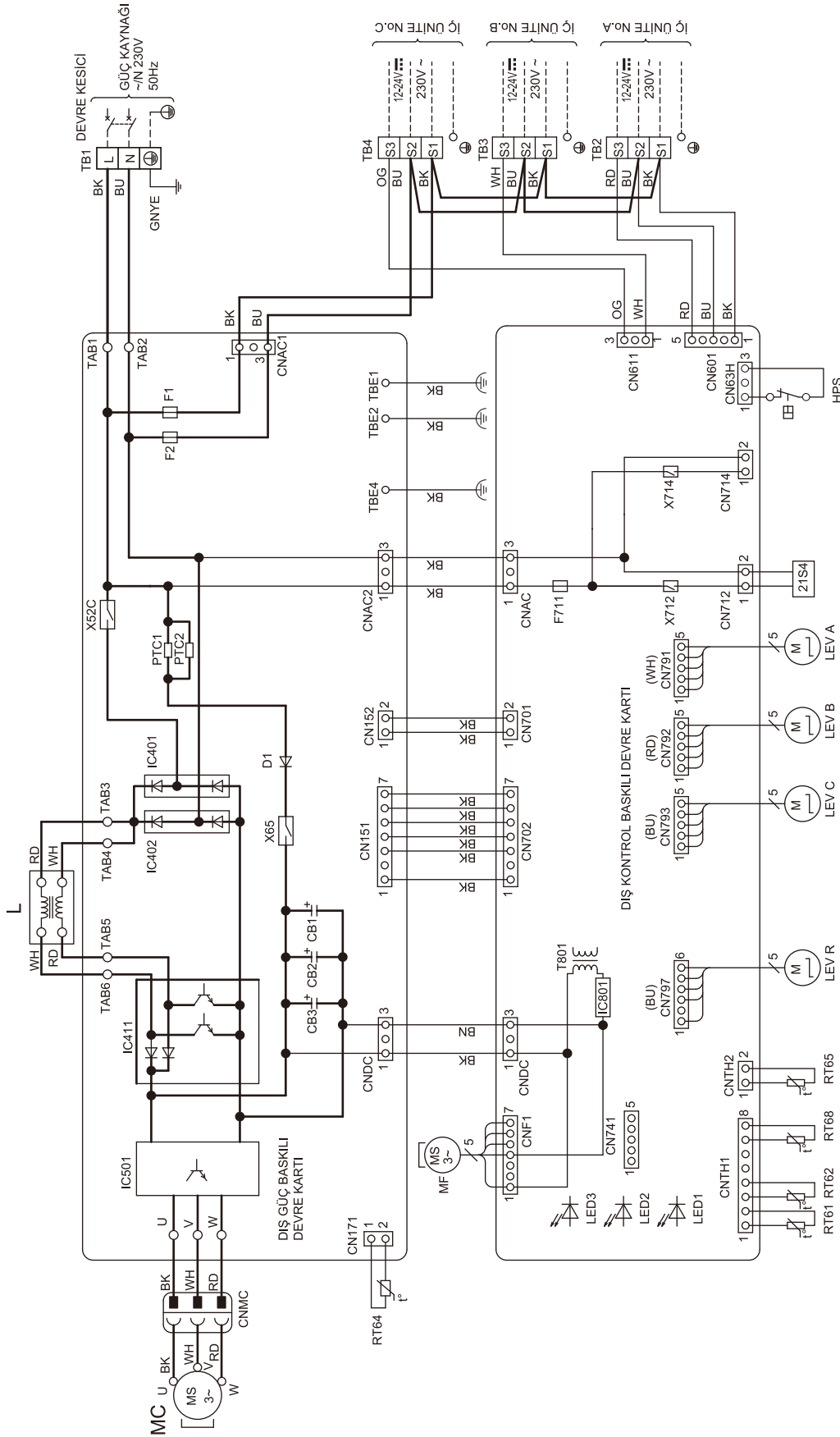

- NOTLAR:**
- İç ünite elektrik devresiyle ilgili bakım için iç ünite elektrik devre şemasını referans alınız.
 - Sadece bakır kablolar kullanın (Saha elektrik devresi için).
 - Sembollerin anlamı:
 : Terminal bloğu
 : Konnektör

SEMBOLE	PARÇA ADI	SEMBOLE	PARÇA ADI	SEMBOLE	PARÇA ADI
CB1-3	SÜZME KAPASİTÖR	RT64	FİN SICAKLIK TERMİSTÖRÜ	X52C	RÖLE
D1	DIYOT	RT65	ORTAM SICAKLIK TERMİSTÖRÜ	X65	RÖLE
F1	SİGORTA (T6.3AL250V)	RT68	DIŞ ÜNİTE EŞANJÖR	X712	RÖLE
F2	SİGORTA (T6.3AL250V)	PTC1,2	SICAKLIK TERMİSTÖRÜ	X714	RÖLE
F711	SİGORTA (T3.15AL250V)	RT80	TRANSFORMATÖR		
HPS	YÜKSEK BASINÇ SIVICI	RT62	BASMA SICAKLIK TERMİSTÖRÜ	21S4	SARGISI
			TERMINAL BLOĞU		

MXZ-2HA40VF MXZ-2HA50VF

UNIT: mm

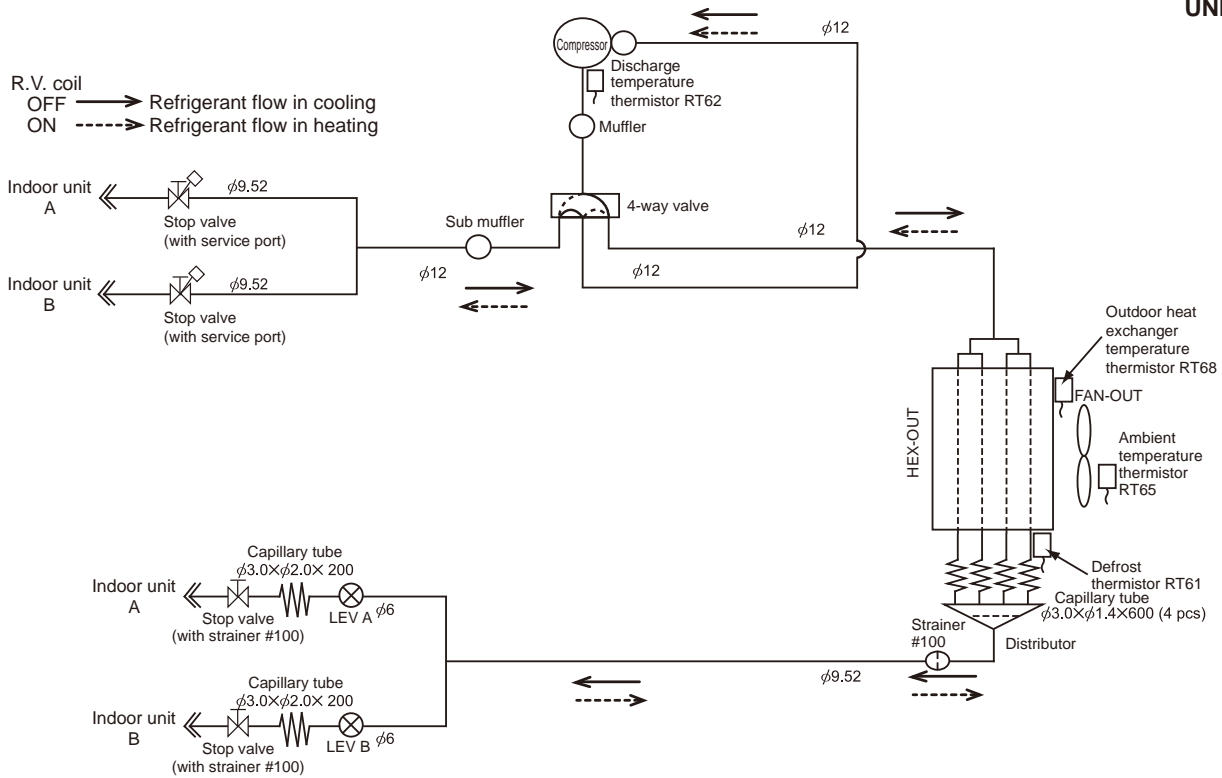

MAX REFRIGERANT PIPING LENGTH

Piping length each indoor unit (a, b)	20 m
Total piping length (a+b)	30 m
Bending point for each unit	30
Total bending point	20

*It is irrelevant which unit is higher.

ADDITIONAL REFRIGERANT CHARGE

Outdoor unit precharged (g)	Refrigerant piping length (one way, 2 unit total)
900	0

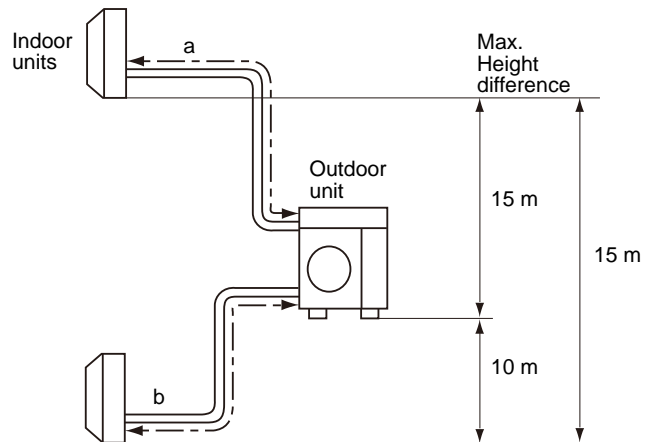

UNIT: mm (inch)

Outdoor unit union diameter		
For		
Indoor unit A	Liquid	6.35(1/4)
	Gas	9.52(3/8)
Indoor unit B	Liquid	6.35(1/4)
	Gas	9.52(3/8)

MXZ-3HA50VF

UNIT: mm

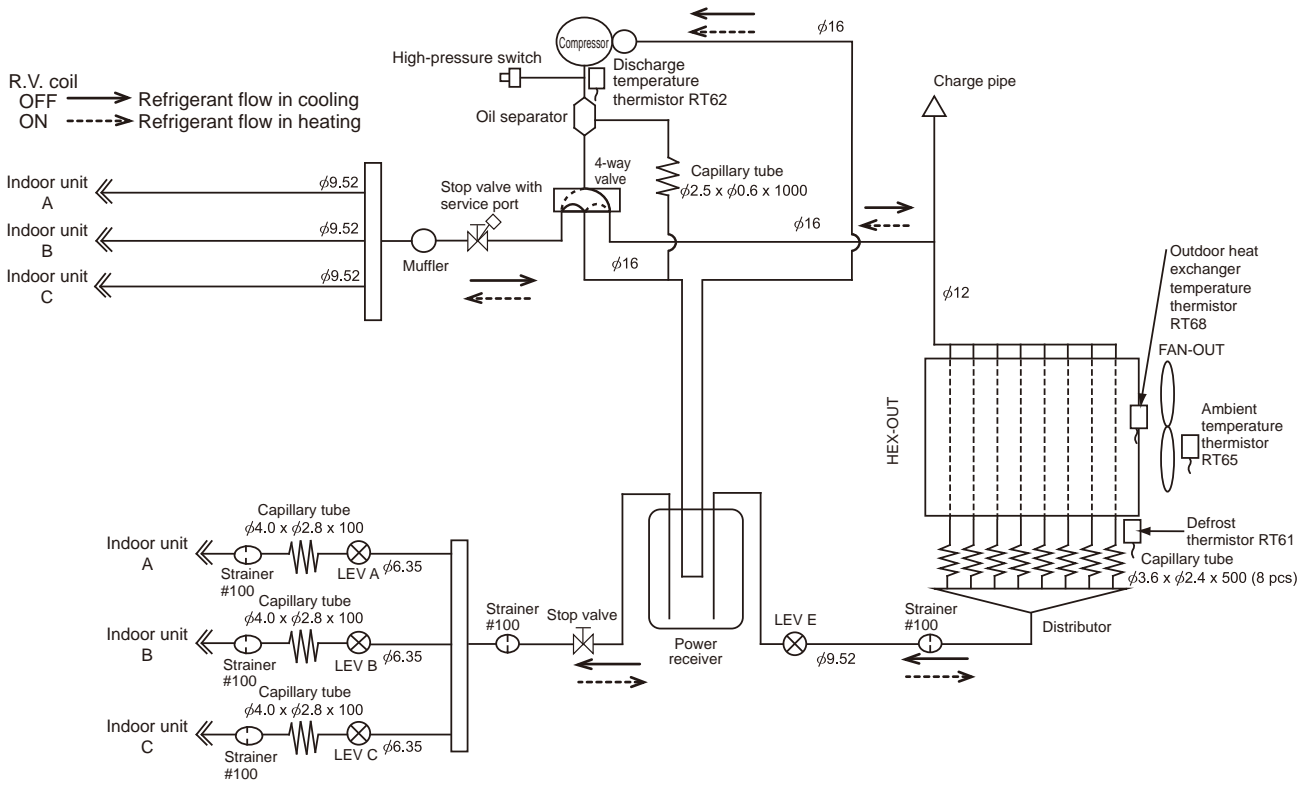

MAX REFRIGERANT PIPING LENGTH

Piping length each indoor unit (a, b, c)	25 m
Total piping length (a+b+c)	50 m
Bending point for each unit	25
Total bending point	50

*It is irrelevant which unit is higher.

ADDITIONAL REFRIGERANT CHARGE

Outdoor unit precharged (g)	Refrigerant piping length (one way, 3 unit total)	
	40 m	50 m
1,400	0	200

Calculation: $Xg = 20 \text{ g/m} \times (\text{Refrigerant piping length (m)} - 40)$

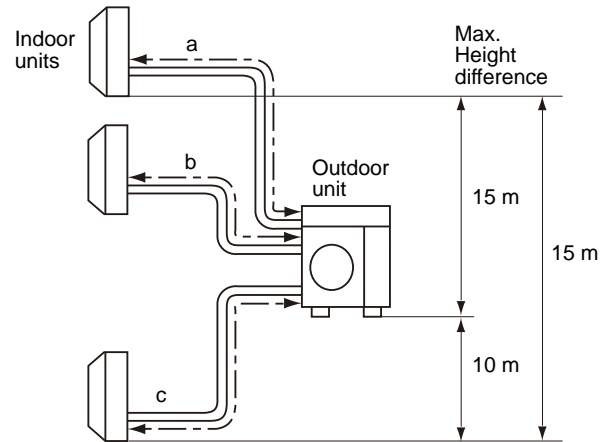

UNIT: mm (inch)

Outdoor unit union diameter		
For		
Indoor unit A	Liquid	6.35(1/4)
	Gas	9.52(3/8)
Indoor unit B	Liquid	6.35(1/4)
	Gas	9.52(3/8)
Indoor unit C	Liquid	6.35(1/4)
	Gas	9.52(3/8)

PUMPING DOWN

When relocating or disposing of the air conditioner, pump down the system following the procedure below so that no refrigerant is released into the atmosphere.

- 1) Turn off the breaker.
- 2) Connect the gauge manifold valve to the service port of the stop valve on the gas pipe side of the outdoor unit.
- 3) Fully close the stop valve on the liquid pipe side of the outdoor unit.
- 4) Turn on the breaker.
- 5) Start the emergency COOL operation on all the indoor units.
- 6) When the pressure gauge shows 0.05 to 0 MPa [Gauge] (approximately 0.5 to 0 kgf/cm²), fully close the stop valve on the gas pipe side of the outdoor unit and stop the operation. (Refer to the indoor unit installation manual about the method for stopping the operation.)
 - * If too much refrigerant has been added to the air conditioner system, the pressure may not drop to 0.05 to 0 MPa [Gauge] (approximately 0.5 to 0 kgf/cm²), or the protection function may operate due to the pressure increase in the high pressure refrigerant circuit. If this occurs, use a refrigerant collecting device to collect all of the refrigerant in the system, and then recharge the system with the correct amount of refrigerant after the indoor and outdoor units have been relocated.
- 7) Turn off the breaker. Remove the pressure gauge and the refrigerant piping.

WARNIG

When pumping down the refrigerant, stop the compressor before disconnecting the refrigerant pipes.
The compressor may burst and cause injury if any foreign substance, such as air, enters the pipes.

MXZ-2HA40VF MXZ-2HA50VF MXZ-3HA50VF

The standard specifications apply only to the operation of the air conditioner under normal conditions.

Since operating conditions vary according to the areas where these units are installed, the following information has been provided to clarify the operating characteristics of the air conditioner under the conditions indicated by the performance curve.

(1) GUARANTEED VOLTAGE

198 - 264 V 50 Hz

(2) AIR FLOW

Air flow should be set at MAX.

(3) MAIN READINGS

(1) Indoor intake air wet-bulb temperature:	°CWB	} Cooling
(2) Indoor outlet air wet-bulb temperature:	°CWB	
(3) Outdoor intake air dry-bulb temperature:	°CDB	
(4) Total input:	W	} Heating
(5) Indoor intake air dry-bulb temperature:	°CDB	
(6) Outdoor intake air wet-bulb temperature:	°CWB	
(7) Total input:	W	

Indoor air wet and dry bulb temperature difference on the left side of the following chart shows the difference between the indoor intake air wet and dry bulb temperature and the indoor outlet air wet and dry bulb temperature for your reference at service.

How to measure the indoor air wet and dry bulb temperature difference

1. Attach at least 2 sets of wet and dry bulb thermometers to the indoor air intake as shown in the figure, and at least 2 sets of wet and dry bulb thermometers to the indoor air outlet. The thermometers must be attached to the position where air speed is high.
2. Attach at least 2 sets of wet and dry bulb thermometers to the outdoor air intake. Cover the thermometers to prevent direct rays of the sun.
3. Check that the air filter is cleaned.
4. Open windows and doors of room.
5. Press the emergency operation switch once (twice) to start the EMERGENCY COOL (HEAT) MODE.
6. When system stabilizes after more than 15 minutes, measure temperature and take an average temperature.
7. 10 minutes later, measure temperature again and check that the temperature does not change.

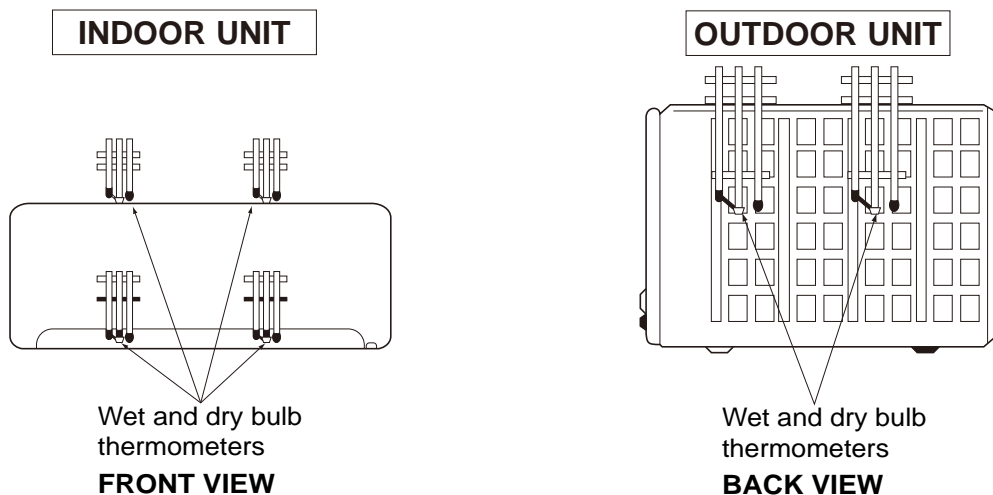

9-1. CAPACITY AND THE INPUT CURVES

MXZ-2HA40VF MXZ-2HA50VF

5.9	8.7	11.1
5.5	8.0	10.2
5.0	7.3	9.3
4.6	6.6	8.3
4.1	5.9	7.5
3.7	5.3	6.6
3.2	4.6	5.8
2.8	4.0	5.0
25 class		35 class
42 class (MXZ-2HA50VF)		

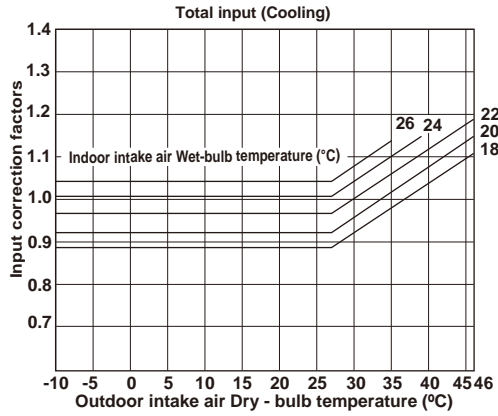
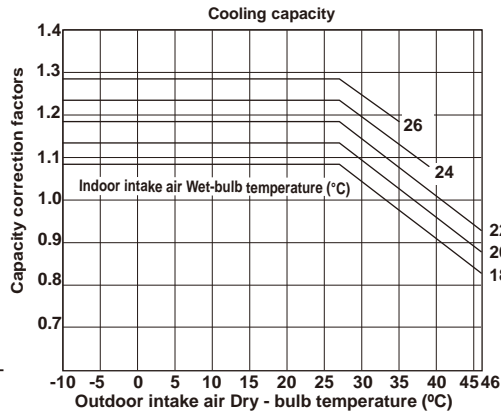

21.3	22.2	26.6
19.8	20.6	24.7
18.3	19.0	22.8
16.7	17.4	20.9
15.2	15.8	19.0
13.7	14.3	17.1
12.2	12.7	15.2
10.7	11.1	13.3
9.1	9.5	11.4
7.6	7.9	9.5
6.1	6.3	7.6
25 class		35 class
42 class (MXZ-2HA50VF)		

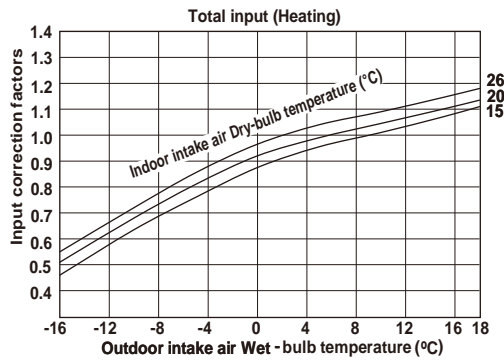
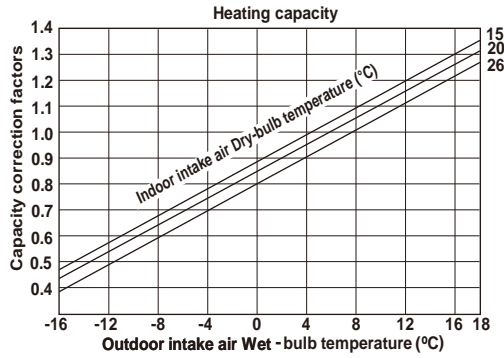

MXZ-3HA50VF

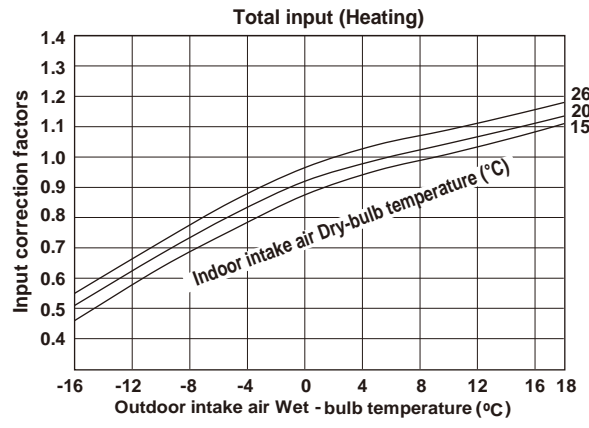
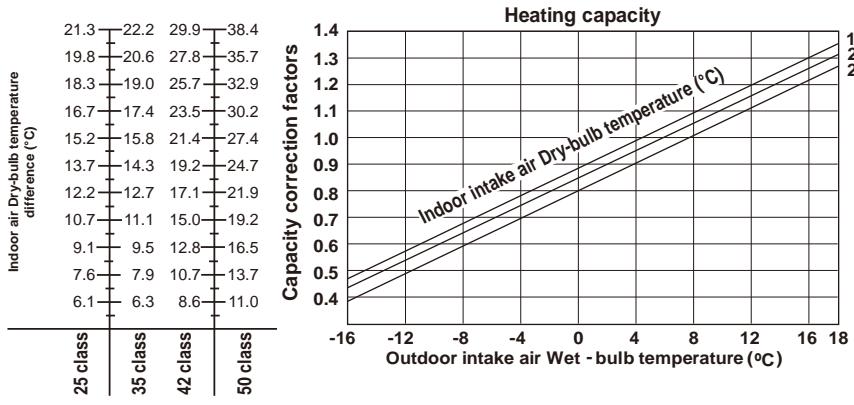
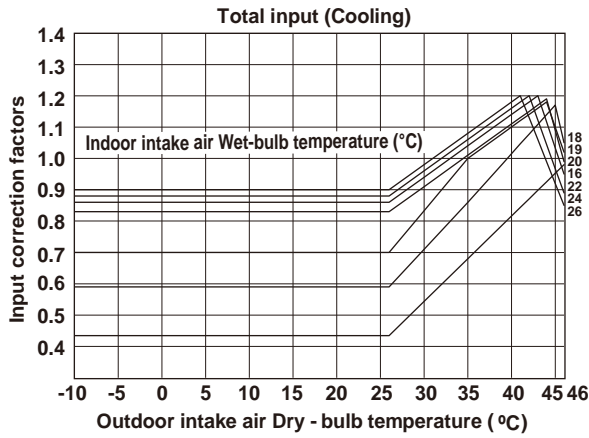
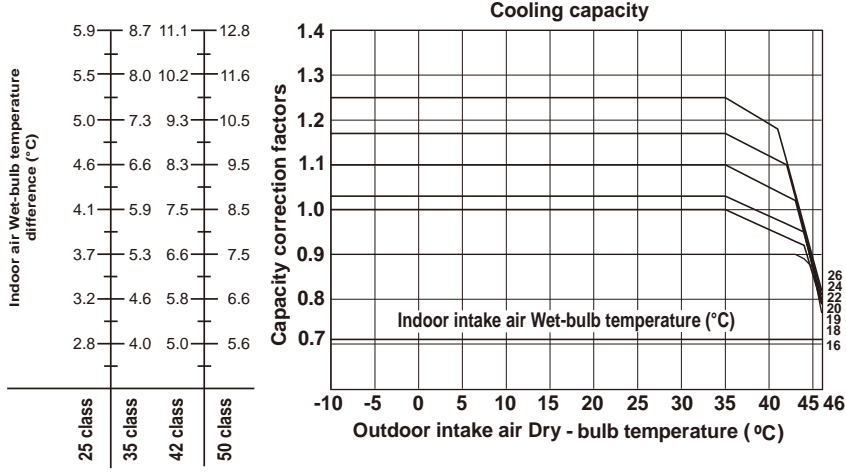

**9-2. CAPACITY AND INPUT CORRECTION BY INVERTER OUTPUT FREQUENCY (single operation)
MXZ-2HA40VF**

25-class unit

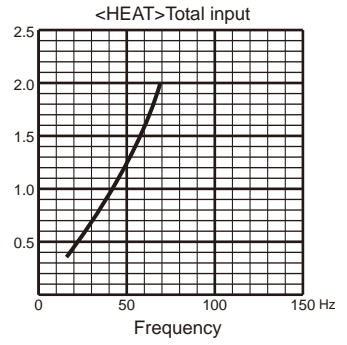
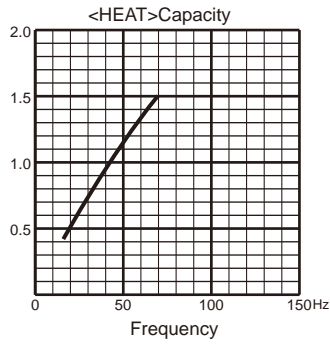
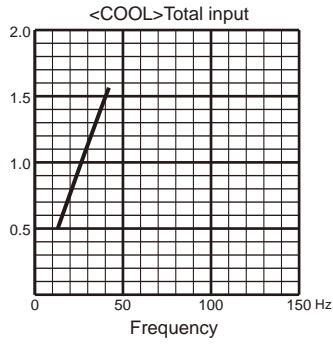
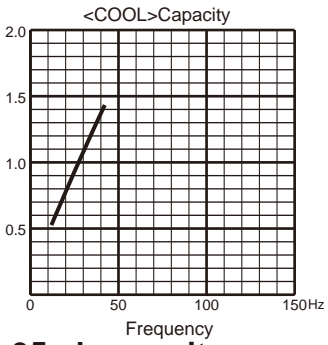

35-class unit

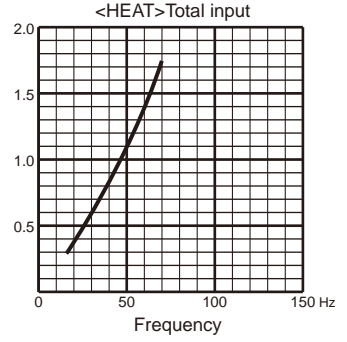
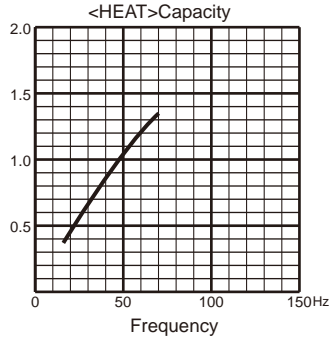
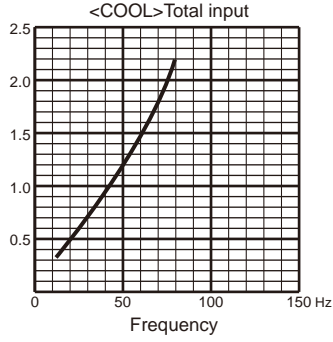
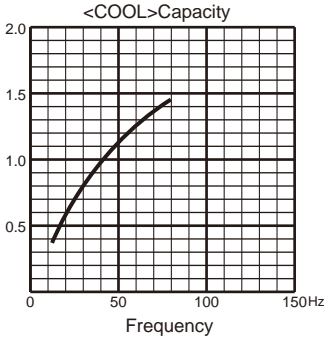

MXZ-2HA50VF

25-class unit

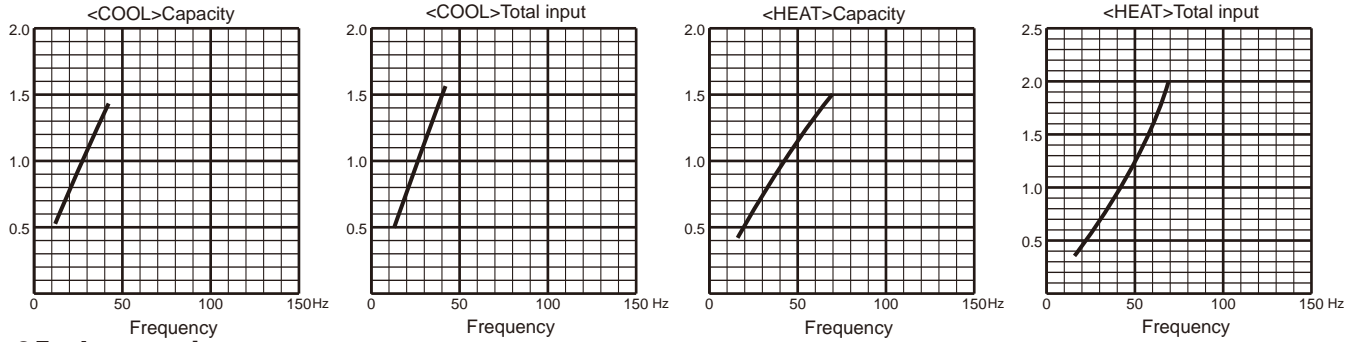

35-class unit

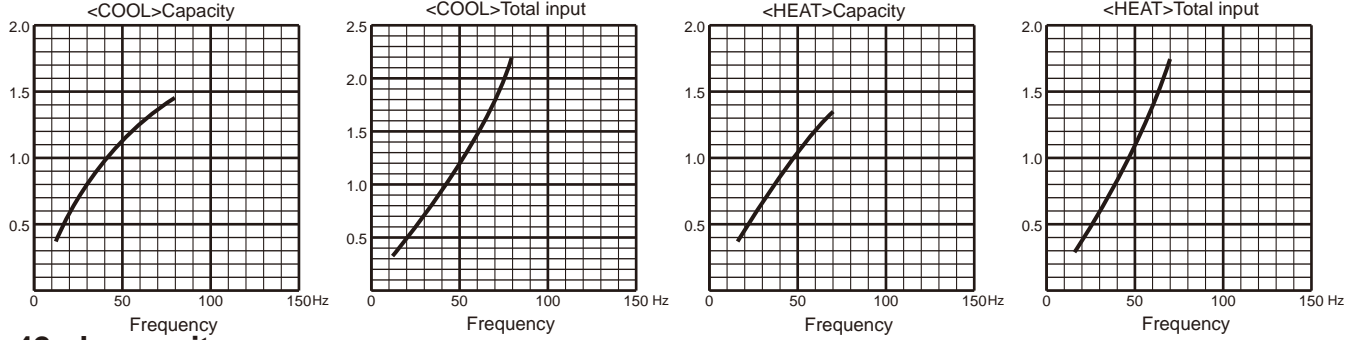

42-class unit

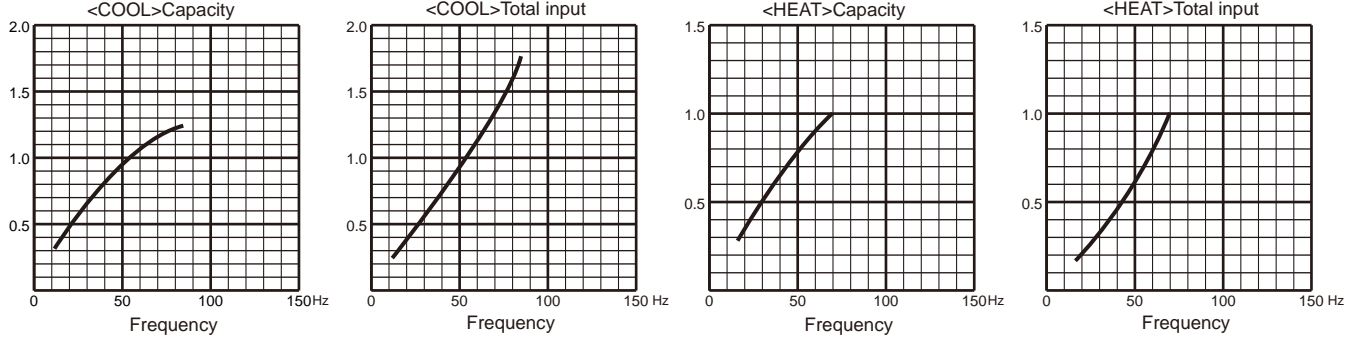

MXZ-3HA50VF

25-class unit

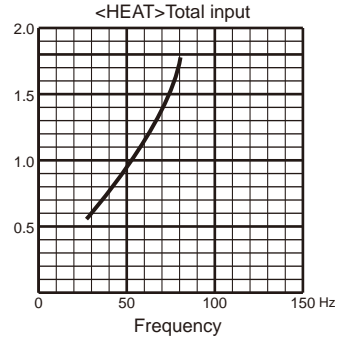
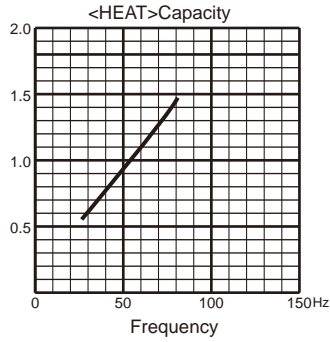
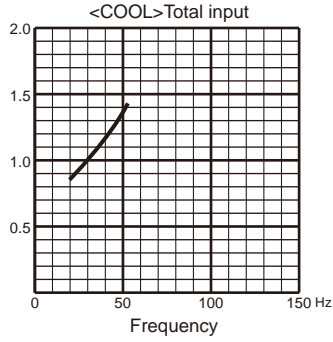
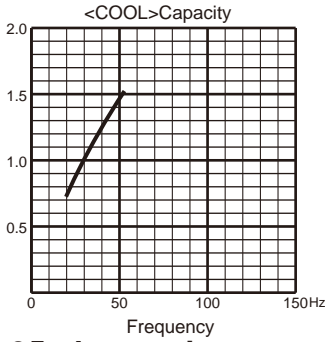

35-class unit

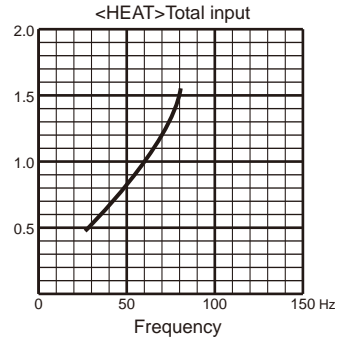
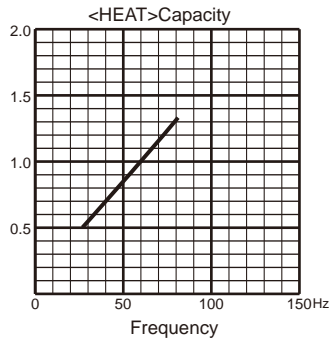
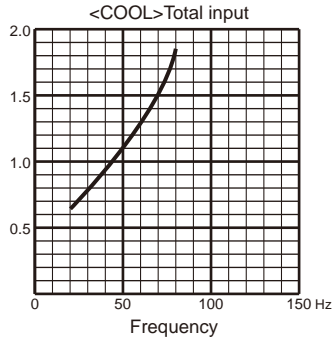
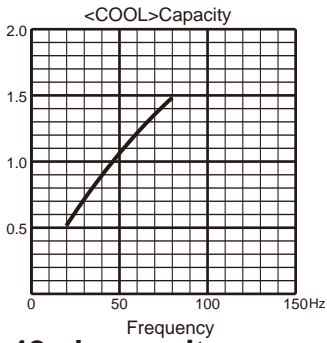

42-class unit

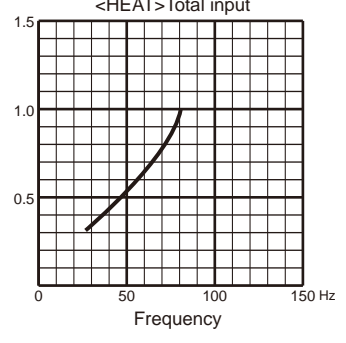
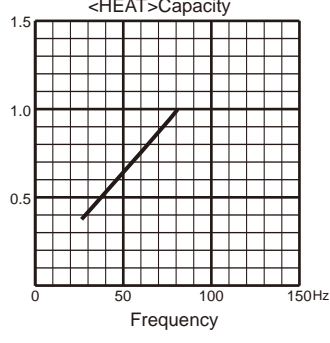
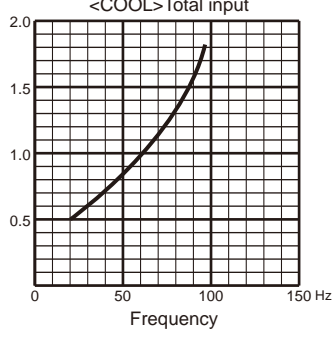
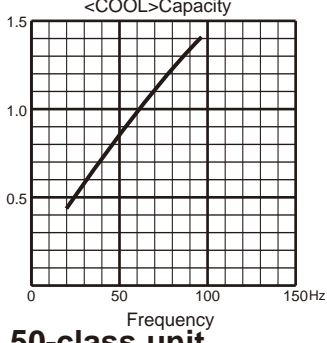

50-class unit

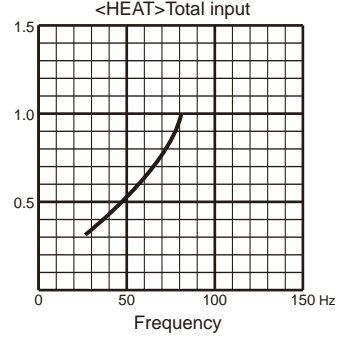
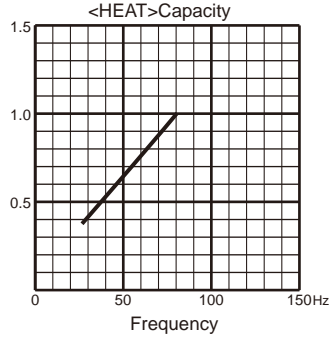
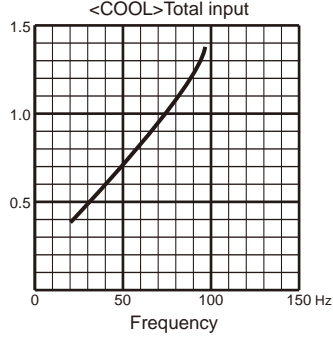
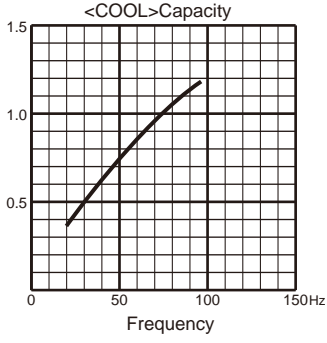

9-3. HOW TO OPERATE FIXED-FREQUENCY OPERATION <Test run operation>

1. Press the emergency operation switch to start COOL or HEAT mode (COOL : Press once, HEAT : Press twice).
2. Test run operation starts and continues to operate for 30 minutes.
3. Compressor operates at rated frequency.
4. Indoor fan operates at High speed.
5. After 30 minutes, test run operation finishes and EMERGENCY OPERATION starts (Operation frequency of compressor varies).
6. To cancel test run operation or EMERGENCY OPERATION, press the emergency operation switch or any button on remote controller.

9-4. OUTDOOR LOW PRESSURE AND OUTDOOR UNIT CURRENT CURVE (single operation)

NOTE: The unit of pressure has been changed to MPa on the international system of units (SI unit system).
The conversion factor is : **1 (MPa [Gauge]) = 10.2 (kgf/cm² [Gauge])**

(1) COOL operation

- ① Both indoor and outdoor units are under the same temperature/humidity condition.
- ② Operation : TEST RUN OPERATION (Refer to 9-3.)

Dry-bulb temperature (°C)	Relative humidity (%)
20	50
25	60
30	70

MXZ-2HA40VF

25-class unit

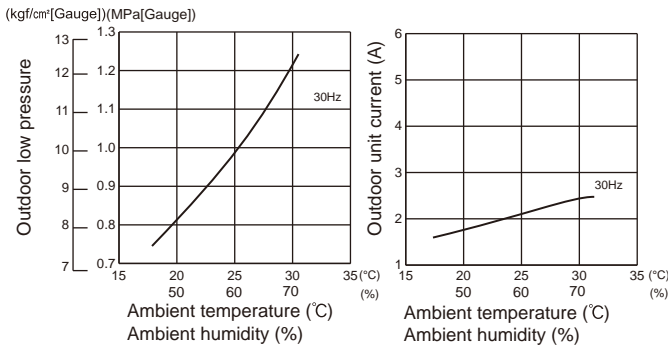

35-class unit

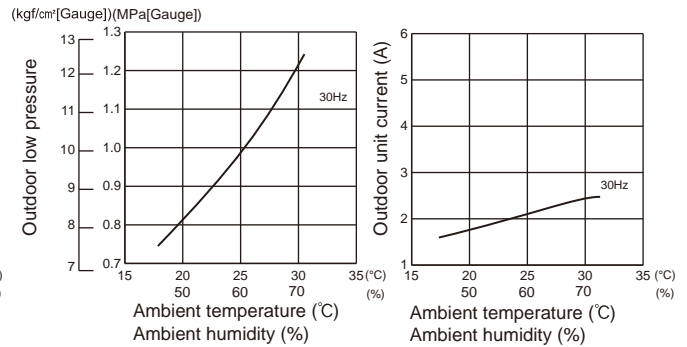

MXZ-2HA50VF

25-class unit

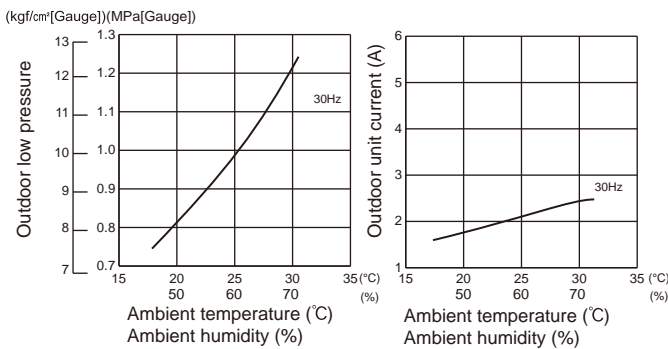

35-class unit

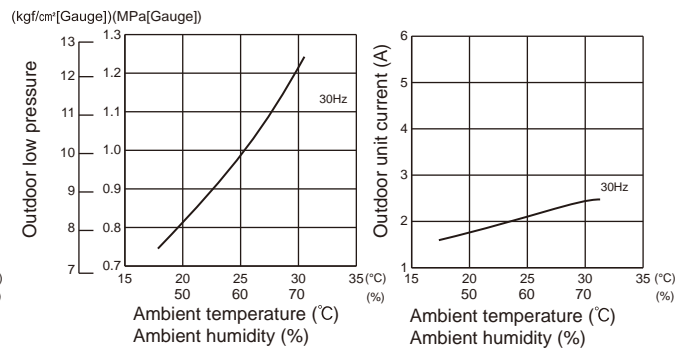

42-class unit

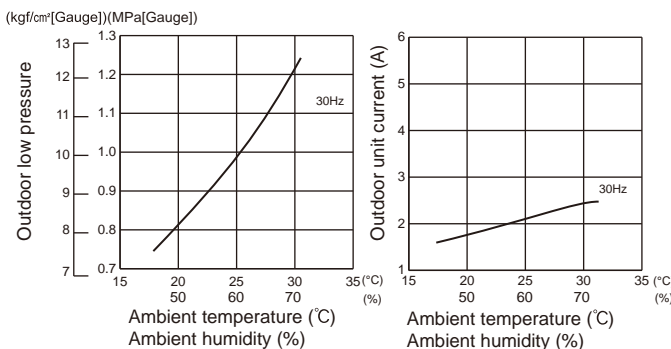

MXZ-3HA50VF

25-class unit

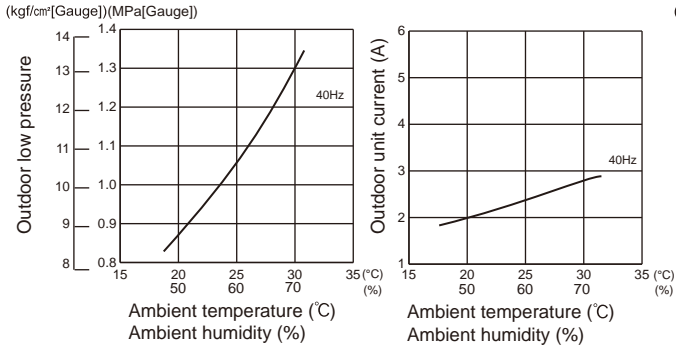

35-class unit

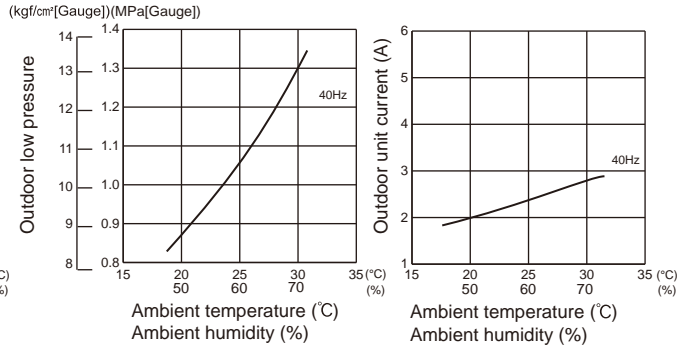

42-class unit

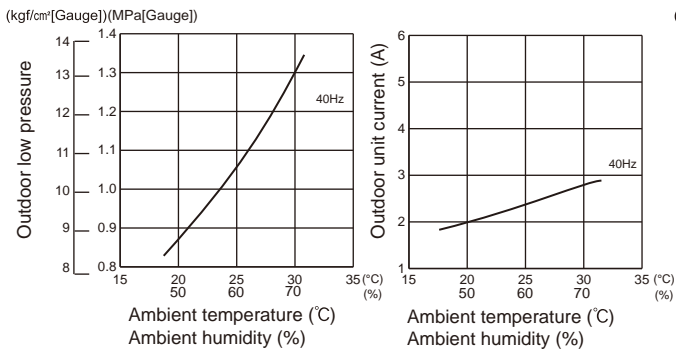

50-class unit

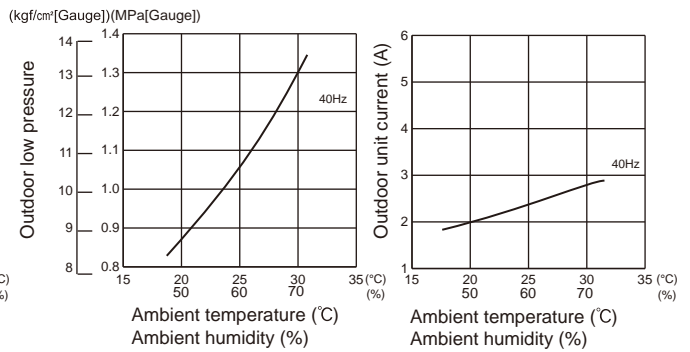

(2) HEAT operation

① Condition :

	Indoor	Outdoor			
Dry bulb temperature (°C)	20.0	2	7	15	20.0
Wet bulb temperature (°C)	14.5	1	6	12	14.5

② Operation : TEST RUN OPERATION (Refer to 9-3.)

MXZ-2HA40VF

25-class unit

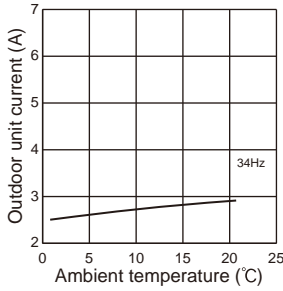

35-class unit

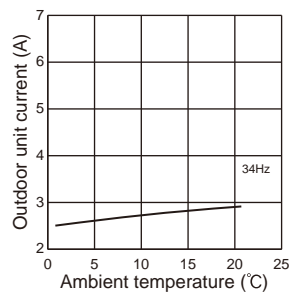

MXZ-2HA50VF

25-class unit

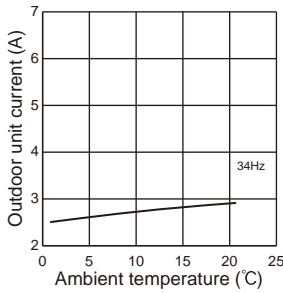

35-class unit

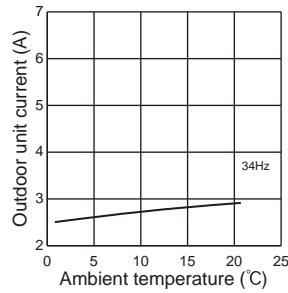

42-class unit

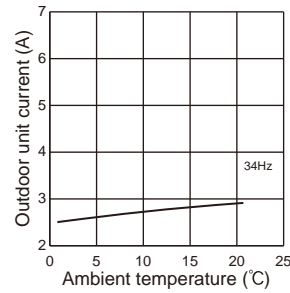

MXZ-3HA50VF

25-class unit

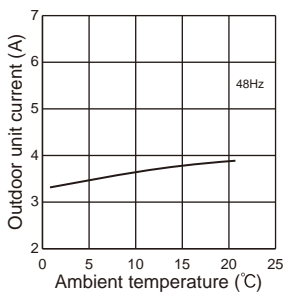

35-class unit

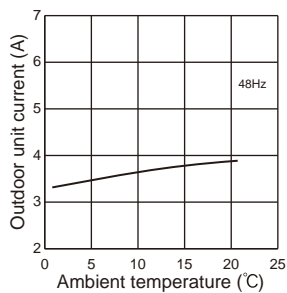

42-class unit

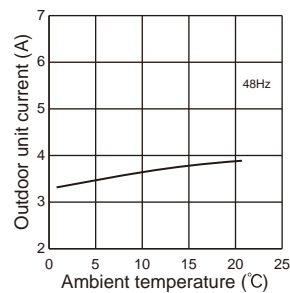

50-class unit

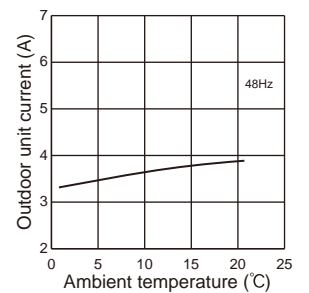

MXZ-2HA40VF MXZ-2HA50VF**Relation between main sensor and actuator**

Sensor	Purpose	Actuator			
		Compressor	LEV	Outdoor fan motor	R.V. coil
Discharge temperature thermistor	Protection	○	○		
Indoor coil temperature thermistor	Cooling: Coil frost prevention	○			
	Heating: High pressure protection	○	○		
Defrost thermistor	Heating: Defrosting	○	○	○	○
Fin temperature thermistor	Protection	○		○	
Ambient temperature thermistor	Control/Protection	○	○	○	
	Heating: Defrosting (Heater)				
Outdoor heat exchanger temperature thermistor	Cooling: Control/Protection	○	○	○	
Capacity code	Control	○	○		

MXZ-3HA50VF**Relation between main sensor and actuator**

Sensor	Purpose	Actuator			
		Compressor	LEV	Outdoor fan motor	4-way valve
Discharge temperature thermistor	Protection	○	○		
Indoor coil temperature thermistor	Cooling: Coil frost prevention	○			
	Heating: High pressure protection	○	○		
Defrost thermistor	Heating: Defrosting	○	○	○	○
Fin temperature thermistor	Protection	○		○	
Ambient temperature thermistor	Control/Protection	○	○	○	
	Heating: Defrosting (Heater)				
Outdoor heat exchanger temperature thermistor	Cooling: Control/Protection	○	○	○	
Capacity code	Control	○	○		

MXZ-2HA40VF MXZ-2HA50VF MXZ-3HA50VF

11-1. THE POSITION OF SWITCH

<MXZ-2HA40VF/2HA50VF>

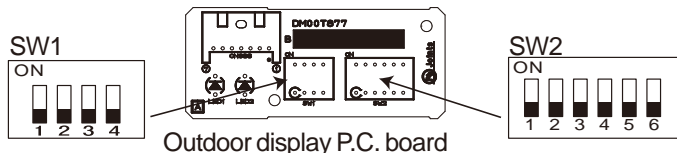

<MXZ-3HA50VF>

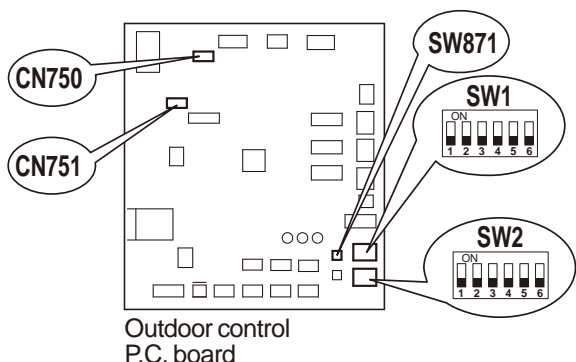

11-2. LOCKING THE OPERATION MODE OF THE AIR CONDITIONER (COOL, DRY, HEAT)

With this function, once the operation mode is locked to either COOL/DRY mode or HEAT mode, the air conditioner operates in that mode only.

Changing the setting is required to activate this function. Explain about this function to your customers and ask them whether they want to use it.

[How to lock the operation mode]

- (1) Turn OFF the power supply and make sure that the LED goes off.
- (2) Set SW1 as shown in the figure below.
- (3) Turn ON the power supply.

<MXZ-2HA40VF/2HA50VF>

SW1 on the outdoor display P.C. board

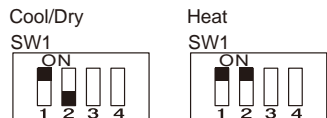

<MXZ-3HA50VF>

SW1 on the outdoor control P.C. board

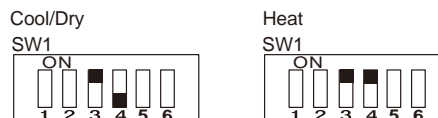

11-3. LOWERING THE OPERATING NOISE OF THE OUTDOOR UNIT

With this function, the operating noise of the outdoor unit can be lowered by reducing the operation load, for example, during nighttime in COOL mode.

However, note that the cooling and heating capacity may lower if this function is activated.

Changing the setting is required to activate this function. Explain about this function to your customers and ask them whether they want to use it.

[How to lower the operating noise]

- (1) Turn OFF the power supply and make sure that the LED goes off.
- (2) Set "3" on SW1 to ON to enable this function. (**MXZ-2HA40VF/2HA50VF**)
Set "5" on SW1 to ON to enable this function. (**MXZ-3HA50VF**)
- (3) Turn ON the power supply.

<MXZ-2HA40VF/2HA50VF>

SW1 on the outdoor display P.C. board



<MXZ-3HA50VF>

SW1 on the outdoor control P.C. board



11-4. AUTOMATIC LINE CORRECTING

<MXZ-2HA40VF/2HA50VF>

This outdoor unit has an automatic line correcting function which automatically detects and corrects improper wiring or piping.

<MXZ-2HA40VF/2HA50VF>

Improper wiring or piping can be automatically detected when one indoor unit is operated in COOL mode for 30 minutes. When improper wiring or piping is detected, wiring lines are corrected (A to B/ B to A) with the software.

NOTE: This function may not work due to the condition or environment of the unit, such as the following:

- gas leak, closed stop valve
- unit failure such as defective LEV
- indoor/outdoor temperature

NOTE: This function does not work when "2" on SW2 on the outdoor display P.C. board is turned OFF.

<Correct>

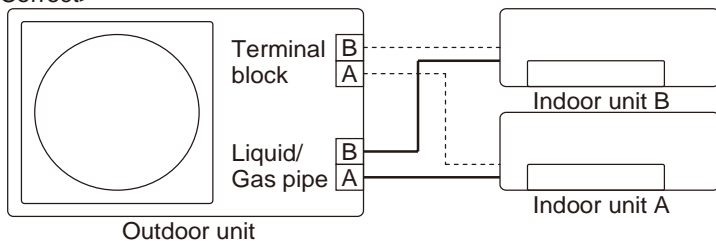

MXZ-2HA40VF/2HA50VF
SW2 on the outdoor display P.C. board

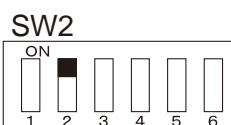

<Incorrect wiring>

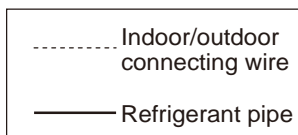
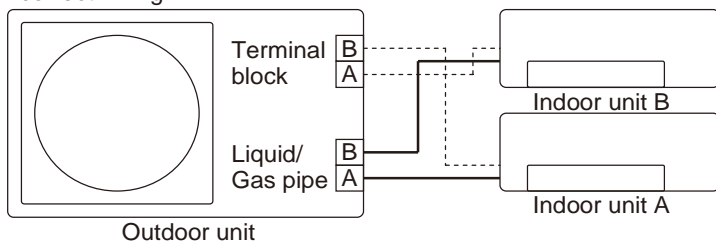

<Incorrect piping>

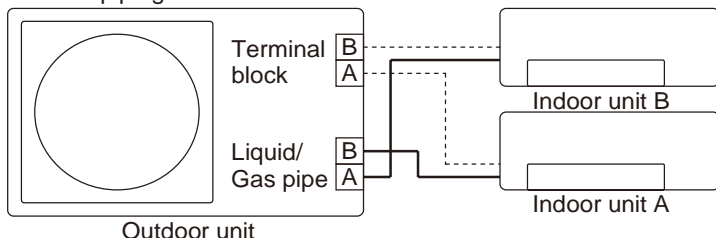

The record of automatic line correcting can be checked in the following way:

- (1) Turn OFF the power supply and make sure that the LED goes off.
- (2) Turn ON "3" on SW2 on the outdoor display P.C. board.
- (3) Turn ON the power supply.
- (4) Check the correction state with the LED lamps on the outdoor display P.C. board.
- (5) Turn OFF the power supply and make sure that the LED goes off.
- (6) Turn OFF "3" on SW2 on the outdoor display P.C. board.
- (7) Turn ON the power supply.

Number of blinks		Wiring line
LED1 (Red)	LED2 (Yellow)	
Once	Once	Not corrected
3 times	3 times	Corrected

MXZ-2HA40VF/2HA50VF
SW2 on the outdoor display P.C. board

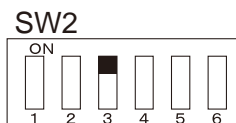

<MXZ-3HA50VF>

Outdoor unit has an auto line correcting function which automatically detects and corrects improper wiring or piping.

Improper wiring or piping can be automatically detected by pressing the piping/wiring correction switch (SW871).
When improper wiring or piping is detected, wiring lines are corrected.
This will be completed in about 10 to 15 minutes.

[How to activate this function]

1. Check that outside temperature is above 0°C.
(This function does not work when the outside temperature is 0°C or below.)
2. Check that the stop valves of the liquid pipe and gas pipe are open.
3. Check that the wiring between indoor and outdoor unit is correct.
(If the wiring is not correct, this function does not work.)
4. Turn ON the power supply and wait at least 1 minute.
5. Press the piping/wiring correction switch (SW871) on the outdoor control P.C. board.
Do not touch energized parts.

LED indication during detection:

LED1 (Red)	LED2 (Yellow)	LED3 (Green)
Lit	Lit	Once

LED indication after detection:

LED1 (Red)	LED2 (Yellow)	LED3 (Green)	Result
Lit	Not lit	Lit	Completed (Problem corrected/ normal)
Once	Once	Once	Not completed (Detection failed)
Other indications			Refer to "SAFETY PRECAUTIONS WHEN LED BLINKS" located behind the top panel.

* Make sure that the valves are open and the pipes are not collapsed or clogged.

6. Press the switch to cancel.

LED indication after cancel :

LED1 (Red)	LED2 (Yellow)	LED3 (Green)
Lit	Lit	Not lit

NOTE: Indoor unit cannot be operated while this function is activated.

When this function is activated while indoor unit is operating, the operation will be stopped.

Operate indoor unit after the auto line correcting is finished.

Pressing the switch during detection cancels this function.

The record of auto line correcting can be confirmed in the following way:

Press the switch for more than 5 seconds.

LED will show the record of auto correcting for about 30 seconds as shown in the table below:

Number of blinks			Wiring line
LED1 (Red)	LED2 (Yellow)	LED3 (Green)	
Once	Once	Lit	Not corrected
3 times	3 times	Lit	Corrected

NOTE: Activate this function to confirm the correct wiring after replacing the outdoor control P.C. board.

(Previous records are deleted when the outdoor control P.C. board is replaced.)

The record cannot be shown if auto line correcting is not canceled (Refer to "How to activate this function").

MXZ-2HA40VF MXZ-2HA50VF MXZ-3HA50VF

12-1. CAUTIONS ON TROUBLESHOOTING

1. Before troubleshooting, check the following:

- 1) Check the power supply voltage.
- 2) Check the indoor/outdoor connecting wire for miswiring.

2. Take care of the following during servicing

- 1) Before servicing the air conditioner, be sure to turn OFF the unit first with the remote controller, and after confirming the horizontal vane is closed, turn OFF the breaker and/or disconnect the power plug.
- 2) Be sure to turn OFF the power supply before removing the front panel, the cabinet, the top panel, and the P.C. board.
- 3) When removing the electrical parts, be careful of the residual voltage of smoothing capacitor.
- 4) When removing the P.C. board, hold the edge of the board with care NOT to apply stress on the components.
- 5) When connecting or disconnecting the connectors, hold the connector housing. DO NOT pull the lead wires.

<Incorrect>



Lead wiring

<Correct>

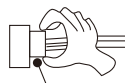

Connector housing

3. Troubleshooting procedure

- 1) Check if the OPERATION INDICATOR lamp on the indoor unit is blinking on and off to indicate an abnormality. To make sure, check how many times the OPERATION INDICATOR lamp is blinking on and off before starting service work.
- 2) Before servicing, verify that all connectors and terminals are connected properly.
- 3) When the electronic control P.C. board seems to be defective, check for disconnection of the copper foil pattern and burnt or discolored components.
- 4) Refer to 12-2, 12-3 and 12-4.

12-2. FAILURE MODE RECALL FUNCTION

This air conditioner can memorize the abnormal condition which has occurred once.

Even though LED indication listed on the troubleshooting check table (12-4.) disappears, the memorized failure details can be recalled.

1. Flow chart of failure mode recall function for the indoor/outdoor unit

Refer to the service manual of indoor unit.

2. Flow chart of the detailed outdoor unit failure mode recall function

Operational procedure

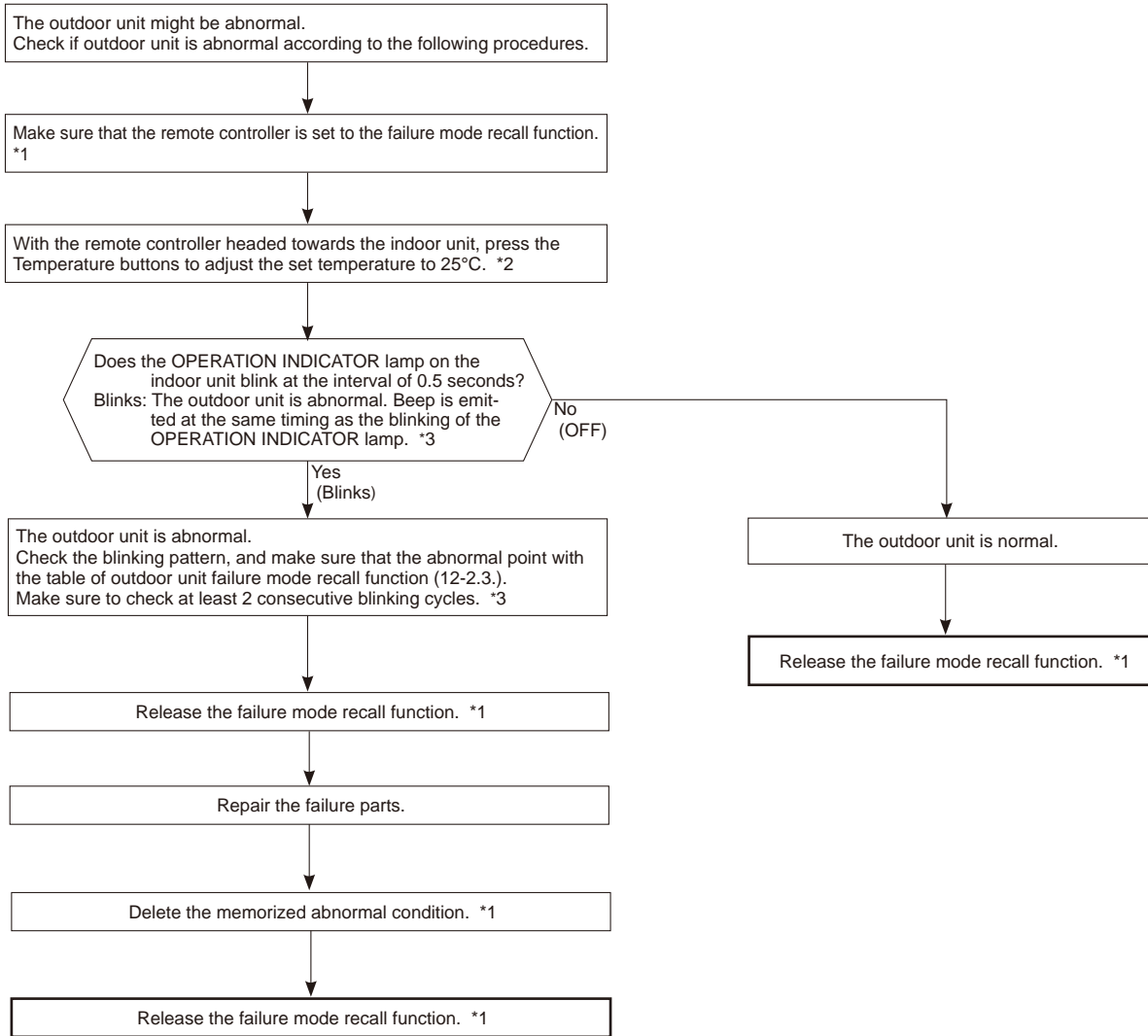

NOTE: 1. Make sure to release the failure mode recall function after it is set up, otherwise the unit cannot operate properly.
2. If the abnormal condition is not deleted from the memory, the last abnormal condition is kept memorized.

*1. Refer to the service manual of indoor unit.

*2. Regardless of normal or abnormal condition, 2 short beeps are emitted as the signal is received.

*3. Blinking pattern when outdoor unit is abnormal:

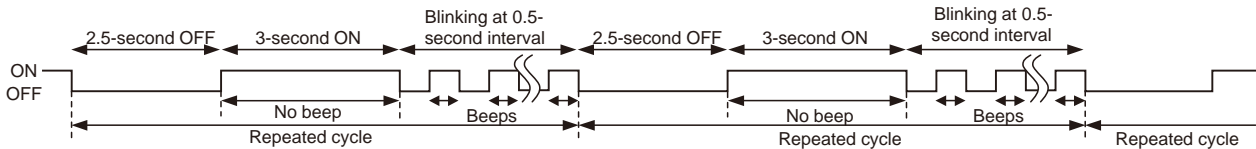

3. Table of outdoor unit failure mode recall function MXZ-2HA

NOTE: Blinking patterns of this mode differ from the ones of Troubleshooting check table (12-4).

Upper or left lamp of OPERATION INDICATOR lamp (Indoor unit)	Abnormal point (Failure mode/protection)	LED indication (Outdoor P.C. board)		Condition	Remedy	Indoor/outdoor unit failure mode recall function
		LED 1	LED 2			
OFF	None (Normal)	Not lit	Not lit	—	—	—
2-time blink	Outdoor power system	Lit	Lit	Overcurrent protection cut-out operates 3 consecutive times within 1 minute after the compressor gets started. Compressor protection cut-out operates 24 consecutive times within 10 seconds after the compressor gets started.	<ul style="list-style-type: none"> • Check the compressor connecting wire. • Refer to 12-6. ⑥ "How to check inverter/compressor". • Check the stop valve. 	○
3-time blink	Discharge temperature thermistor	Lit	Once	Thermistor shorts or opens during compressor running.	<ul style="list-style-type: none"> • Refer to 12-6. ⑥ "Check of outdoor thermistors". 	○
	Defrost thermistor	Lit	Once			○
	Ambient temperature thermistor	Lit	Twice			○
	Fin temperature thermistor	Lit	3 times			○
	P.C. board temperature thermistor	Lit	4 times			○
	Outdoor heat exchanger temperature thermistor	Lit	9 times			○
4-time blink	Overcurrent	Once	Not lit	The overcurrent flows into intelligent power module.	<ul style="list-style-type: none"> • Check the compressor connecting wire. • Refer to 12-6. ⑥ "How to check inverter/compressor". • Check the stop valve. 	—
	Compressor	Twice	Not lit	The overcurrent flows into intelligent power module within 10 seconds after the compressor gets started. (The compressor gets restarted in 15 seconds.)	<ul style="list-style-type: none"> • Check the compressor connecting wire. • Refer to 12-6. ⑥ "How to check inverter/compressor". 	—
		9 times	Not lit	Waveform of compressor current is distorted.		—
5-time blink	Discharge temperature	Lit	Lit	Discharge temperature exceeds 116°C during operation.	<ul style="list-style-type: none"> • Check the refrigerant circuit and the refrigerant amount. • Refer to 12-6. ⑥ "Check of LEV". 	—
6-time blink	High pressure	Lit	Lit	The outdoor heat exchanger temperature exceeds 70°C during cooling or the indoor gas pipe temperature exceeds 70°C during heating.	<ul style="list-style-type: none"> • Check the refrigerant circuit and the refrigerant amount. • Check the stop valve. 	—
7-time blink	Fin temperature	3 times	Not lit	The fin temperature exceeds 90°C during operation.	<ul style="list-style-type: none"> • Check the around outdoor unit. • Check the outdoor unit air passage. 	—
	P.C. board temperature	4 times	Not lit	The P.C. board temperature exceeds 80°C during operation.	<ul style="list-style-type: none"> • Refer to 12-6. ⑥ "Check of outdoor fan motor". 	—
8-time blink	Outdoor fan motor	Lit	Lit	Failure occurs 3 consecutive times within 30 seconds after the fan gets started.	<ul style="list-style-type: none"> • Refer to 12-6. ⑥ "Check of outdoor fan motor". 	—
9-time blink	Nonvolatile memory data	Lit	5 times	Nonvolatile memory data cannot be read properly.	<ul style="list-style-type: none"> • Replace the inverter P.C. board. 	○
	Power module	7 times	Not lit	The output of the power module that drove the compressor was shorted or the winding of the compressor was shorted.	<ul style="list-style-type: none"> • Refer to 12-6. ⑥ "How to check inverter/compressor". 	○
10-time blink	Discharge temperature	Lit	Lit	The discharge temperature is kept under 50°C (COOL mode)/40°C (HEAT mode) for more than 40 minutes.	<ul style="list-style-type: none"> • Check the refrigerant circuit and the refrigerant amount. • Refer to 12-6. ⑥ "Check of LEV". 	—
11-time blink	Current sensor	8 times	Not lit	The sensor circuit of current of compressor shorts or opens during compressor operate.	<ul style="list-style-type: none"> • Replace the inverter P.C. board. 	○
	Bus-bar voltage	6 times	Not lit	The bus-bar voltage exceeds 430 V or falls to 50 V or below during compressor operating.	<ul style="list-style-type: none"> • Check the power supply. • Replace the inverter P.C. board. 	○
14-time blink	Stop valve	Lit	12 times	The current of compressor is power module is out of order.	<ul style="list-style-type: none"> • Check the stop valve. • Check the refrigerant circuit and the refrigerant amount. 	○
17 time blink	Outdoor refrigerant system abnormality	Lit	17 times	A closed valve and air trapped in the refrigerant circuit are detected based on the temperature sensed by the indoor and outdoor thermistors and the current of the compressor.	<ul style="list-style-type: none"> • Check for a gas leak in a connecting piping etc. • Check the stop valve. • Refer to 12-6. ⑥ "Check of outdoor refrigerant circuit". 	○

NOTE: Blinking patterns of this mode differ from the ones of Troubleshooting check table (12-4.).

MXZ-3HA

The left lamp of OPERATION INDICATOR lamp (Indoor unit)	Abnormal point (Failure mode/protection)	LED indication (Outdoor P.C. board)		Condition	Remedy	Indoor/outdoor unit failure mode recall function
		LED1	LED2			
OFF	None (Normal)	Lit	Lit			
2-time blink	Outdoor power system	Lit	Lit	Overcurrent protection cut-out operates 3 consecutive times within 1 minute after the compressor gets started, or converter protection cut-out or bus-bar voltage protection cut-out operates 3 consecutive times within 3 minutes after startup.	<ul style="list-style-type: none"> Check the connection of the compressor connecting wire. Refer to 12-6. ㉔ "How to check inverter/compressor". Check the stop valve. 	○
3-time blink	Discharge temperature thermistor	Lit	Once	A thermistor shorts or opens during compressor running.	<ul style="list-style-type: none"> Refer to 12-6. ㉔ "Check of outdoor thermistors". 	○
	Defrost thermistor	Lit	Once			
	Ambient temperature thermistor	Lit	Twice			
	Fin temperature thermistor	Lit	3 times			
	P.C. board temperature thermistor	Lit	4 times			
Outdoor heat exchanger temperature thermistor	Lit	9 times				
4-time blink	Overcurrent	Once	Not lit	21 A current flows into power module.	<ul style="list-style-type: none"> Reconnect compressor connector. Refer to 12-6. ㉔ "How to check inverter/compressor". Check the stop valve. 	—
5-time blink	Discharge temperature	Lit	Lit	The discharge temperature exceeds 115°C during operation. Compressor can restart if discharge temperature thermistor reads 80°C or less 3 minutes later.	<ul style="list-style-type: none"> Check refrigerant circuit and refrigerant amount. Refer to 12-6. ㉔ "Check of LEV". 	—
6-time blink	High pressure	Lit	Lit	The outdoor heat exchanger temperature exceeds 70°C during cooling or the indoor gas pipe temperature exceeds 70°C during heating.	<ul style="list-style-type: none"> Check refrigerant circuit and refrigerant amount. Check the stop valve. 	—
7-time blink	Fin temperature	3 times	Not lit	The fin temperature exceeds 88°C during operation.	<ul style="list-style-type: none"> Check around outdoor unit. Check outdoor unit air passage. Refer to 12-6. ㉔ "Check of outdoor fan motor". 	—
	P.C. board temperature	4 times	Not lit	The P.C. board temperature exceeds 67°C during operation.		
8-time blink	Outdoor fan motor	Lit	Lit	A failure occurs 3 consecutive times within 30 seconds after the fan gets started.	<ul style="list-style-type: none"> Refer to 12-6. ㉔ "Check of outdoor fan motor". 	—
9-time blink	Outdoor control system	Lit	5 times	Nonvolatile memory data cannot be read properly.	<ul style="list-style-type: none"> Replace the outdoor control P.C. board. 	○
10-time blink	Low discharge temperature protection	Lit	Lit	The frequency of the compressor is kept 80 Hz or more and the discharge temperature is kept under 39°C for more than 20 minutes.	<ul style="list-style-type: none"> Check refrigerant circuit and refrigerant amount. Refer to 12-6. ㉔ "Check of LEV". 	—
11-time blink	Communication error between P.C. boards	Lit	6 times	Communication error occurs between the outdoor control P.C. board and outdoor power P.C. board for more than 10 seconds.	<ul style="list-style-type: none"> Check the connecting wire between outdoor control P.C. board and outdoor power P.C. board. 	—
				The communication between boards protection cut-out operates 2 consecutive times.		○
	Current sensor	Lit	7 times	A short or open circuit is detected in the current sensor during compressor operating.	—	—
				Current sensor protection cut-out operates 2 consecutive times.		○
	Zero cross detecting circuit	5 times	Not lit	Zero cross signal cannot be detected while the compressor is operating.	<ul style="list-style-type: none"> Check the connecting wire among outdoor control P.C. board and outdoor power P.C. board. 	—
				The protection cut-out of the zero cross detecting circuit operates 10 consecutive times.		○
Converter	5 times	Not lit	A failure is detected in the operation of the converter during operation.	<ul style="list-style-type: none"> Check the voltage of power supply. Replace the outdoor power P.C. board. 	—	
Bus-bar voltage	5 times	Not lit	The bus-bar voltage exceeds 400 V or falls to low level during compressor operating.	<ul style="list-style-type: none"> Check the voltage of power supply. Replace the outdoor control P.C. board. 	—	
15-time blink	LEV and drain pump	Lit	Lit	The indoor unit detects an abnormality in the LEV and drain pump.	<ul style="list-style-type: none"> Refer to 12-6. ㉔ "Check of LEV". Check the drain pump of the indoor unit. 	—

12-3. INSTRUCTION OF TROUBLESHOOTING

- Check the indoor unit referring to the indoor unit service manual, and confirm that there is any problem in the indoor unit. Then, check the outdoor unit with referring to this page.

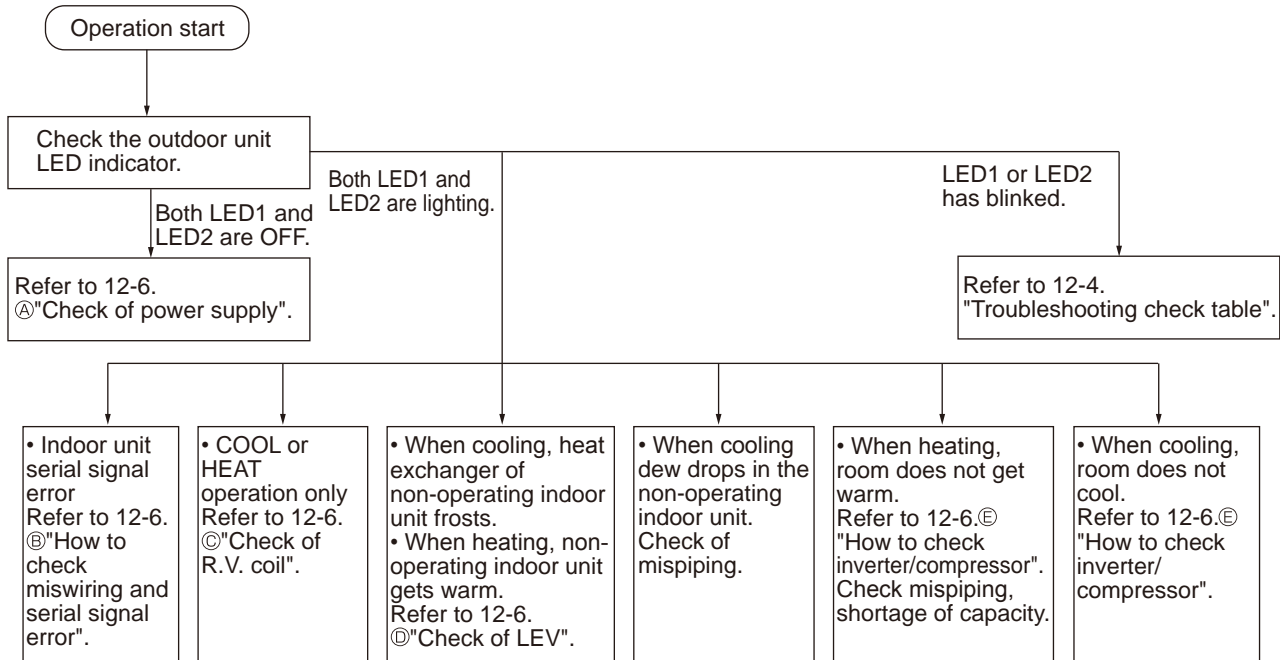

12-4. TROUBLESHOOTING CHECK TABLE

MXZ-2HA

No.	Symptom	Indication		Abnormal point / Condition	Condition	Remedy
		LED1(Red)	LED2(Yellow)			
1	Outdoor unit does not operate.	Lit	Once	LEV and drain pump	The indoor unit detects an abnormality in the LEV and drain pump.	<ul style="list-style-type: none"> Refer to 12-6. ㉔ "Check of LEV". Check the drain pump of the indoor unit.
2		Lit	Twice	Outdoor power system	Overcurrent protection cut-out operates 3 consecutive times within 1 minute after the compressor gets started.	<ul style="list-style-type: none"> Check the connection of the compressor connecting wire. Refer to 12-6. ㉕ "How to check inverter/compressor". Check the stop valve.
3		Lit	3 times	Discharge temperature thermistor	A short circuit is detected in the thermistor during operation, or when an open circuit is detected in the thermistor after 10 minutes of compressor startup.	Refer to 12-6. ㉖ "Check of outdoor thermistors".
4		Lit	4 times	Fin temperature thermistor	A short or open circuit is detected in the thermistor during operation.	Refer to 12-6. ㉖ "Check of outdoor thermistors".
				P.C board temperature thermistor		
5		Lit	5 times	Ambient temperature thermistor	A short or open circuit is detected in the thermistor during operation.	Refer to 12-6. ㉖ "Check of outdoor thermistors".
				Outdoor heat exchanger temperature thermistor	A short circuit is detected in the thermistor during operation, or when an open circuit is detected in the thermistor after 5 minutes (in cooling) and 10 minutes (in heating) of compressor startup.	
	Defrost thermistor			A short circuit is detected in the thermistor during operation, or when an open circuit is detected in the thermistor after 5 minutes of compressor startup.		
6	Lit	7 times	Nonvolatile memory data	The nonvolatile memory data cannot be read properly.	Replace the inverter P.C. board.	
7	Lit	17 times	Outdoor refrigerant system abnormality	A closed valve and air trapped in the refrigerant circuit are detected based on the temperature sensed by the indoor and outdoor thermistors and the current of the compressor.	<ul style="list-style-type: none"> Check for a gas leak in a connecting piping etc. Check the stop valve. Refer to 12-6. ㉗ "Check of outdoor refrigerant circuit". 	
8	'Outdoor unit stops and restarts 3 minutes later' is repeated.	Twice	Not lit	Overcurrent	18 A current flows into intelligent power module.	<ul style="list-style-type: none"> Reconnect compressor connector. Refer to 12-6. ㉕ "How to check inverter/compressor". Check the stop valve.
9		3 times	Not lit	Discharge temperature protection	Discharge temperature exceeds 116°C during operation. Compressor can restart if discharge temperature thermistor reads 100°C or less 3 minutes later.	<ul style="list-style-type: none"> Check the amount of gas and the refrigerant circuit. Refer to 12-6. ㉔ "Check of LEV".
10		4 times	Not lit	Fin temperature protection	The fin temperature exceeds 90°C during operation.	<ul style="list-style-type: none"> Check the refrigerant circuit and the refrigerant amount. Refer to 12-6. ㉘ "Check of outdoor fan motor".
				P.C. board temperature protection	The P.C. board temperature exceeds 78°C during operation.	
11		5 times	Not lit	High pressure protection	The outdoor heat exchanger temperature exceeds 70°C during cooling or indoor gas pipe temperature exceeds 70°C during heating.	<ul style="list-style-type: none"> Check the amount of gas and the refrigerant circuit. Check the stop valve.
12		9 times	Not lit	Bus-bar voltage protection	The bus-bar voltage exceeds 430 V or falls to 50 V or below during compressor operating.	Replace the inverter P.C. board.
13		13 times	Not lit	Outdoor fan motor	Failure occurs 3 consecutive times within 30 seconds after the fan gets started.	Refer to 12-6. ㉘ "Check of outdoor fan motor".
14		8 times	Not lit	Current sensor protection	A short or open circuit is detected in the current sensor during compressor operating.	Replace the inverter P.C. board.
15		10 times	Not lit	Compressor	The compressor does not synchronize with the operating power.	<ul style="list-style-type: none"> Reconnect compressor connector. Refer to 12-6. ㉕ "How to check inverter/compressor". Check the stop valve.
16	Outdoor unit operates.	Once	Lit	Primary current protection	The input current exceeds 10 A.	<p>These symptoms do not mean any abnormality of the product, but check the following points.</p> <ul style="list-style-type: none"> Check if indoor filters are clogged. Check if refrigerant is short. Check if indoor/outdoor unit air circulation is short cycled.
Secondary current protection				The current of the compressor exceeds 17 A.		
17		Twice	Lit	High pressure protection	The indoor gas pipe temperature exceeds 45°C during heating.	
				Defrosting in cooling	The indoor gas pipe temperature falls 3°C or below during cooling.	
18	3 times	Lit	Discharge temperature protection	The discharge temperature exceeds 100°C during operation.	<ul style="list-style-type: none"> Check the refrigerant circuit and the refrigerant amount. Refer to 12-6. ㉔ "Check of LEV". Refer to 12-6. ㉖ "Check of outdoor thermistors". 	
19	4 times	Lit	Low discharge temperature protection	The frequency of the compressor is kept 80 Hz or more and the discharge temperature is kept under 50°C (COOL mode)/40°C (HEAT mode) for more than 40 minutes.	<ul style="list-style-type: none"> Refer to 12-6. ㉔ "Check of LEV". Check the refrigerant circuit and the refrigerant amount. 	



No.	Symptom	Indication		Abnormal point / Condition	Condition	Remedy
		LED1(Red)	LED2(Yellow)			
20	Outdoor unit operates.	5 times	Lit	Cooling high pressure protection	The outdoor heat exchanger temperature exceeds 58°C during operation.	This symptom does not mean any abnormality of the product, but check the following points. <ul style="list-style-type: none"> • Check if indoor filters are clogged. • Check if refrigerant is short. • Check if indoor/outdoor unit air circulation is short cycled.
21		8 times	Lit	Converter protection	A failure is detected in the operation of the converter during operation.	<ul style="list-style-type: none"> • Check the voltage of power supply. • Replace the inverter P.C. board.
22	Outdoor unit operates normally.	9 times	Lit	Inverter check mode	The connector of compressor is disconnected. Inverter check mode starts.	—
23		Lit	Lit	Normal	—	—

NOTE: 1. The location of LED is illustrated at the right figure. Refer to 12-7.4.
 2. LED is lighted during normal operation.

The blinking frequency shows the number of times the LED blinks after every 2.5-second OFF.
 (Example) The blinking frequency is "2".

Outdoor display P.C. board (Parts side)

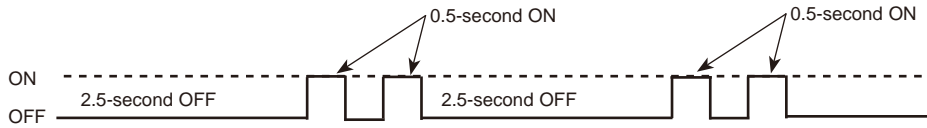
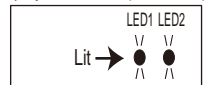

MXZ-3HA

No.	Symptom	Indication		Abnormal point / Condition	Condition	Remedy
		LED1(Red)	LED2(Yellow)			
1	Outdoor unit does not operate.	Lit	Once	LEV and drain pump	The indoor unit detects an abnormality in the LEV and drain pump.	<ul style="list-style-type: none"> Refer to 12-6. ㉔ "Check of LEV". Check the drain pump of the indoor unit.
2		Lit	Twice	Outdoor power system	Overcurrent protection cut-out operates 3 consecutive times within 1 minute after the compressor gets started, or converter protection cut-out or bus-bar voltage protection cut-out operates 3 consecutive times within 3 minutes after startup.	<ul style="list-style-type: none"> Check the connection of the compressor connecting wire. Refer to 12-6. ㉕ "How to check inverter/compressor". Check the stop valve.
3		Lit	3 times	Discharge temperature thermistor	A short circuit is detected in the thermistor during operation, or an open circuit is detected in the thermistor after 10 minutes of compressor startup.	<ul style="list-style-type: none"> Refer to 12-6. ㉖ "Check of outdoor thermistors".
4		Lit	4 times	Fin temperature thermistor	A short or open circuit is detected in the thermistor during operation.	<ul style="list-style-type: none"> Refer to 12-6. ㉖ "Check of outdoor thermistors".
				P. C. board temperature thermistor		<ul style="list-style-type: none"> Replace the outdoor control P.C. board.
5		Lit	5 times	Ambient temperature thermistor	A short or open circuit is detected in the thermistor during operation.	<ul style="list-style-type: none"> Refer to 12-6. ㉖ "Check of outdoor thermistors".
				Outdoor heat exchanger temperature thermistor	A short circuit is detected in the thermistor during operation, or an open circuit is detected in the thermistor after 5 minutes (in cooling) and 10 minutes (in heating) of compressor startup.	
				Defrost thermistor	A short circuit is detected in the thermistor during operation, or an open circuit is detected in the thermistor after 5 minutes of compressor startup.	
6		Lit	6 times	Zero cross detecting circuit (Outdoor control P.C. board)	Zero cross signal cannot be detected.	<ul style="list-style-type: none"> Replace the outdoor control P.C. board.
7		Lit	7 times	Outdoor control system	The nonvolatile memory data cannot be read properly.	<ul style="list-style-type: none"> Replace the outdoor control P.C. board.
8		Lit	8 times	Current sensor	Current sensor protection cut-out operates 2 consecutive times.	<ul style="list-style-type: none"> Replace the outdoor power P.C. board.
9		Lit	11 times	Communication error between P.C. boards	The communication protection cut-out between boards operates 2 consecutive times.	<ul style="list-style-type: none"> Check the connecting wire between outdoor control P.C. board and outdoor power P.C. board.
				M-NET communication error	M-NET adapter P.C. board detects an abnormality in the communication error.	<ul style="list-style-type: none"> Check the connecting wire between M-NET adapter P.C. board and outdoor control P.C. board, or terminal block.
10	Lit	12 times	Zero cross detecting circuit (Outdoor power P.C. board)	The protection cut-out of the zero cross detecting circuit operates 10 consecutive times.	<ul style="list-style-type: none"> Replace the outdoor power P.C. board. 	
11	Lit	13 times	Current sensor	A short or open circuit is detected in the input current detection circuit during operation.	<ul style="list-style-type: none"> Replace the outdoor power P.C. board. 	
12	Lit	14 times	Voltage sensor	A short or open circuit is detected in the input voltage detection circuit during operation.	<ul style="list-style-type: none"> Replace the outdoor power P.C. board. 	
13	Lit	15 times	Relay operation	No relay operation is detected during operation.	<ul style="list-style-type: none"> Replace the outdoor power P.C. board. 	
14	'Outdoor unit stops and restarts 3 minutes later' is repeated.	Twice	Not lit	IPM protection	Overcurrent is detected after 30 seconds of compressor startup.	<ul style="list-style-type: none"> Reconnect compressor connector. Refer to 12-6. ㉕ "How to check inverter/compressor". Check the stop valve. Check the power module (PAM module).
				Lock protection	Overcurrent is detected within 30 seconds of compressor startup.	
15		3 times	Not lit	Discharge temperature protection	The discharge temperature exceeds 115°C during operation. Compressor can restart if discharge temperature thermistor reads 80°C or less 3 minutes later.	<ul style="list-style-type: none"> Check the amount of gas and refrigerant circuit. Refer to 12-6. ㉔ "Check of LEV".
16		4 times	Not lit	Fin temperature protection	The fin temperature exceeds during operation.	<ul style="list-style-type: none"> Check refrigerant circuit and refrigerant amount. Refer to 12-6. ㉗ "Check of outdoor fan motor".
				P.C. board temperature protection	The P.C. board temperature exceeds during operation.	
17		5 times	Not lit	High pressure protection	High pressure is detected with the high pressure switch (HPS) during operation.	<ul style="list-style-type: none"> Check around of gas and the refrigerant circuit. Check the stop valve.
					The outdoor heat exchanger temperature exceeds 70°C during cooling or the indoor gas pipe temperature exceeds 70°C during heating.	
18		6 times	Not lit	Pre-heating protection	Overcurrent is detected during pre-heating.	<ul style="list-style-type: none"> Reconnect compressor connector. Refer to 12-6. ㉕ "How to check inverter/compressor". Check the power module.
19		8 times	Not lit	Converter protection	A failure is detected in the operation of the converter during operation.	<ul style="list-style-type: none"> Replace the outdoor power P.C. board.
20		9 times	Not lit	Bus-bar voltage protection	The bus-bar voltage exceeds 400 V or falls to low level during compressor operating.	<ul style="list-style-type: none"> Check the voltage of power supply. Replace the outdoor power P.C. board or the outdoor control P.C. board. Refer to 12-6. ㉘ "Check of bus-bar voltage".
21	11 times	Not lit	Low outside temperature protection (cooling)	The ambient became -12°C or less.	—	



No.	Symptom	Indication		Abnormal point / Condition	Condition	Remedy	
		LED1(Red)	LED2(Yellow)				
22	Outdoor unit stops and restarts 3 minutes later' is repeated.	13 times	Not lit	Outdoor fan motor	A failure occurs 3 consecutive times within 30 seconds after the fan gets started.	• Refer to 12-6. Ⓒ "Check of outdoor fan motor".	
23		Lit	8 times	Current sensor protection	A short or open circuit is detected in the current sensor during compressor operating.	• Replace the outdoor power P.C. board.	
24		Lit	11 times	Communication between P.C. boards protection	Communication error occurs between the outdoor control P.C. board and outdoor power P.C. board for more than 10 seconds.	• Check the connecting wire between outdoor control P.C. board and outdoor power P.C. board.	
25		Lit	12 times	Zero cross detecting circuit (Outdoor power P.C. board)	Zero cross signal cannot be detected while the compressor is operating.	• Replace the outdoor power P.C. board.	
26	Outdoor unit operates.	Once	Lit	Primary current protection	The input current exceeds 13.6 A.	These symptoms do not mean any abnormality of the product, but check the following points. • Check if indoor filters are clogged. • Check if refrigerant is short. • Check if indoor/outdoor unit air circulation is short cycled.	
27		Twice	Lit	High pressure protection	The indoor gas pipe temperature exceeds 45°C during heating.		
				Defrosting in cooling	The indoor gas pipe temperature falls 3°C or below during cooling.		
28		3 times	Lit	Discharge temperature protection	The frequency of the compressor is kept 80 Hz or more and the discharge temperature is kept under 50°C(COOL mode)/40°C(HEAT mode) for more than 40 minutes.		• Check refrigerant circuit and refrigerant amount. • Refer to 12-6. Ⓒ "Check of LEV". • Refer to 12-6. Ⓓ "Check of outdoor thermistors".
29		4 times	Lit	Low discharge temperature protection	The frequency of the compressor is kept 80 Hz or more and the discharge temperature is kept under 39°C for more than 20 minutes.		• Refer to 12-6. Ⓒ "Check of LEV". • Check refrigerant circuit and refrigerant amount.
30		5 times	Lit	Cooling high pressure protection	The outdoor heat exchanger temperature exceeds 58°C during operation.		This symptom does not mean any abnormality of the product, but check the following points. • Check if indoor filters are clogged. • Check if refrigerant is short. • Check if indoor/outdoor unit air circulation is short cycled.
31	7 times	Lit	High → Low Pressure bypass valve Cooling evaporating temperature drop prevention control	During cooling operation, the temperature of indoor heat exchanger becomes 3°C or less within 1 hour after the compressor starts running, or it becomes less than 12°C - 16°C* later than that. * It depends on the difference between the set temperature and the room temperature.	This symptom does not mean any abnormality of the product, but check the following points. • Check the indoor filters are not clogged. • Check there is sufficient refrigerant. • Check the indoor/outdoor unit air circulation is not short cycled.		
32	11 times	Lit	M-NET communication error	M-NET adapter P.C. board detects an abnormality in the communication error.	• Check the connecting wire between M-NET adapter P.C. board and outdoor control P.C. board, or terminal block.		
33	Outdoor unit operates normally.	8 times	Lit	Cooling evaporating temperature protection	During cooling operation, the temperature of indoor heat exchanger becomes 7°C - 11°C* or less within 1 hour after the compressor starts running, or it becomes 9°C - 17°C* or less later than that. * It depends on the indoor unit type/model or the difference between the set temperature and the room temperature.	This symptom does not mean any abnormality of the product.	
34		9 times	Lit	Inverter check mode	The unit is operated with emergency operation switch.	—	
35		Lit	Lit	Normal	—	—	

NOTE 1. The location of LED is illustrated at the right figure. Refer to 12-7.1.
 2. LED is lit during normal operation.
 The blinking frequency shows the number of times the LED blinks after every 2.5-second OFF.
 (Example) When the blinking frequency is "2".

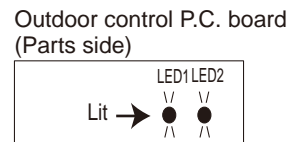
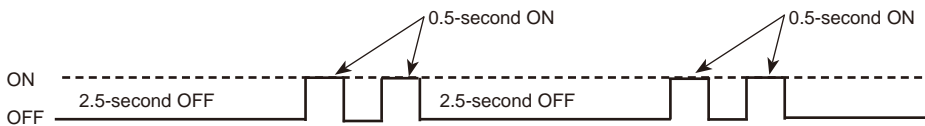

12-5. TROUBLE CRITERION OF MAIN PARTS

MXZ-2HA40VF MXZ-2HA50VF MXZ-3HA50VF

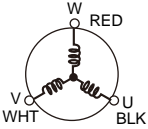
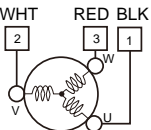
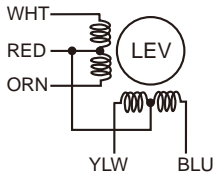
Part name	Check method and criterion								
Defrost thermistor (RT61) Fin temperature thermistor (RT64) Ambient temperature thermistor (RT65) Outdoor heat exchanger temperature thermistor (RT68)	Measure the resistance with a tester. Refer to 12-7. "TEST POINT DIAGRAM AND VOLTAGE" 1. "Inverter P.C. board", 2. "Outdoor control P.C. board " or 3. "Outdoor power P.C. board" for the chart of thermistor.								
Discharge temperature thermistor (RT62)	Measure the resistance with a tester. Before measurement, hold the thermistor with your hands to warm it up. Refer to 12-7. "TEST POINT DIAGRAM AND VOLTAGE" 1. "Inverter P.C. board", 2. "Outdoor control P.C. board ", for the chart of thermistor.								
Compressor 	Measure the resistance between terminals with a tester. (Winding temperature : -10°C - 40°C) <table border="1" style="margin-left: auto; margin-right: auto;"> <tr> <td>Normal (Each phase)</td> </tr> <tr> <td style="text-align: center;">0.86 Ω - 1.06 Ω</td> </tr> </table>	Normal (Each phase)	0.86 Ω - 1.06 Ω						
Normal (Each phase)									
0.86 Ω - 1.06 Ω									
Outdoor fan motor  MXZ-2HA40VF/2HA50VF	Measure the resistance between lead wires with a tester. (Part temperature : -10°C - 40°C) <table border="1" style="margin-left: auto; margin-right: auto;"> <tr> <td>Normal (Each phase)</td> </tr> <tr> <td style="text-align: center;">32 Ω - 43 Ω</td> </tr> </table>	Normal (Each phase)	32 Ω - 43 Ω						
Normal (Each phase)									
32 Ω - 43 Ω									
Outdoor fan motor MXZ-3HA50VF	Refer to 12-6. ㉔.								
R.V. coil	Measure the resistance with a tester. (Part temperature : -10°C - 40°C) <table border="1" style="margin-left: auto; margin-right: auto;"> <tr> <td colspan="2" style="text-align: center;">Normal</td> </tr> <tr> <td style="text-align: center;">MXZ-2HA40VF MXZ-2HA50VF</td> <td style="text-align: center;">MXZ-3HA50VF</td> </tr> <tr> <td style="text-align: center;">1.2 kΩ - 1.56 kΩ</td> <td style="text-align: center;">1.26 kΩ - 1.62 kΩ</td> </tr> </table>	Normal		MXZ-2HA40VF MXZ-2HA50VF	MXZ-3HA50VF	1.2 kΩ - 1.56 kΩ	1.26 kΩ - 1.62 kΩ		
Normal									
MXZ-2HA40VF MXZ-2HA50VF	MXZ-3HA50VF								
1.2 kΩ - 1.56 kΩ	1.26 kΩ - 1.62 kΩ								
Linear expansion valve 	Measure the resistance with a tester. (Part temperature : -10°C - 40°C) <table border="1" style="margin-left: auto; margin-right: auto;"> <tr> <td>Color of lead wire</td> <td>Normal</td> </tr> <tr> <td>WHT - RED</td> <td rowspan="4" style="text-align: center; vertical-align: middle;">37.4 Ω - 53.9 Ω</td> </tr> <tr> <td>RED - ORN</td> </tr> <tr> <td>YLW - RED</td> </tr> <tr> <td>RED - BLU</td> </tr> </table>	Color of lead wire	Normal	WHT - RED	37.4 Ω - 53.9 Ω	RED - ORN	YLW - RED	RED - BLU	
Color of lead wire	Normal								
WHT - RED	37.4 Ω - 53.9 Ω								
RED - ORN									
YLW - RED									
RED - BLU									
High pressure switch (HPS) MXZ-3HA50VF	<table border="1" style="margin-left: auto; margin-right: auto;"> <tr> <td></td> <td>Pressure</td> <td>Normal</td> </tr> <tr> <td rowspan="2" style="text-align: center;">HPS</td> <td style="text-align: center;">3.43 ± 0.15 MPa</td> <td style="text-align: center;">Close</td> </tr> <tr> <td style="text-align: center;">4.14 ± 0.1 MPa</td> <td style="text-align: center;">Open</td> </tr> </table>		Pressure	Normal	HPS	3.43 ± 0.15 MPa	Close	4.14 ± 0.1 MPa	Open
	Pressure	Normal							
HPS	3.43 ± 0.15 MPa	Close							
	4.14 ± 0.1 MPa	Open							

12-6. TROUBLESHOOTING FLOW

Outdoor unit does not operate.

Ⓐ Check of power supply

MXZ-2HA40VF/2HA50VF

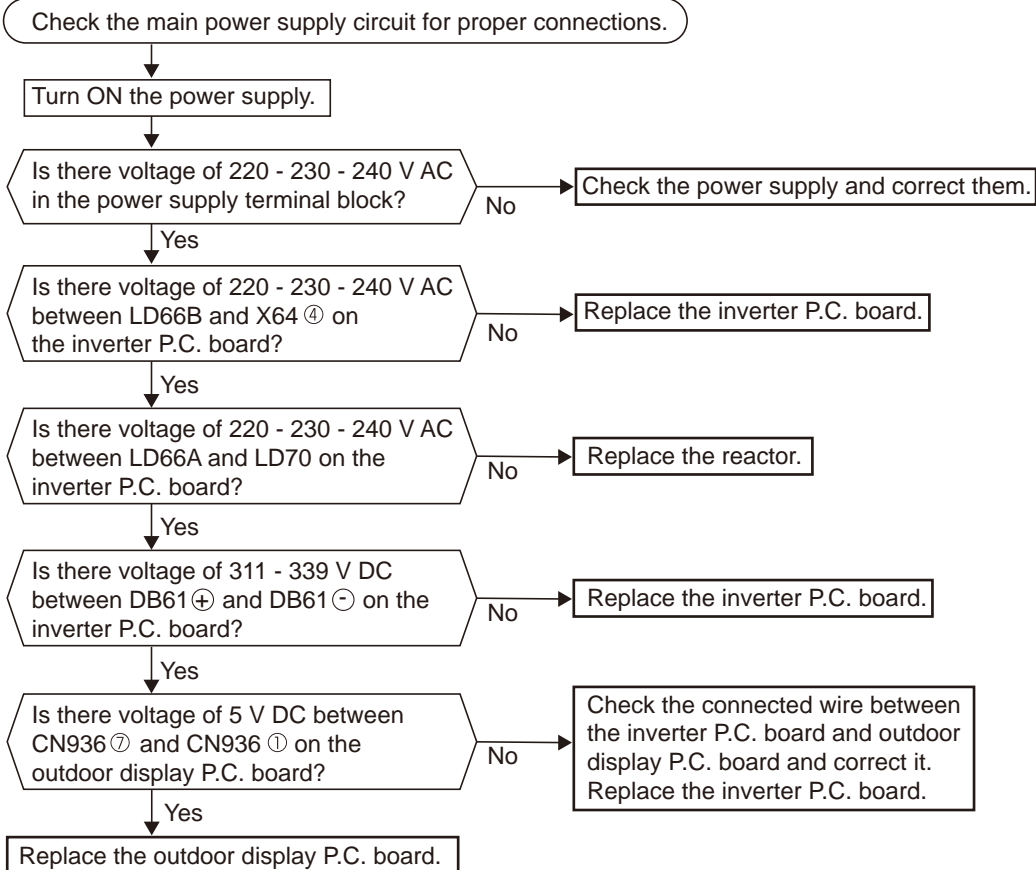

MXZ-3HA50VF

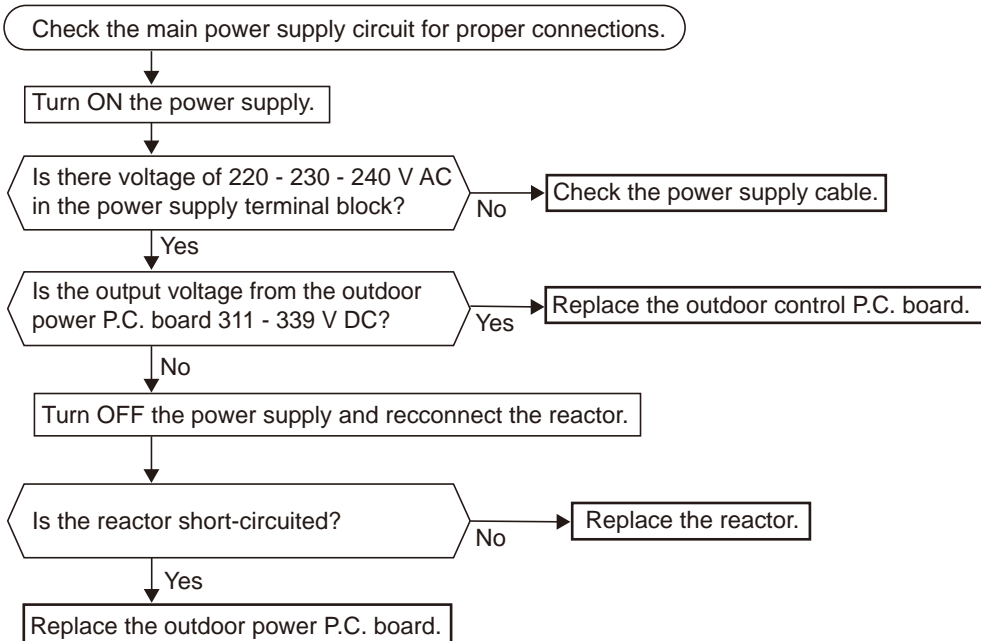

- When the indoor unit does not operate, it cannot be operated either with the remote controller or with the emergency operation switch.
- When the outdoor unit does not operate, the OPERATION INDICATOR lamp on the indoor unit blinks ON and OFF every 0.5-second.

⑧ How to check miswiring and serial signal error (when outdoor unit does not work)

MXZ-2HA40VF/2HA50VF

LED indication for communication status

Communication status is indicated by the LED.

Unit status

Blinking: normal communication
 Lit: abnormal communication or not connected
 Not lit: The outdoor P.C. board is abnormal.

Outdoor display P.C. board
 LED1 LED2

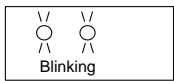

LED 1	LED 2
Unit A status	Unit B status

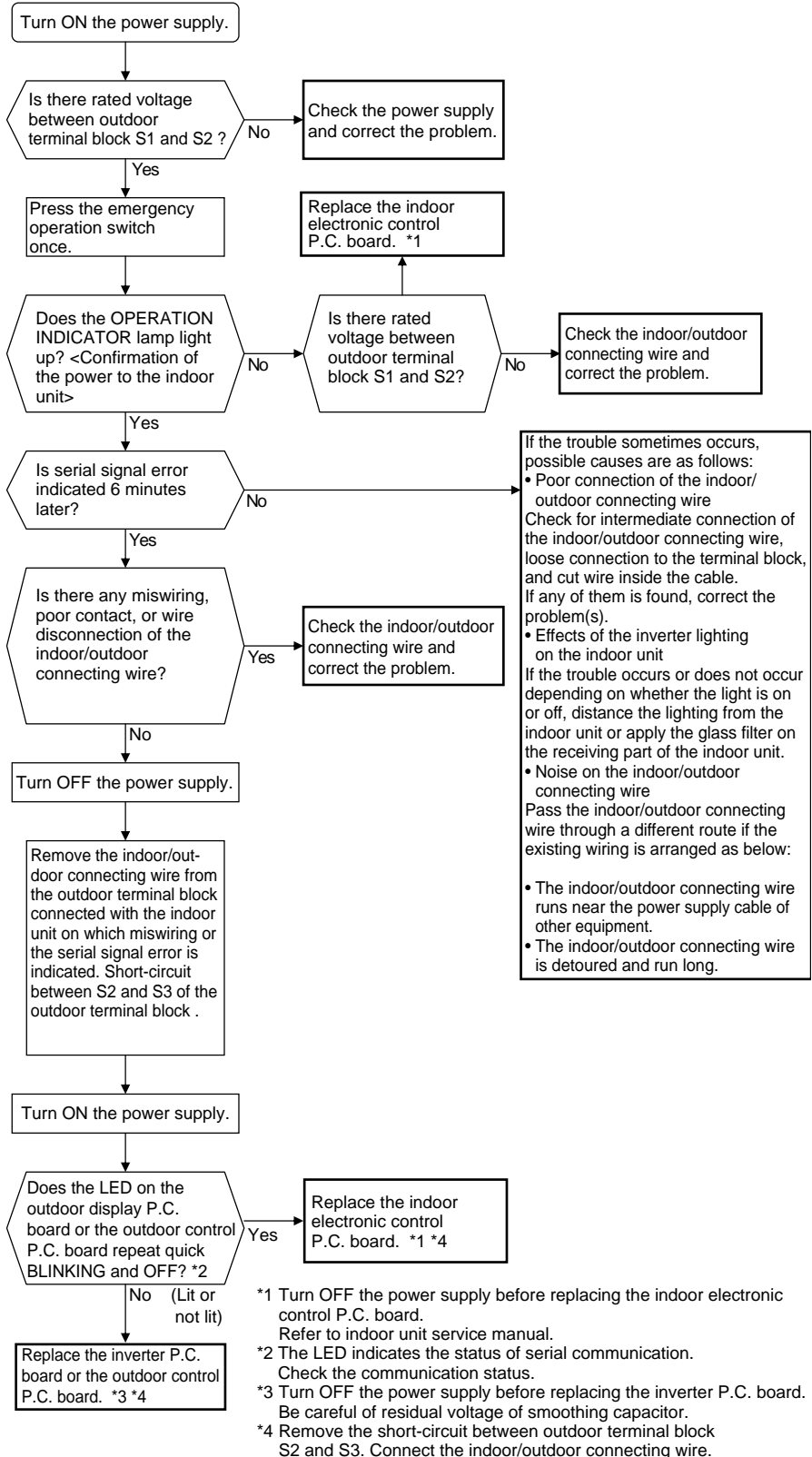

MXZ-3HA50VF

LED indication for communication status
 Communication status is indicated by the LED.

Unit status
 Blinking: normal communication
 Lit: abnormal communication or not connected

Pattern 1 and 2 is repeatedly displayed alternately. Each pattern is displayed for 10 seconds.

NOTE: "Lit" in the table below does not indicate abnormal communication.

Outdoor control P.C. board

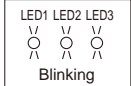

Pattern	LED 1	LED 2	LED 3
1	Unit A status	Unit B status	Lit
2	Unit C status	Unit D status	Not lit

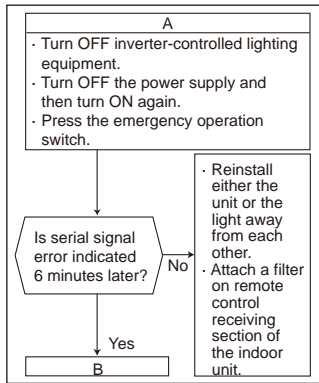
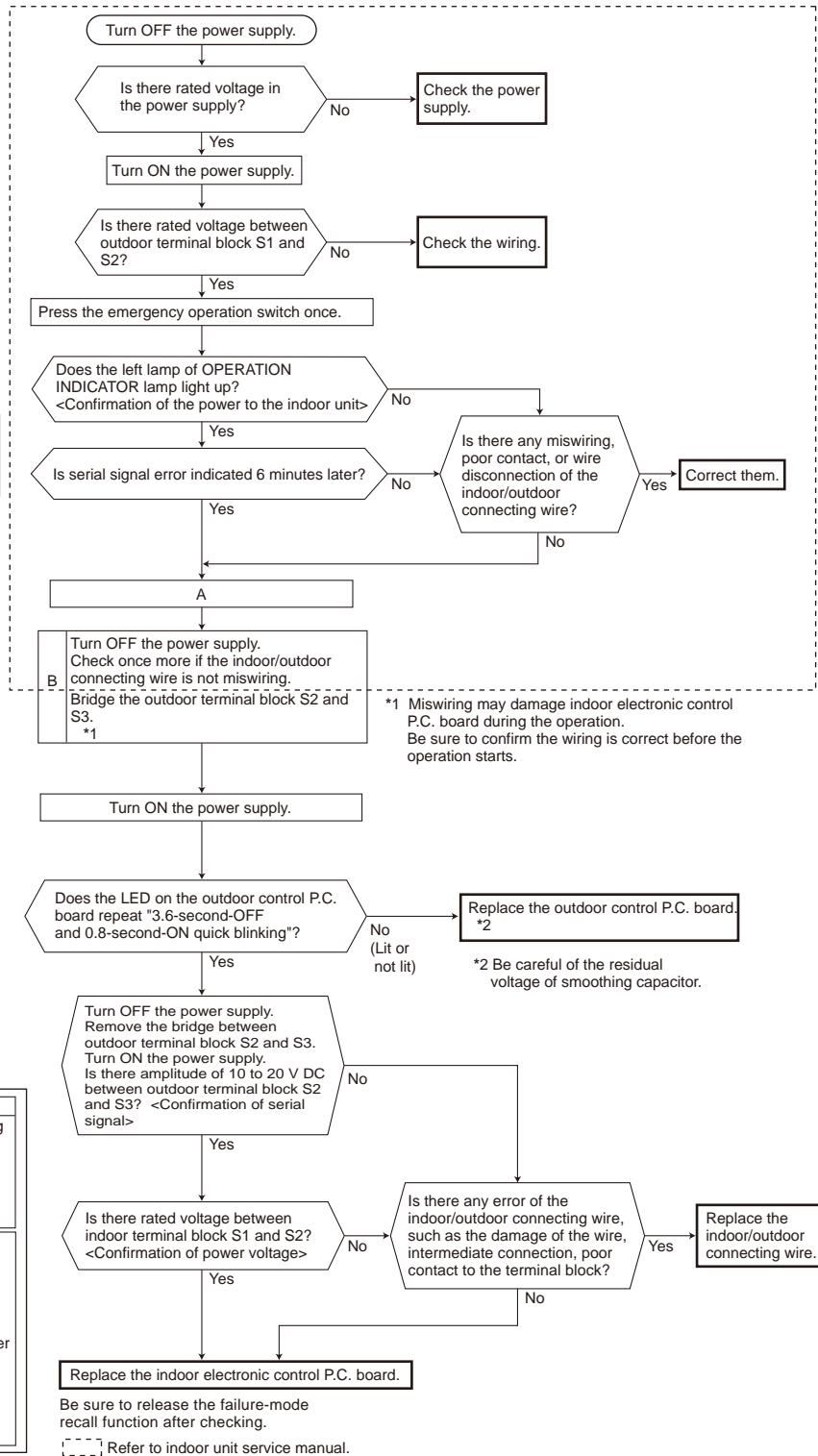

The cooling operation or heating operation does not operate.

© Check of R.V. coil

MXZ-2HA40VF/2HA50VF

Connector	MXZ-2HA
CN721	Inverter P.C. board

• The heating operation does not operate.

1. Disconnect the lead wire leading to the compressor.
2. 3 minutes after turning ON the power supply, start EMERGENCY OPERATION in HEAT mode.

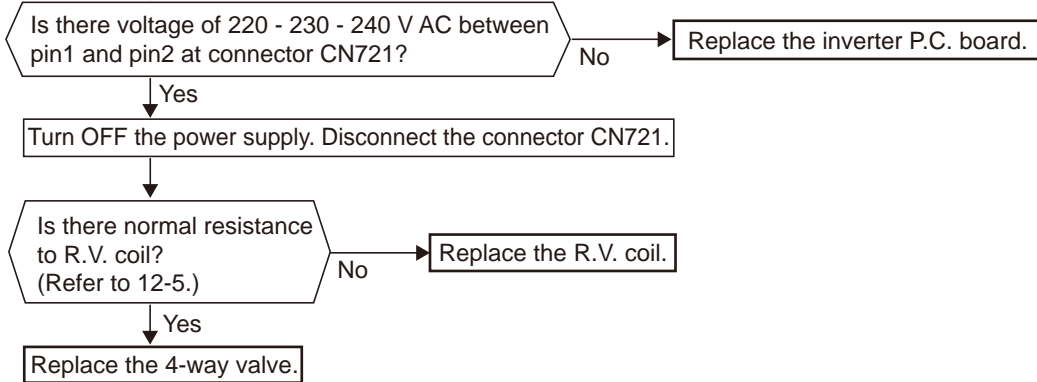

• The cooling operation does not operate.

1. Disconnect the lead wire leading to the compressor.
2. 3 minutes after turning ON the power supply, start EMERGENCY OPERATION in COOL mode.

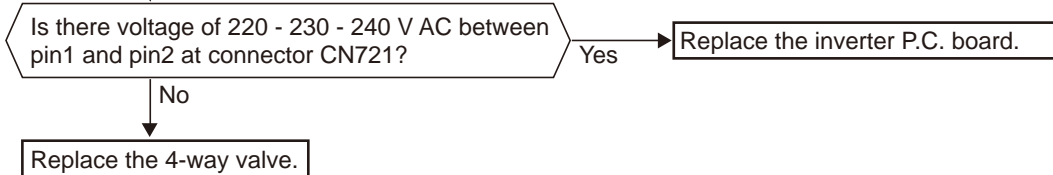

MXZ-3HA50VF

Connector	MXZ-3HA
CNAC CN712	Outdoor control P.C. board
CNAC2	Outdoor power P.C. board

• When cooling operation does not work.

1. Disconnect the lead wire leading to the compressor.
2. 3 minutes after turning ON the power supply, start EMERGENCY OPERATION in COOL mode.

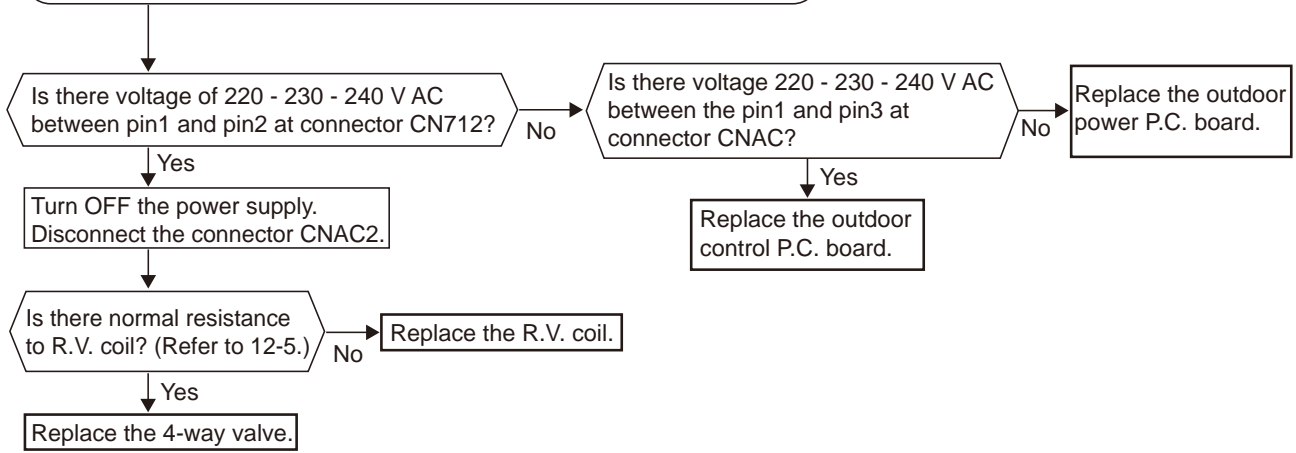

• When heating operation does not work.

1. Disconnect the lead wire leading to the compressor.
2. 3 minutes after turning ON the power supply, start EMERGENCY OPERATION in HEAT mode.

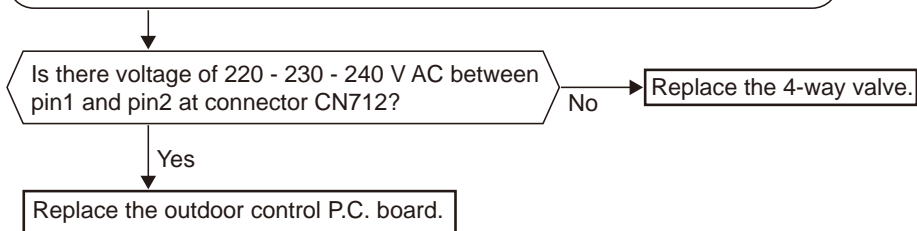



- When cooling, heat exchanger of non-operating indoor unit frosts.
- When heating, non-operating indoor unit gets warm.

⑩ Check of LEV

Connector	MXZ-2HA	MXZ-3HA
CN724 CN725	Inverter P.C. board	Outdoor control P.C. board
CN791 CN792 CN793 CN794 CN795 CN796	—	

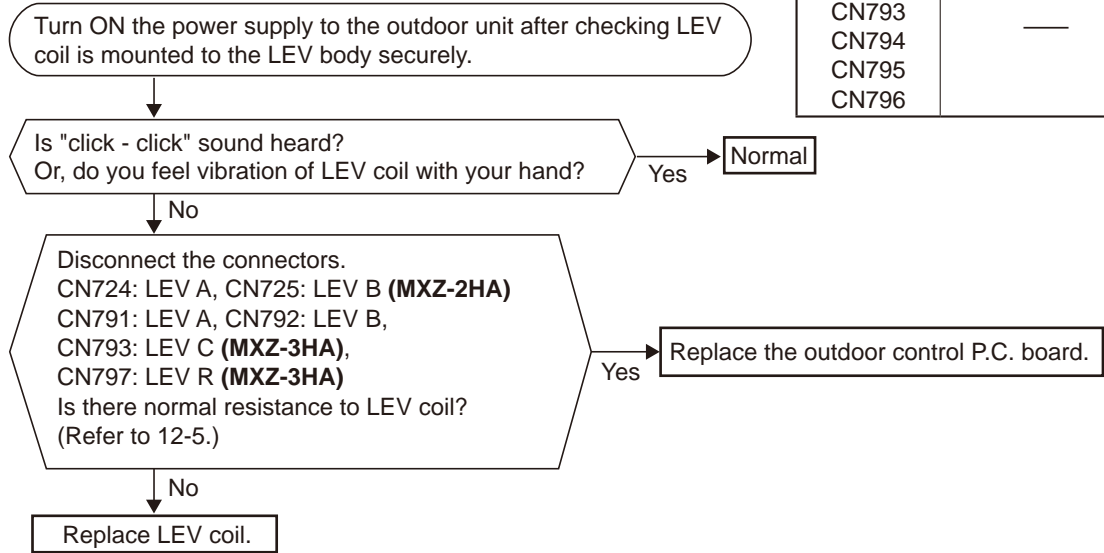

- When heating, room does not get warm.
- When cooling, room does not get cool.

⑤ How to check inverter/compressor

Disconnect the terminal of the compressor or the connector (CNMC) between the compressor and the outdoor power P.C. board. 3 minutes after the power supply is turned ON, start EMERGENCY OPERATION.

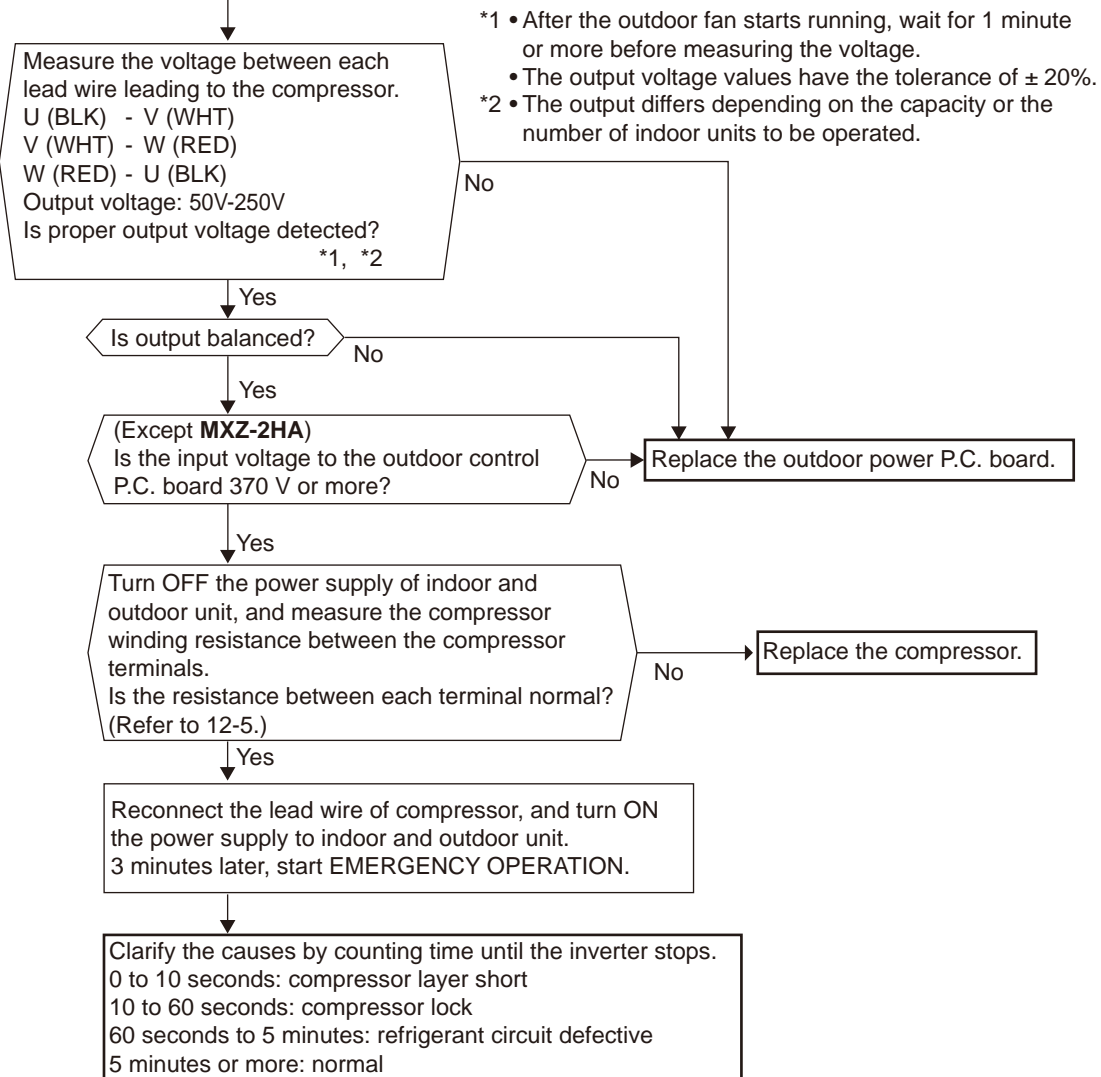

• When thermistor is abnormal.

⑤ Check of outdoor thermistors

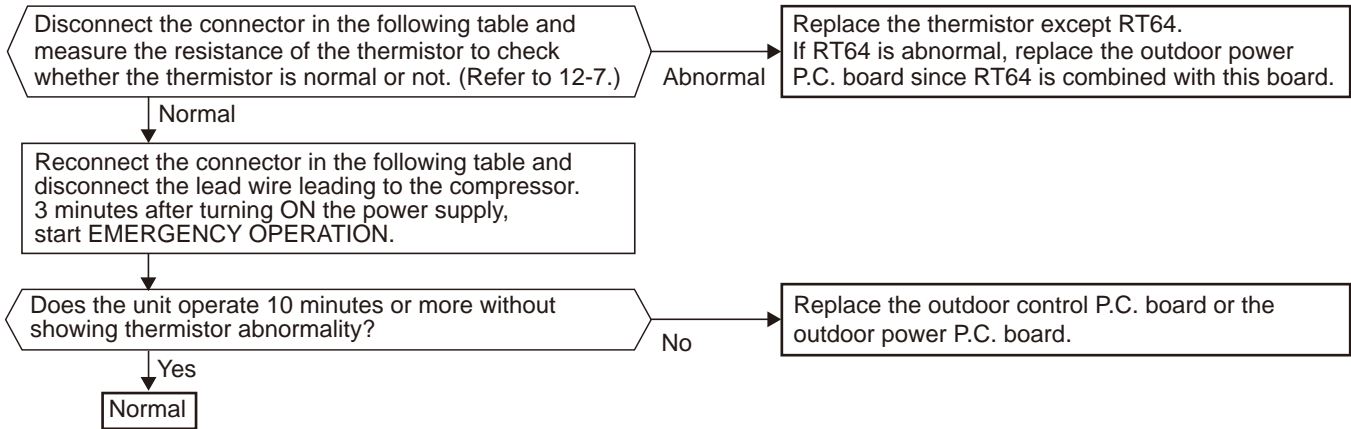

MXZ-2HA40VF
MXZ-2HA50VF

Thermistor	Symbol	Connector, Pin No.	Board
Defrost	RT61	CN641 pin1 and pin2	Inverter P.C. board
Discharge temperature	RT62	CN641 pin3 and pin4	
Fin temperature	RT64	CN642 pin1 and pin2	
Ambient temperature	RT65	CN643 pin1 and pin2	
Outdoor heat exchanger temperature	RT68	CN644 pin1 and pin3	

MXZ-3HA50VF

Thermistor	Symbol	Connector, Pin No.	Board
Defrost	RT61	Between CNTH1 pin1 and pin2	Outdoor control P.C. board
Discharge temperature	RT62	Between CNTH1 pin3 and pin4	
Outdoor heat exchanger temperature	RT68	Between CNTH1 pin7 and pin8	
Ambient temperature	RT65	Between CNTH2 pin1 and pin2	Outdoor power P.C. board
Fin temperature	RT64	Between CN171 pin1 and pin2	



• Fan motor does not operate or stops operating shortly after starting the operation.

⑥ Check of outdoor fan motor

MXZ-2HA40VF/2HA50VF

Connector	MXZ-2HA
CN931 CN932	Inverter P.C. board

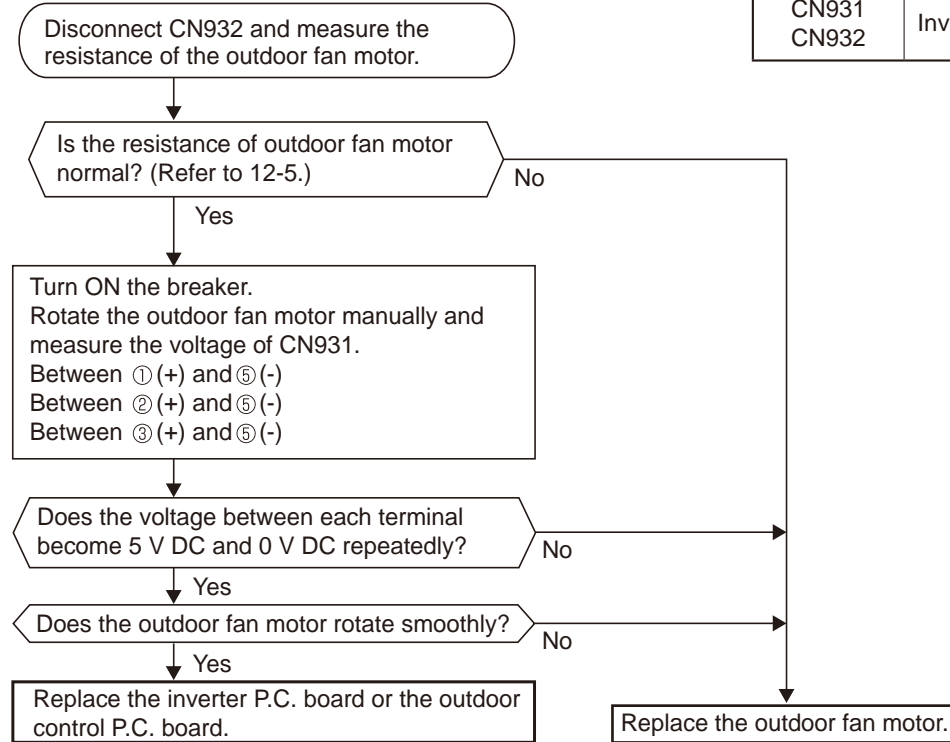

MXZ-3HA50VF

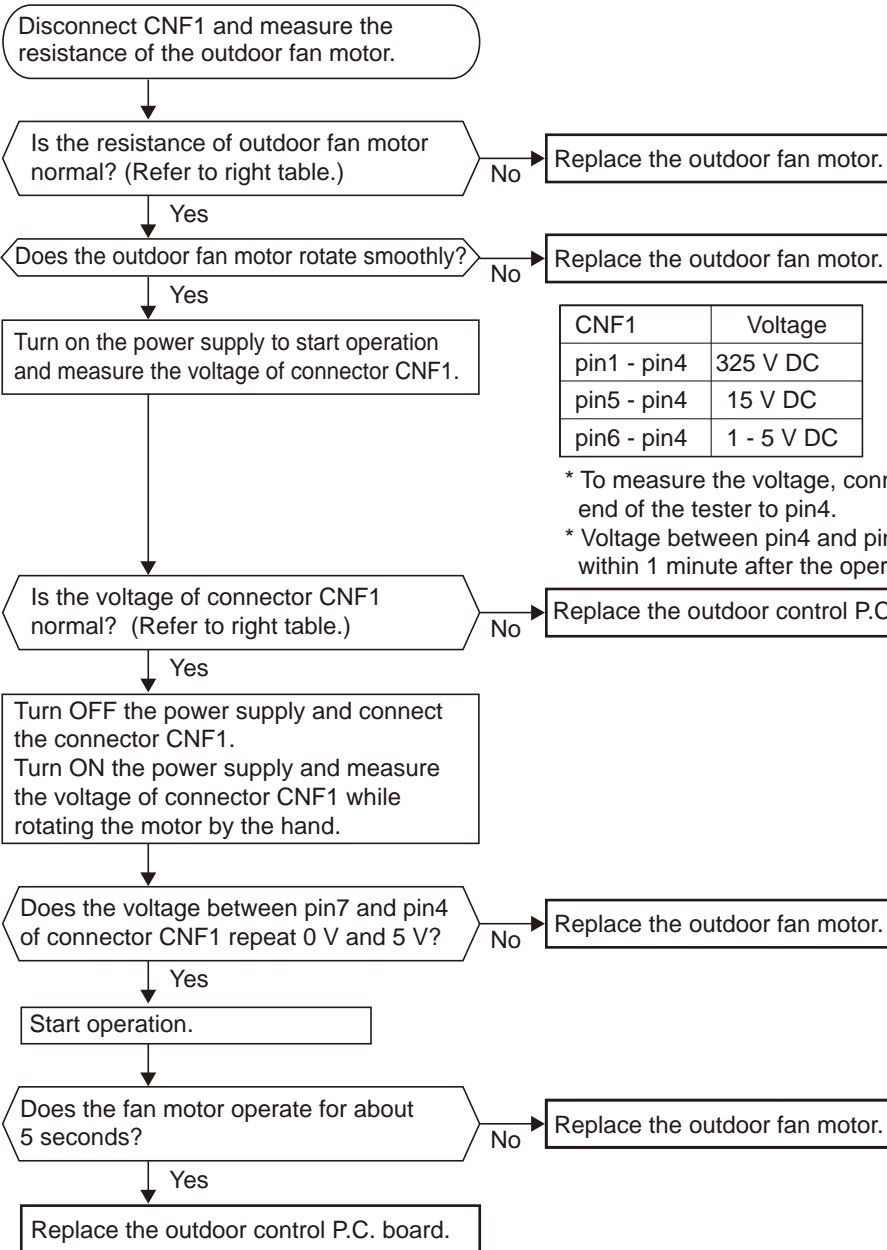

Connector	MXZ-3HA
CNF1	Outdoor control P.C. board

Measuring points	Resistance
pin1 - pin4	∞
pin5 - pin4	60 k Ω
pin6 - pin4	160 k Ω
pin7 - pin4	∞

* To measure the resistance, connect the negative (-) end of the tester to pin4.

CNF1	Voltage
pin1 - pin4	325 V DC
pin5 - pin4	15 V DC
pin6 - pin4	1 - 5 V DC

* To measure the voltage, connect the negative (-) end of the tester to pin4.

* Voltage between pin4 and pin6 should be measured within 1 minute after the operation starts.

• When the operation frequency does not go up from the lowest frequency.

Ⓜ Check of HPS

Connector	MXZ-3HA
CN63H	Outdoor control P.C. board

MXZ-3HA50VF

1. Disconnect the connector CN63H in the outdoor control P.C. board.
2. Check the resistance of HPS after 1 minute has passed since the outdoor unit power supply was turned OFF.

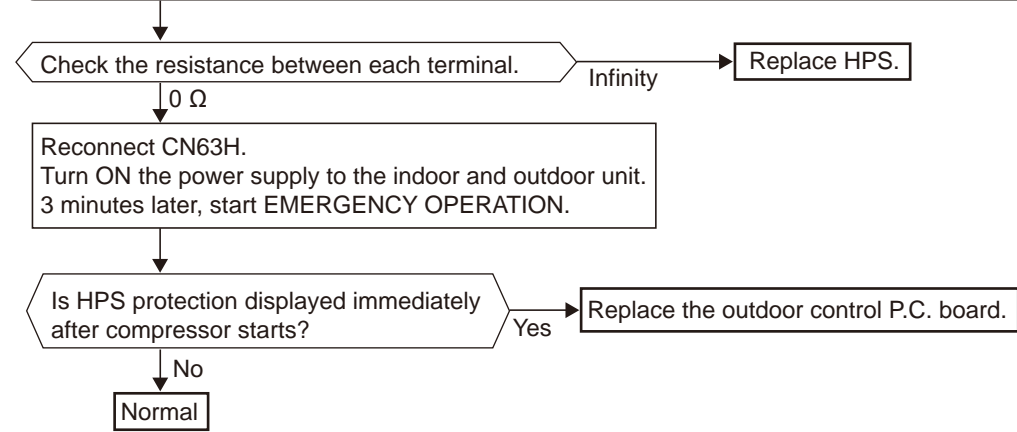

Ⓜ The other cases

- Indoor unit does not operate. (different operating models in multi system)
- When you try to run 2 indoor units simultaneously, one for cooling and the other for heating, the unit which transmits signal to the outdoor units first decides the operation mode.
 - When the above situation occurs, set all the indoor units to the same mode, turn OFF the indoor units, and then turn them back ON.
 - Though the top of the indoor unit sometimes gets warm, this does not mean malfunction. The reason is that the refrigerant gas continuously flows into the indoor unit even while it is not operating.

Ⓜ Check of bus-bar voltage

MXZ-3HA50VF

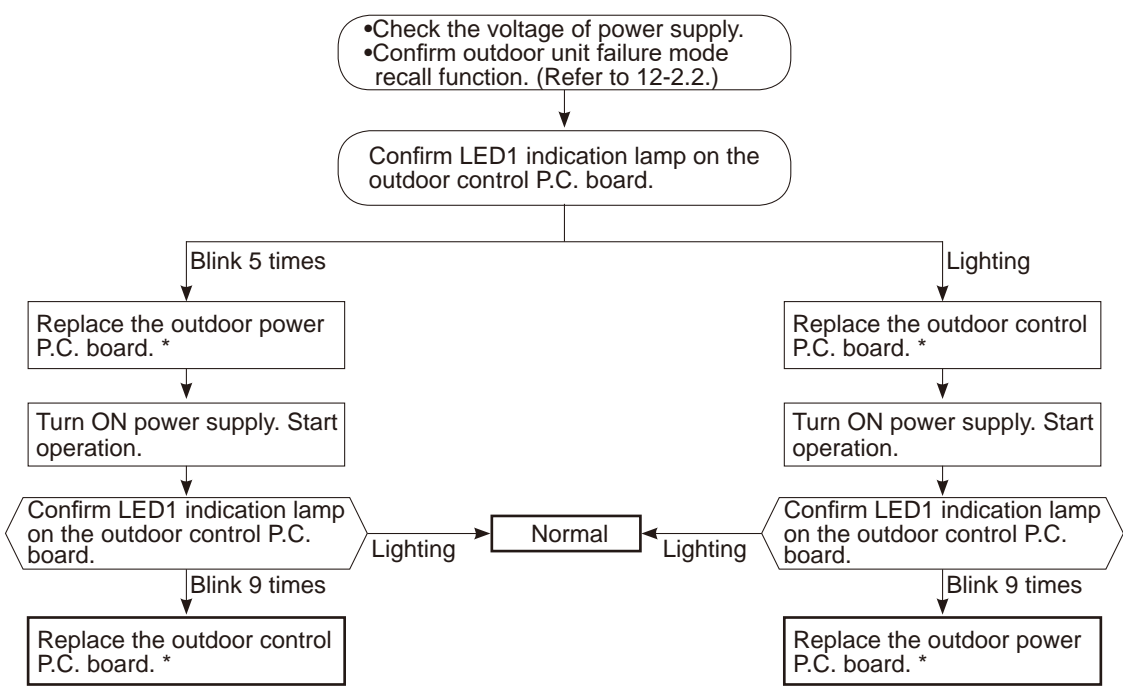

*Turn OFF power supply before removing P.C. board.



⌚ **Check of outdoor refrigerant circuit**

MXZ-2HA40VF/2HA50VF

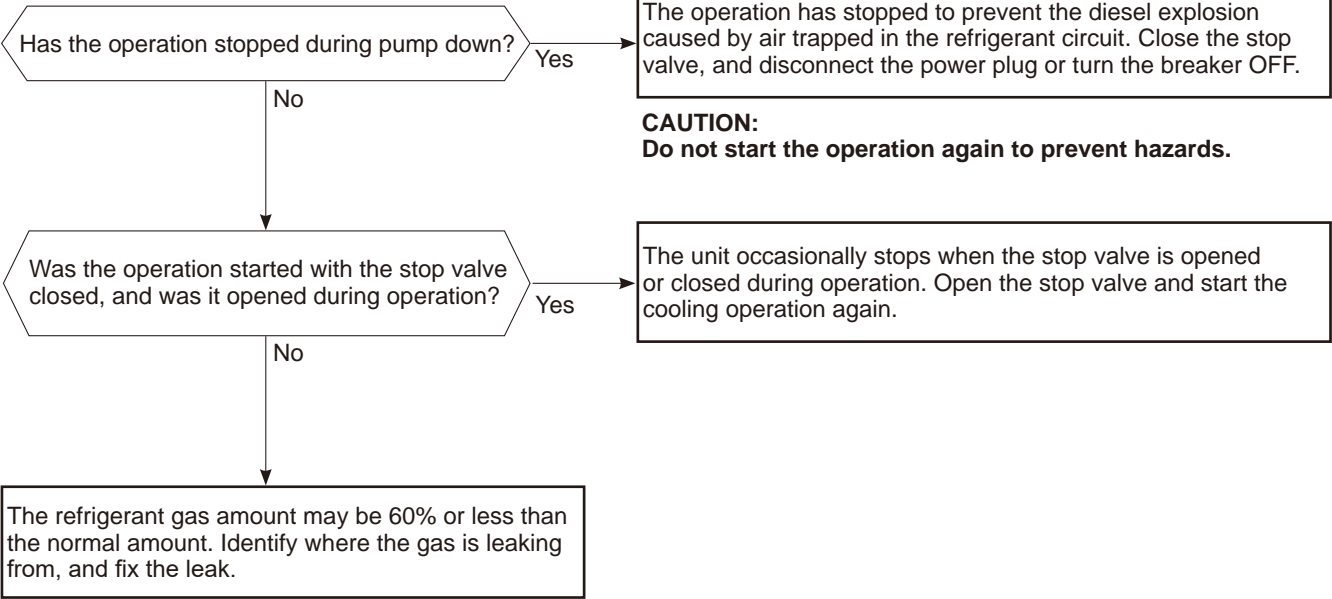

12-7. TEST POINT DIAGRAM AND VOLTAGE

1. Inverter P.C. board

MXZ-2HA40VF MXZ-2HA50VF

Back side of unit

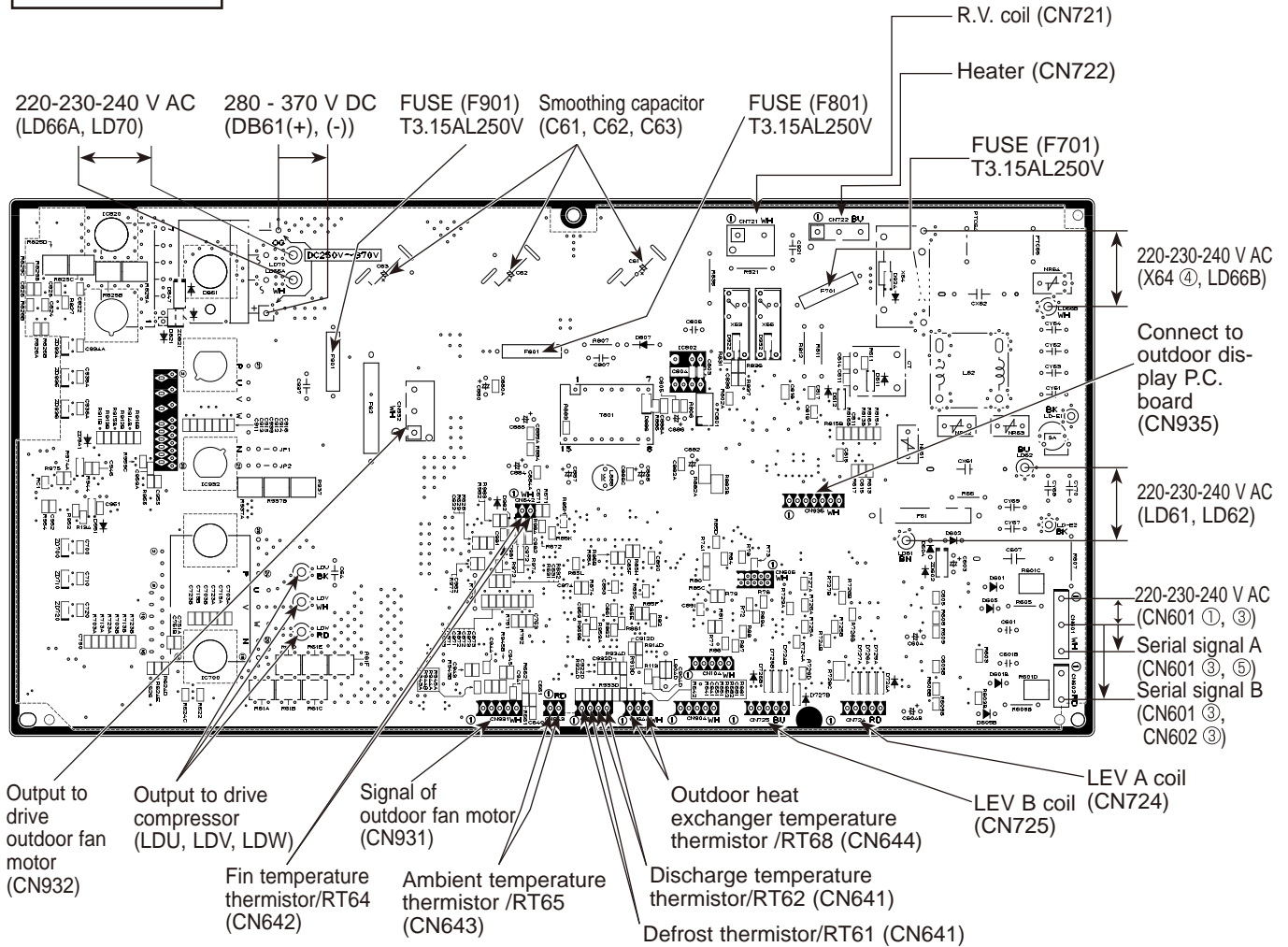

Front side of unit

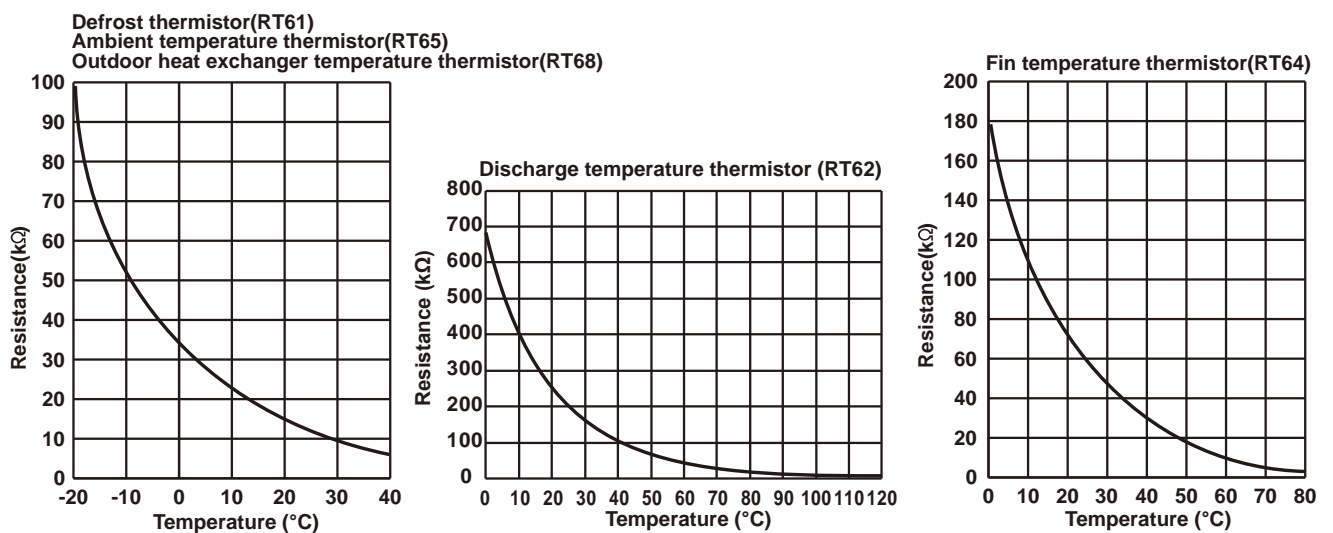

2. Outdoor control P.C. board
MXZ-3HA50VF

Defrost thermistor (RT61)
Ambient temperature thermistor (RT65)
Outdoor heat exchanger temperature thermistor (RT68)

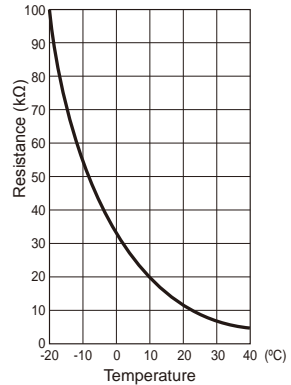
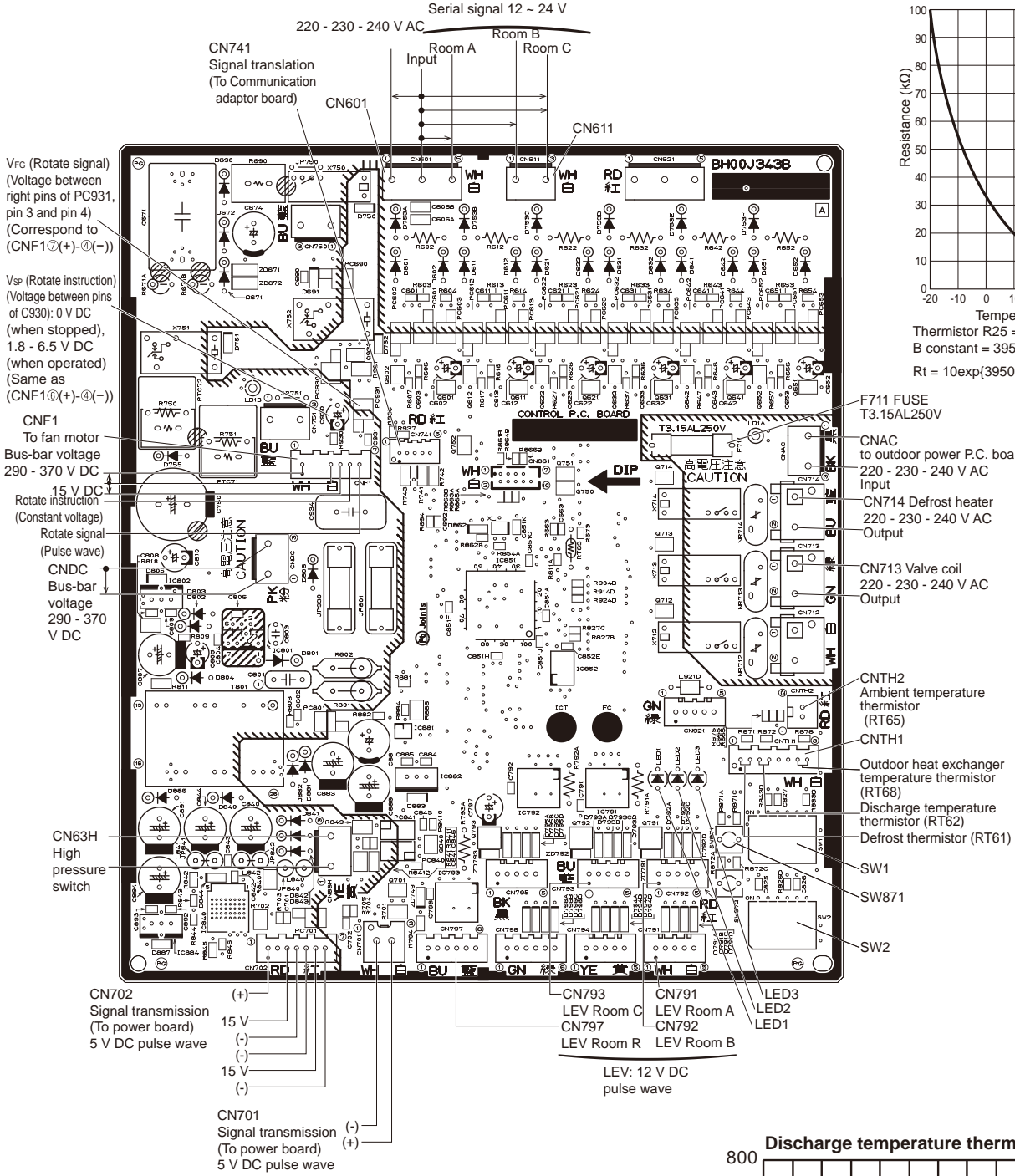

Thermistor R25 = 10 kΩ ± 2%
B constant = 3950 ± 2%

$$R_t = 10 \exp\left\{3950 \left(\frac{1}{273+t} - \frac{1}{298}\right)\right\}$$

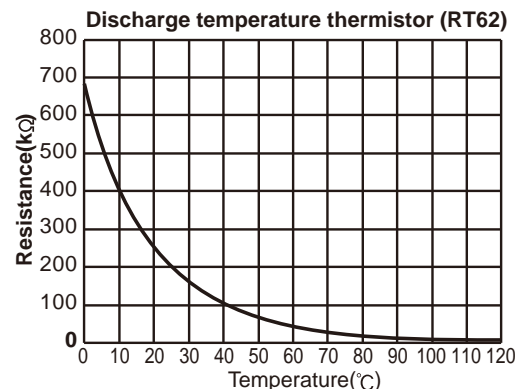

Thermistor R100 = 13.36 kΩ ± 2%

B constant = 4014 ± 2%

$$R_t = 13.36 \exp\left\{4014 \left(\frac{1}{273+t} - \frac{1}{373}\right)\right\}$$

3. Outdoor power P.C. board MXZ-3HA50VF

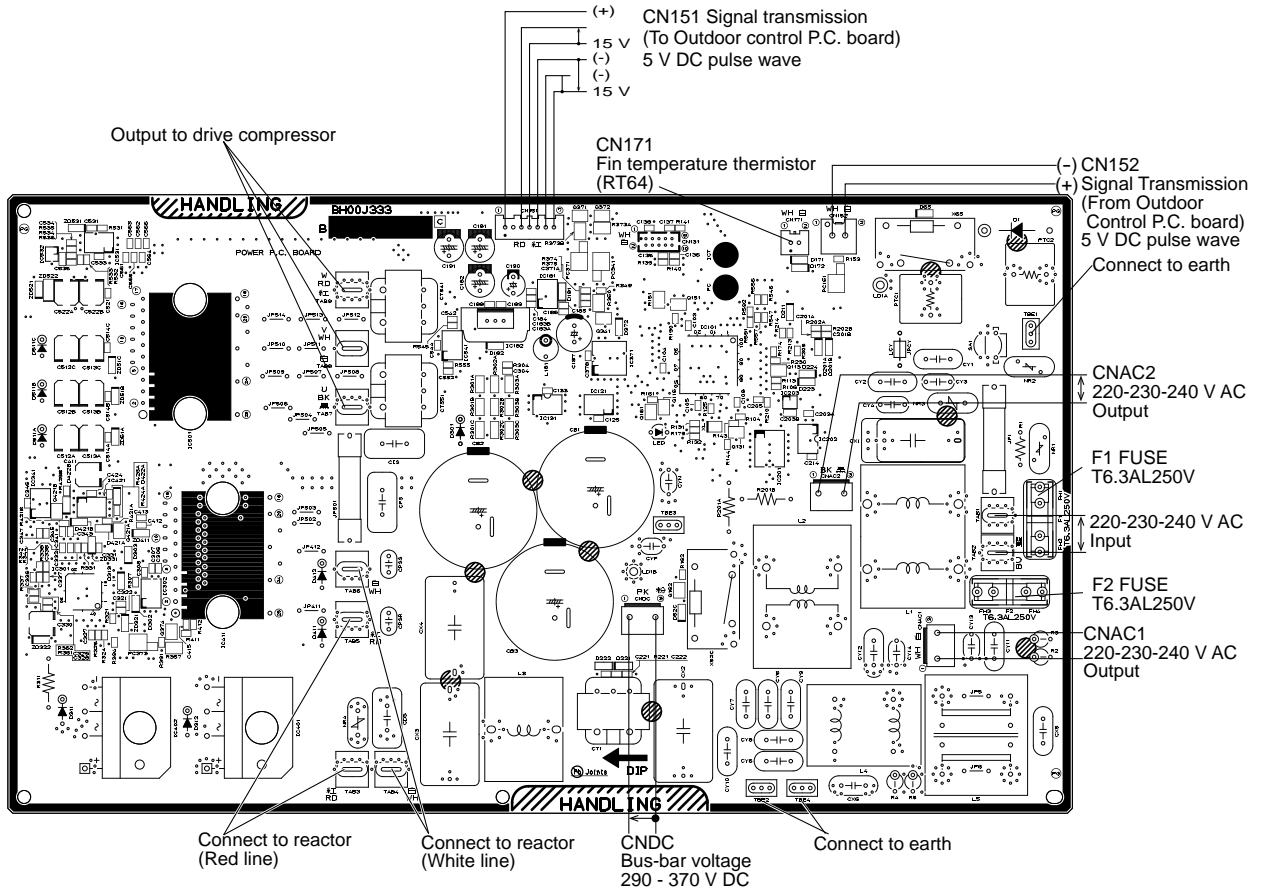

Fin temperature thermistor (RT64)

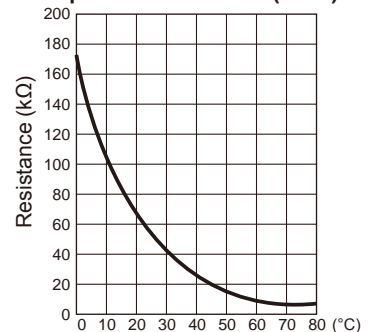

Temperature
Thermistor $R_{50} = 17 \text{ k}\Omega \pm 2\%$
 $B \text{ constant} = 4150 \pm 3\%$
 $R_t = 17 \exp\left\{4150 \left(\frac{1}{273+t} - \frac{1}{323}\right)\right\}$

4. Outdoor display P.C. board MXZ-2HA40VF MXZ-2HA50VF

To inverter P.C. board (CN936)

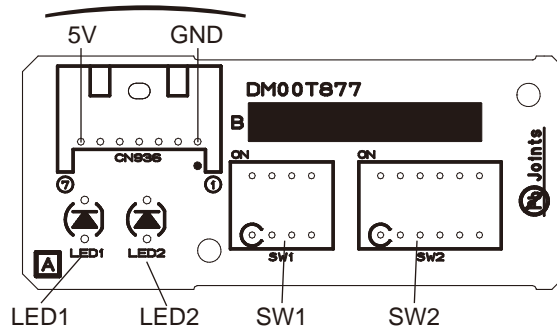

<Detaching method of the terminal with locking mechanism>

The terminal which has the locking mechanism can be detached as shown below.
 There are following 2 types of the terminal with locking mechanism.
 The terminal without locking mechanism can be detached by pulling it out.
 Check the shape of the terminal before detaching.

(1) Slide the sleeve and check if there is a locking lever or not.

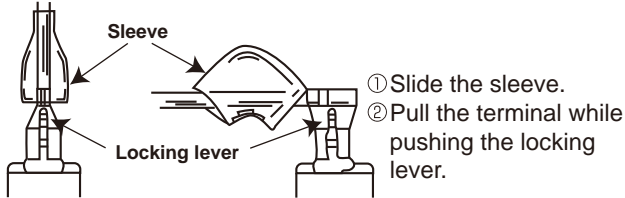

(2) The terminal with the connector shown below has the locking mechanism.

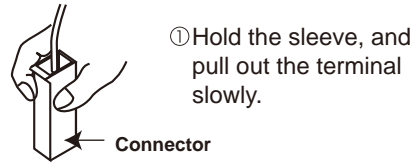

13-1. MXZ-2HA40VF MXZ-2HA50VF

NOTE: Turn OFF the power supply before disassembly.

—→ : Indicates the visible parts in the photos.
 - - -→ : Indicates the invisible parts in the photos.

OPERATING PROCEDURE	PHOTOS
<p>1. Removing the cabinet and the panels</p> <ol style="list-style-type: none"> (1) Remove the screws fixing the service panel. (2) Pull down the service panel and remove it. (3) Disconnect the power supply and indoor/outdoor connecting wire. (4) Remove the screws fixing the top panel. (5) Remove the top panel. (6) Remove the screws fixing the cabinet. (7) Remove the cabinet. (8) Remove the screws fixing the back panel. (9) Remove the back panel. <p>Photo 2</p> <p>Screws of the cabinet Screws of the back panel Screws of the service panel</p>	<p>Photo 1</p> <p>Screws of the top panel Hooks Screws of Service panel Direction to remove</p> <p>Photo 3</p> <p>Screws of the back panel</p>

OPERATING PROCEDURE

2. Removing the inverter assembly and the inverter P.C. board

- (1) Remove the service panel, the top panel and the cabinet (Refer to 1).
- (2) Disconnect the power supply and indoor/outdoor connecting wire and remove the back panel (Refer to section 1).
- (3) Disconnect all connectors and lead wires on the inverter P.C. board.
- (4) Remove the compressor connector (CNMC).
- (5) Remove the screws fixing the heat sink support and the separator.
- (6) Remove the screws of the terminal block support and the back panel. (Photo 2)
- (7) Remove the inverter assembly.
- (8) Remove the screw of the earth wire and screws of the terminal block support.
- (9) Remove the hooks of the heat sink support and remove the heat sink support from the P.C. board support.
- (10) Remove the screw fixing the inverter P.C. board and remove the inverter P.C. board from the P.C. board support.

3. Removing the R.V. coil

- (1) Remove the service panel, the top panel and the cabinet (Refer to section 1).
- (2) Disconnect the power supply and indoor/outdoor connecting wire and remove the back panel (Refer to section 1).
- (3) Remove the inverter assembly (Refer to section 2).
- (4) Remove the R.V. coil.

4. Removing the discharge temperature thermistor, defrost thermistor and outdoor heat exchanger temperature thermistor

- (1) Remove the service panel, the top panel and the cabinet (Refer to section 1).
- (2) Disconnect the power supply and indoor/outdoor connecting wire and remove the back panel (Refer to section 1).
- (3) Remove the inverter assembly (Refer to section 2).
- (4) Pull out the discharge temperature thermistor from its holder.
- (5) Pull out the defrost thermistor from its holder (Photo 7).
- (6) Pull out the outdoor heat exchanger temperature thermistor from its holder (Photo 7).

PHOTOS

Photo 4

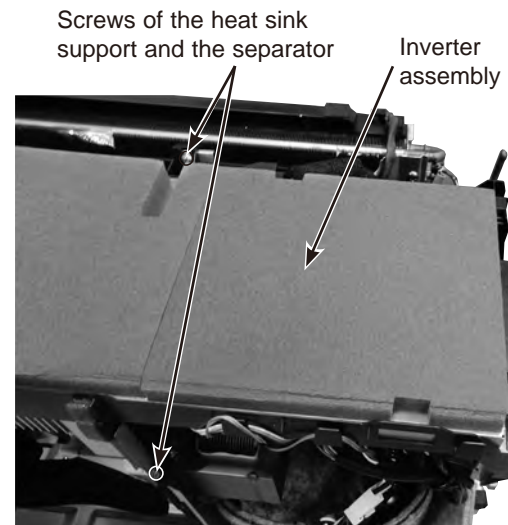

Photo 5

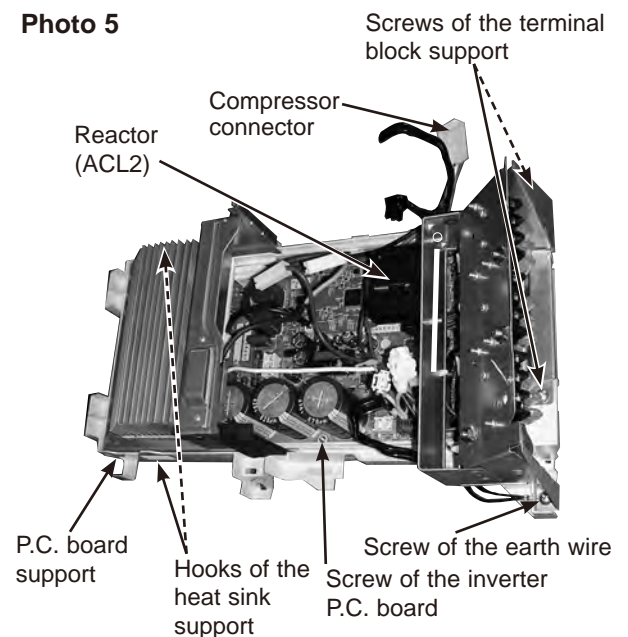
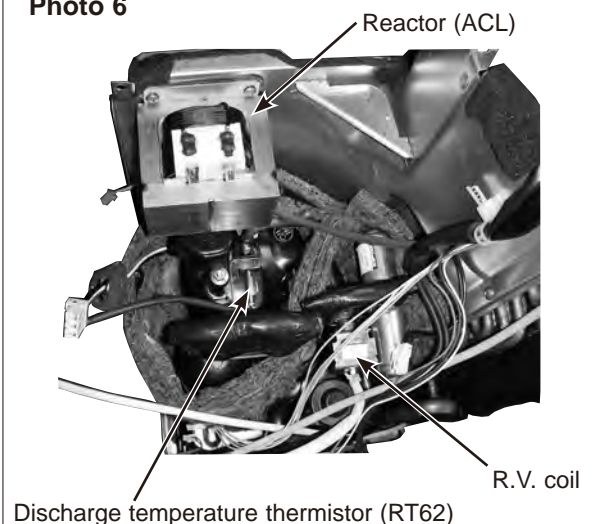

Photo 6



OPERATING PROCEDURE

5. Removing the outdoor fan motor

- (1) Remove the service panel, the top panel and the cabinet (Refer to section 1).
- (2) Disconnect the power supply and indoor/outdoor connecting wire.
- (3) Disconnect the connectors for outdoor fan motor.
- (4) Remove the propeller fan nut.
- (5) Remove the propeller fan.
- (6) Remove the screws fixing the fan motor.
- (7) Remove the fan motor.

6. Removing the compressor and the 4-way valve

- (1) Remove the service panel, the top panel and the cabinet (Refer to section 1).
- (2) Disconnect the power supply and indoor/outdoor connecting wire and remove the back panel (Refer to section 1).
- (3) Remove the inverter assembly (Refer to section 2).
- (4) Recover gas from the refrigerant circuit.

NOTE: Recover gas from the pipes until the pressure gauge shows 0 kg/cm² (0 MPa).

- (5) Detach the brazed part of the suction and the discharge pipe connected with compressor.
- (6) Remove the nuts of compressor legs.
- (7) Remove the compressor.
- (8) Detach the brazed part of pipes connected with 4-way valve.

Photo 10

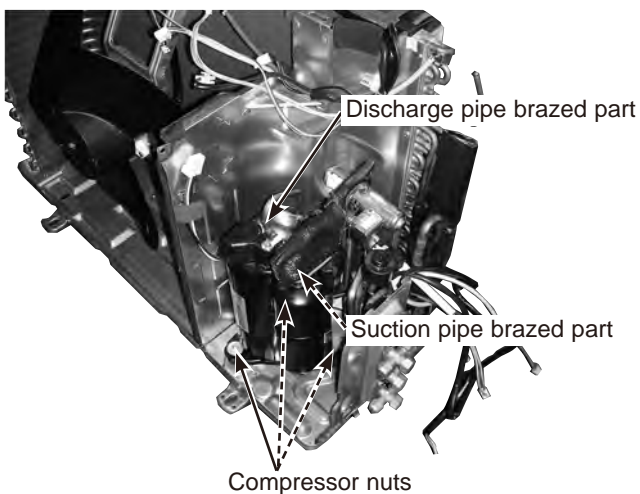

PHOTOS

Photo 7

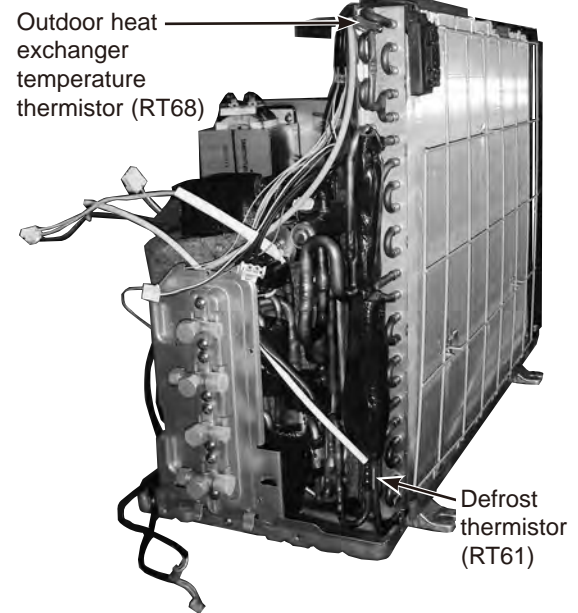

Photo 8

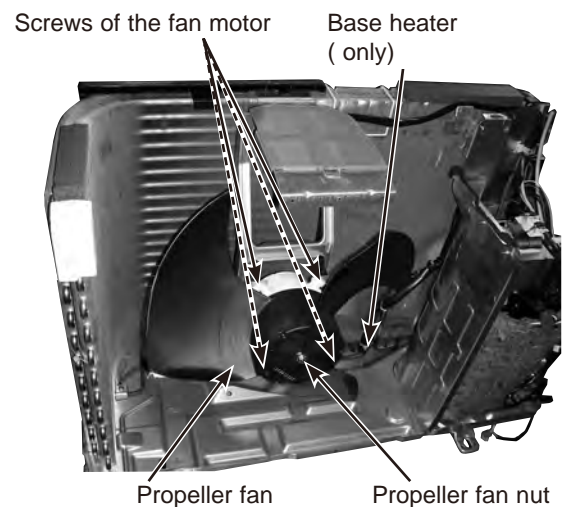
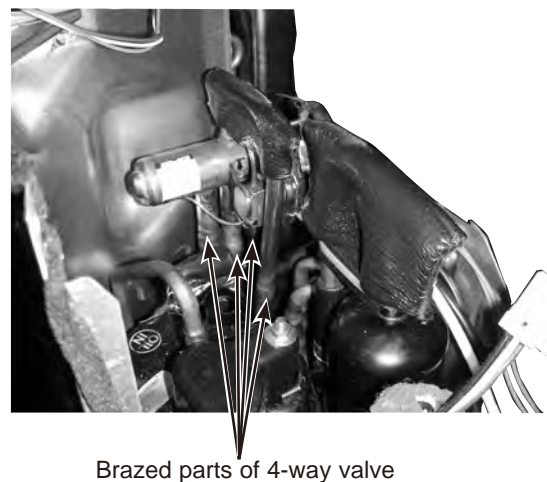
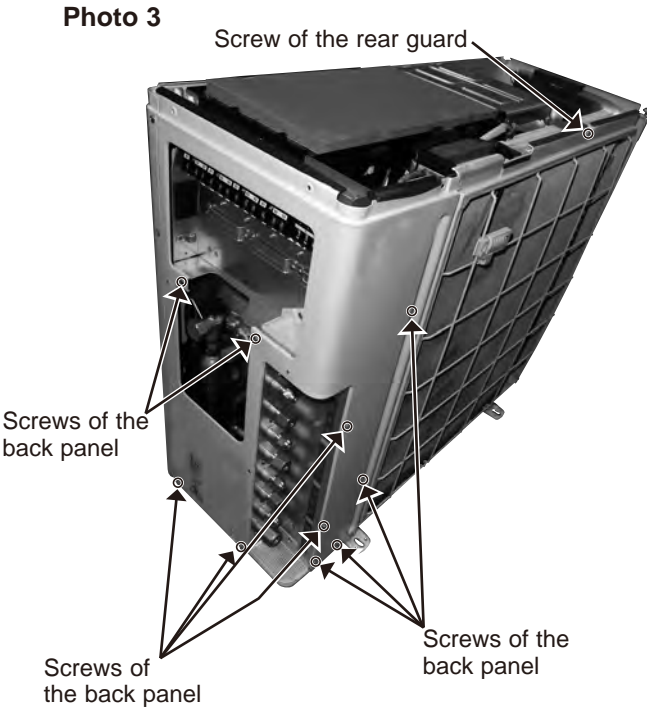
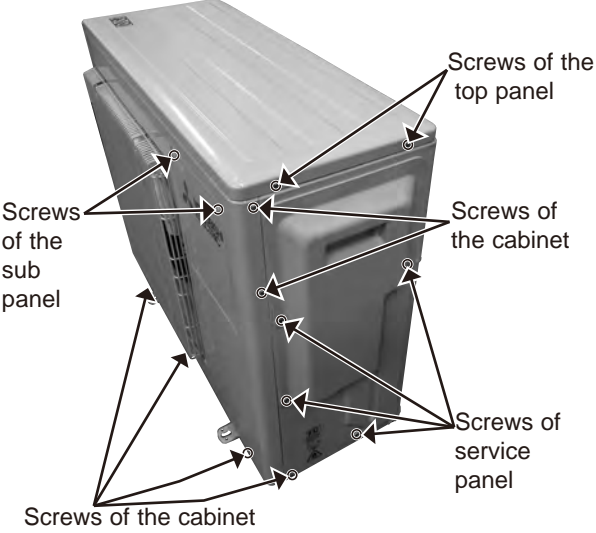
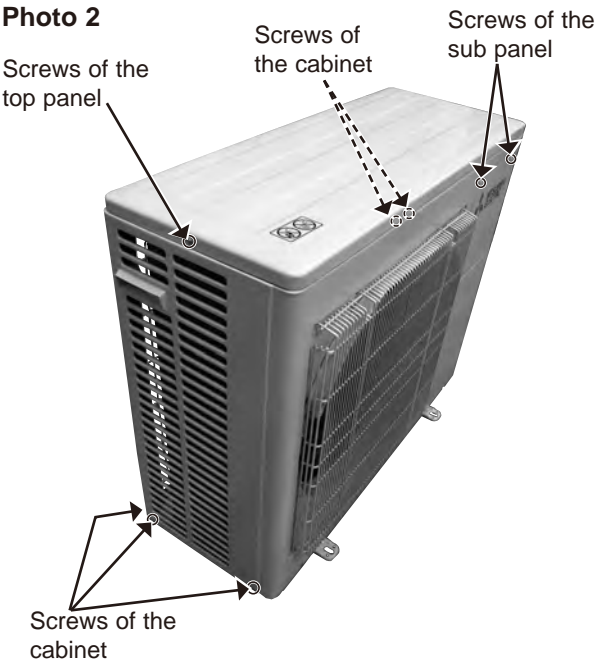

Photo 9



13-2. MXZ-3HA50VF

NOTE: Turn OFF the power supply before disassembly.

OPERATING PROCEDURE	PHOTOS
<p>1. Removing the cabinet and the panels</p> <ol style="list-style-type: none"> (1) Remove the screws of the service panel, and remove the service panel. (2) Disconnect the power supply and indoor/outdoor connecting wire. (3) Remove the screws of the top panel, and remove the top panel. (4) Remove the screws of the cabinet, and remove the cabinet. (5) Remove the screws of the back panel, and remove the back panel (Photo 3). <p>Photo 3</p> 	<p>Photo 1</p>  <p>Photo 2</p> 

OPERATING PROCEDURE

2. Removing the outdoor control P.C. board, the outdoor power P.C. board and the reactor

- (1) Remove the service panel (Photo 1).
- (2) Disconnect the power supply and indoor/outdoor connecting wire.
- (3) Remove the top panel, the cabinet, and the back panel (Photo 1, 2, 3).
- (4) Disconnect all connectors and lead wires on the outdoor control P.C. board.
- (5) Unhook the catches of the outdoor control P.C. board, and remove the outdoor control P.C. board.
- (6) Remove the screws of the electrical box assembly, unhook the catches of the electrical box assembly, and remove the electrical box assembly.
- (7) Remove the screws of outdoor control P.C. board holder, and remove the outdoor control P.C. board holder.
- (8) Remove the screws of the reactor, and remove the reactor.
- (9) Remove the screws of the reactor bed, and remove the reactor bed.
- (10) Remove the screws of the heat sink support, and remove the heat sink support.
- (11) Remove the screws fixing the outdoor power P.C. board.
- (12) Disconnect all connectors and lead wires on the outdoor power P.C. board.

Photo 7

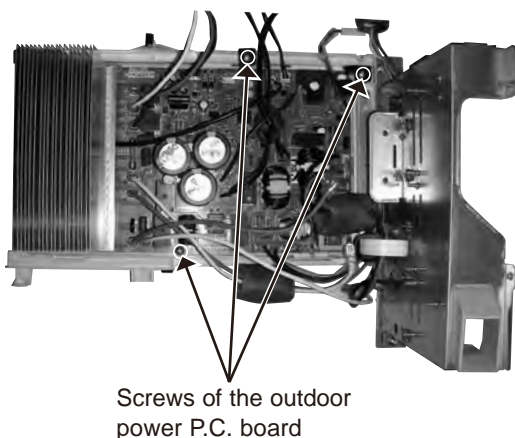

PHOTOS

Photo 4

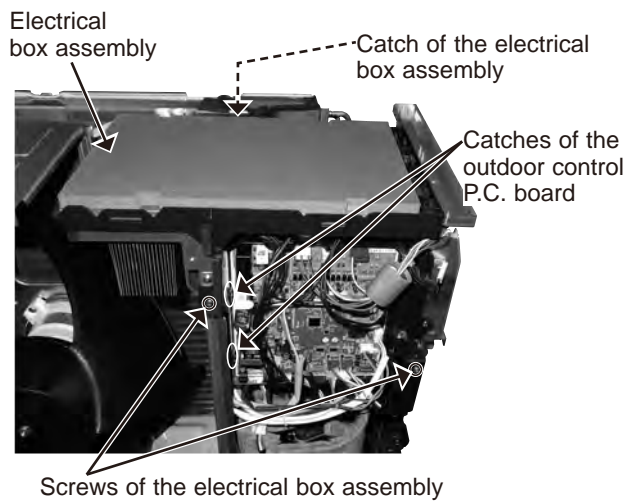

Photo 5

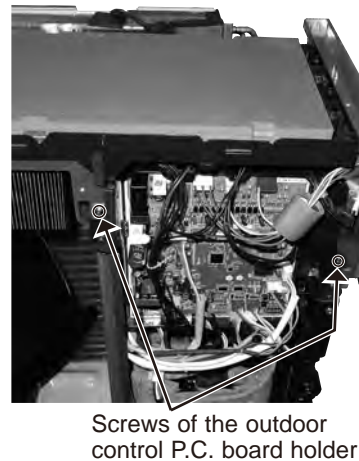
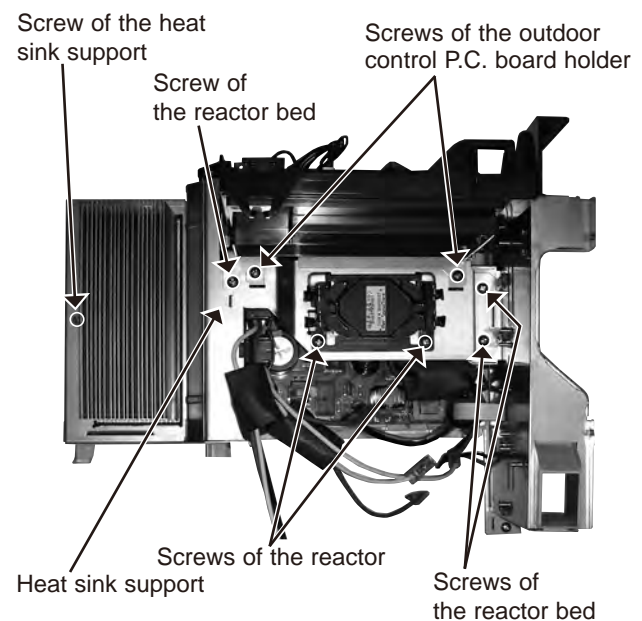

Photo 6



OPERATING PROCEDURE

3. Removing the fan motor

- (1) Remove the service panel (Photo 1).
- (2) Disconnect the power supply and indoor/outdoor connecting wire.
- (3) Remove the top panel, the cabinet, and the back panel (Photo 1, 2, 3).
- (4) Disconnect connectors CN712, CNF1, CNTH1, CNTH2, CN63H, CN791, CN792, CN793, CN797 on the outdoor control P.C. board and disconnect the relay connector of the compressor lead wire.
- (5) Remove the screws of the electrical box assembly, and remove the electrical box assembly (Photo 4).
- (6) Remove the propeller fan.
- (7) Remove the fan motor.

PHOTOS

Photo 8

Screws of the outdoor fan motor

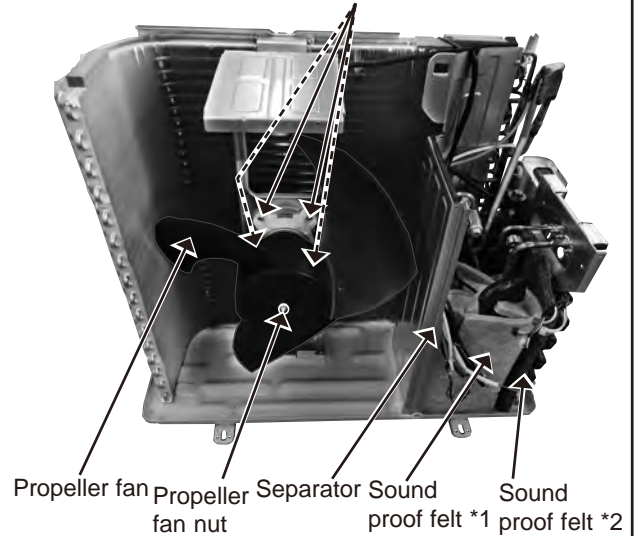

4. Removing the compressor and the 4-way valve

- (1) Remove the service panel (Photo 1).
- (2) Disconnect the power supply and indoor/outdoor connecting wire.
- (3) Remove the top panel, the cabinet, and the back panel (Photo 1, 2, 3).
- (4) Recover gas from the refrigerant circuit.
NOTE: Recover gas from the pipes until the pressure gauge shows 0 kg/cm² (0 MPa).
- (5) Disconnect the outdoor control P.C. board connectors: CN712, CNF1, CNTH1, CNTH2, CN63H, CN791, CN792, CN793, CN797.
- (6) Disconnect the compressor lead wire from the terminal of the compressor (U, V, W).
- (7) Remove the screws of the electrical box assembly, and remove the electrical box assembly (Photo 4).
- (8) Remove the propeller fan.
- (9) Remove the sound proof felt *1, *2.

NOTE: Before removing the sound proof felt, remove the hook-and-loop fastener of the top felt by the power receiver.

- (10) Remove the screws of the separator, and remove the separator.
- (11) Detach the brazed parts of the compressor suction and discharge pipes.
- (12) Remove the compressor nuts and remove the compressor.
- (13) Detach the brazed parts of the 4-way valve and pipe.

Photo 9

Hook-and-loop fastener

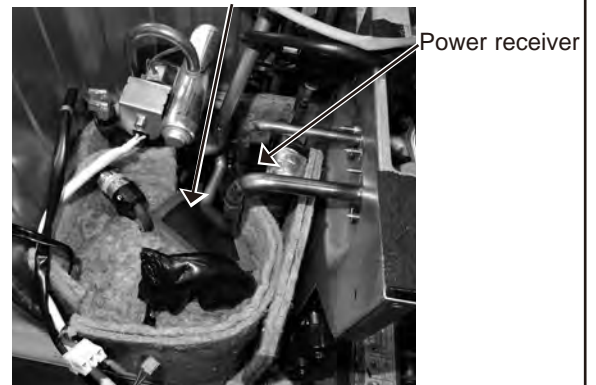
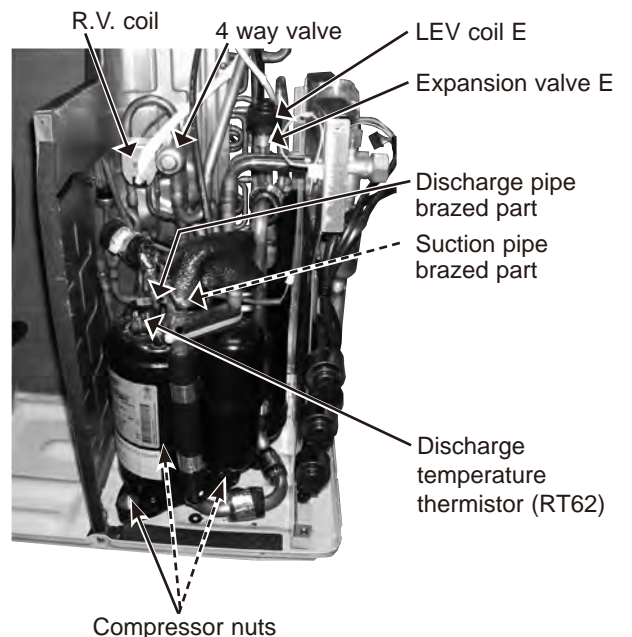

Photo 10





OPERATING PROCEDURE

PHOTOS

5. Removing the expansion valve

- (1) Remove the service panel (Photo 1).
- (2) Remove the top panel, the cabinet, and the back panel (Photo 1, 2, 3).
(Gas recovery is not required if the unit is pumped down.)
- (3) Remove the electrical parts for removing LEV R (Photo 4, 8).
- (4) Remove the LEV coils.
- (5) Detach the brazed parts of expansion valves and pipes.

Photo 11

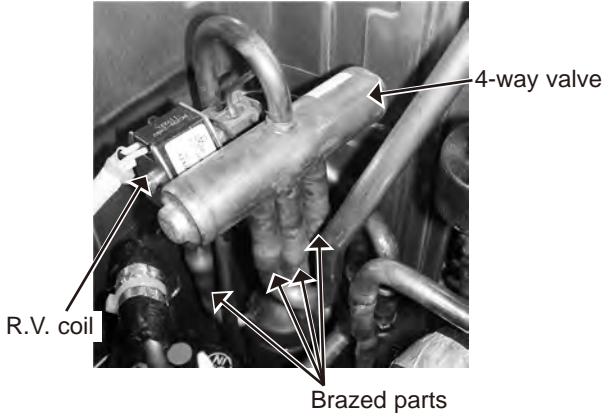
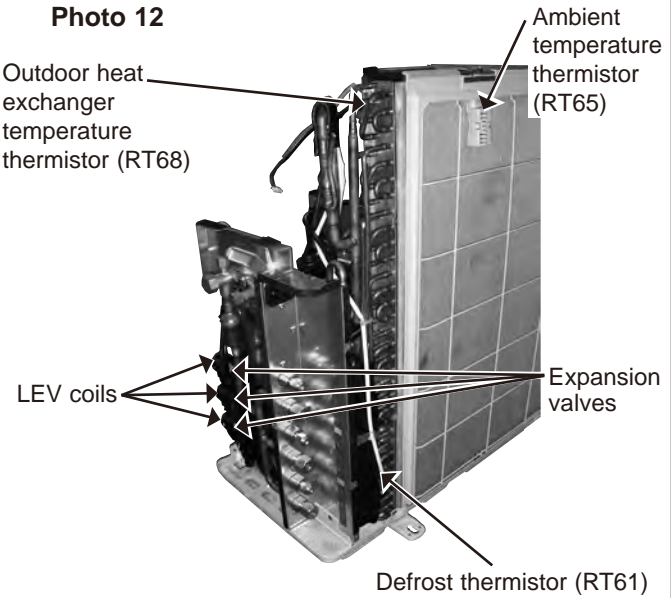

Photo 12



MITSUBISHI ELECTRIC CORPORATION

HEAD OFFICE: TOKYO BUILDING, 2-7-3, MARUNOUCHI, CHIYODA-KU, TOKYO 100-8310, JAPAN

© Copyright 2018 MITSUBISHI ELECTRIC CORPORATION
Issued: Feb. 2021. No.OBH828 REVISED EDITION-A
Published: Dec. 2018. No.OBH828
Made in Japan

Specifications are subject to change without notice.