

Air conditioner

User manual

AM***NN1PEH*** / AM***NN1DEH*** / AM***NN1DKH***

- Thank you for purchasing this Samsung air conditioner.
- Before operating this unit, please read this user manual carefully and retain it for future reference.



SAMSUNG

Contents

Safety Information	3
Safety Information	3
At a Glance	10
Indoor Unit Overview	10
Main parts	10
Operation Features	12
Operating temperature and humidity • Pairing an indoor unit with a remote control	12
Cleaning and Maintenance	13
Cleaning and Maintaining	13
Cleaning the indoor unit exterior • Cleaning the outdoor unit heat exchanger	13
Cleaning the air filter	14
Periodical maintenance	18
Troubleshooting	19
Technical specifications	22
Information about refrigerant	22
Important information: regulation regarding the refrigerant used	22
Installation Procedure	23
Installation Procedure	23



**Correct Disposal of This Product
(Waste Electrical & Electronic Equipment)**

(Applicable in countries with separate collection systems)

This marking on the product, accessories or literature indicates that the product and its electronic accessories (e.g. charger, headset, USB cable) should not be disposed of with other household waste at the end of their working life. To prevent possible harm to the environment or human health from uncontrolled waste disposal, please separate these items from other types of waste and recycle them responsibly to promote the sustainable reuse of material resources. Household users should contact either the retailer where they purchased this product, or their local government office, for details of where and how they can take these items for environmentally safe recycling.

Business users should contact their supplier and check the terms and conditions of the purchase contract. This product and its electronic accessories should not be mixed with other commercial wastes for disposal.

For information on Samsung's environmental commitments and product-specific regulatory obligations, e.g. REACH, WEEE, Batteries, visit: www.samsung.com/uk/aboutsamsung/sustainability/environment/our-commitment/data/

Safety Information

Before using your new air conditioner, please read this manual thoroughly to ensure that you know how to safely and efficiently operate the extensive features and functions of your new appliance.





Because the following operating instructions cover various models, the characteristics of your air conditioner may differ slightly from those described in this manual. If you have any questions, call your nearest contact centre or find help and information online at www.samsung.com.

WARNING

Hazards or unsafe practices that may result in severe personal injury or death.

CAUTION

Hazards or unsafe practices that may result in minor personal injury or property damage.

-  Follow directions.
-  Do NOT attempt.
-  Make sure the machine is grounded to prevent electric shock.
-  Cut-off the power supply.
-  Do NOT disassemble.

FOR INSTALLATION

WARNING

-  **Use the power line with the power specifications of the product or higher and use the power line for this appliance only. In addition, do not use an extension line.**
 - Extending the power line may result in electric shock or fire.
 - Do not use an electric transformer. This may result in electric shock or fire.
 - If the voltage/frequency/rated current condition is different, it may cause fire.

Safety Information

- ❗ **The installation of this appliance must be performed by a qualified technician or service company.**
 - Failing to do so may result in electric shock, fire, explosion, problems with the product, or injury.

Install a switch and circuit breaker dedicated to the air conditioner.

- Failing to do so may result in electric shock or fire.

Fix the outdoor unit firmly so that the electric part of the outdoor unit is not exposed.

- Failing to do so may result in electric shock or fire.

- ⊘ **Do not install this appliance near a heater, inflammable material. Do not install this appliance in a humid, oily or dusty location, in a location exposed to direct sunlight and water (rain drops). Do not install this appliance in a location where gas may leak.**

- This may result in electric shock or fire.

Never install the outdoor unit in a location such as on a high external wall where it could fall.

- If the outdoor unit falls, it may result in injury, death or property damage.

- ⚡ **This appliance must be properly grounded. Do not ground the appliance to a gas pipe, plastic water pipe, or telephone line.**

- Failure to do so may result in electric shock, fire, an explosion, or other problems with the product.
- Never plug the power cord into a socket that is not grounded correctly and make sure that it is in accordance with local and national codes.

⚠ CAUTION

- ❗ **Install your appliance on a level and hard floor that can support its weight.**
 - Failing to do so may result in abnormal vibrations, noise, or problems with the product.

Install the drain hose properly so that water is drained correctly.

- Failing to do so may result in water overflowing and property damage. Avoid adding drain to waste pipes as odours may arise in the future.

! When installing the outdoor unit, make sure to connect the drain hose so that draining is performed correctly.

- The water generated during the heating operation in the outdoor unit may overflow and result in property damage.
In particular, in winter, if a block of ice falls, it may result in injury, death or property damage.

Do not install the product in a place where thermo-hygrostat is needed (such as server room, machinery room, computer room, etc.)

- Those places do not provide guaranteed operation condition of the product therefore performance can be poor in these places.

FOR POWER SUPPLY

! WARNING

! When the circuit breaker is damaged, contact your nearest service centre.

⊘ Do not pull or excessively bend the power line. Do not twist or tie the power line. Do not hook the power line over a metal object, place a heavy object on the power line, insert the power line between objects, or push the power line into the space behind the appliance.

- This may result in electric shock or fire.

! CAUTION

⚡ When not using the air conditioner for a long period of time or during a thunder/lightning storm, cut the power at the circuit breaker.

- Failing to do so may result in electric shock or fire.

FOR USING

! WARNING

! If the appliance is flooded, please contact your nearest service centre.

- Failing to do so may result in electric shock or fire.

If the appliance generates a strange noise, a burning smell or smoke, unplug the power plug immediately and contact your nearest service centre.

- Failing to do so may result in electric shock or fire.

Safety Information

! In the event of a gas leak (such as propane gas, LP gas, etc.), ventilate immediately without touching the power line. Do not touch the appliance or power line.

- Do not use a ventilating fan.
- A spark may result in an explosion or fire.

To reinstall the air conditioner, please contact your nearest service centre.

- Failing to do so may result in problems with the product, water leakage, electric shock, or fire.
- A delivery service for the product is not provided. If you reinstall the product in another location, additional construction expenses and an installation fee will be charged.
- Especially, when you wish to install the product in an unusual location such as in an industrial area or near the seaside where it is exposed to salt in the air, please contact your nearest service centre.

⊘ Do not touch the circuit breaker with wet hands.

- This may result in electric shock.

Do not turn the air conditioner off with the circuit breaker while it is operating.

- Turning the air conditioner off and then on again with the circuit breaker may cause a spark and result in electric shock or fire.

After unpacking the air conditioner, keep all packaging materials well out of the reach of children, as packaging materials can be dangerous to children.

- If a child places a bag over its head, it may result in suffocation.

Do not touch the front panel with your hands or fingers during the heating operation.

- This may result in electric shock or burns.

Do not insert your fingers or foreign substances into the outlet when the air conditioner is operating or the front panel is closing.

- Take special care that children do not injure themselves by inserting their fingers into the product.

⊘ Do not insert your fingers or foreign substances into the air inlet/outlet of the air conditioner.

- Take special care that children do not injure themselves by inserting their fingers into the product.

Do not strike or pull the air conditioner with excessive force.

- This may result in fire, injury, or problems with the product.

Do not place an object near the outdoor unit that allows children to climb onto the machine.

- This may result in children seriously injuring themselves.

Do not use this air conditioner for long periods of time in badly ventilated locations or near infirm people.

- Since this may be dangerous due to a lack of oxygen, open a window at least once an hour.

⚡ If any foreign substance such as water has entered the appliance, cut the power by unplugging the power plug and turning the circuit breaker off and then contact your nearest service centre.

- Failing to do so may result in electric shock or fire.

⊘ Do not attempt to repair, disassemble, or modify the appliance yourself.

- Do not use any fuse (such as copper, steel wire, etc.) other than the standard fuse.
- Failing to do so may result in electric shock, fire, problems with the product, or injury.

⚠ CAUTION

❗ Do not place objects or devices under the indoor unit.

- Water dripping from the indoor unit may result in fire or property damage.

Check that the installation frame of the outdoor unit is not broken at least once a year.

- Failing to do so may result in injury, death or property damage.

Max current is measured according to IEC standard for safety and current is measured according to ISO standard for energy efficiency.

Do not install the product in a ship or a vehicle (such as a campervan).

- Salt, vibration or other environmental factor may cause the product malfunction, electric shock or fire.

Safety Information

⊘ **Do not stand on top of the appliance or place objects (such as laundry, lighted candles, lighted cigarettes, dishes, chemicals, metal objects, etc.) on the appliance.**

- This may result in electric shock, fire, problems with the product, or injury.

Do not operate the appliance with wet hands.

- This may result in electric shock.

Do not spray volatile material such as insecticide onto the surface of the appliance.

- As well as being harmful to humans, it may also result in electric shock, fire or problems with the product.

Do not drink the water from the air conditioner.

- The water may be harmful to humans.

Do not apply a strong impact to the remote controller and do not disassemble the remote controller.

Do not touch the pipes connected with the product.

- This may result in burns or injury.

Do not use this air conditioner to preserve precision equipment, food, animals, plants or cosmetics, or for any other unusual purposes.

- This may result in property damage.

Avoid directly exposing humans, animals or plants to the air flow from the air conditioner for long periods of time.

- This may result in harm to humans, animals or plants.

This appliance is not intended for use by persons (including children) with reduced physical, sensory or mental capabilities, or lack of experience and knowledge, unless they have been given supervision or instruction concerning use of the appliance by a person responsible for their safety. Children should be supervised to ensure that they do not play with the appliance.

-
- ⊘ For use in Europe: This appliance can be used by children aged from 8 years and above and persons with reduced physical, sensory or mental capabilities or lack of experience and knowledge if they have been given supervision or instruction concerning use of the appliance in a safe way and understand the hazards involved. Children shall not play with the appliance. Cleaning and user maintenance shall not be made by children without supervision.

FOR CLEANING

WARNING

- ⊘ Do not clean the appliance by spraying water directly onto it. Do not use benzene, thinner, alcohol or acetone to clean the appliance.
- This may result in discoloration, deformation, damage, electric shock or fire.

Before cleaning or performing maintenance, unplug the air conditioner from the wall socket and wait until the fan stops.

- Failing to do so may result in electric shock or fire.

CAUTION

- ❗ Take care when cleaning the surface of the heat exchanger of the outdoor unit since it has sharp edges.
- To avoid cutting your fingers, wear thick cotton gloves when cleaning it.
 - This should be done by a qualified technician please contact your installer or service centre.
- ⊘ Do not clean the inside of the air conditioner by yourself.
- For cleaning inside the appliance, contact your nearest service centre.
 - When cleaning the internal filter, refer to the descriptions in the 'Cleaning and Maintaining' section.
 - Failure to do may result in damage, electric shock or fire.
 - Make sure to prevent any injury from sharp edges of the surface when handling the heat exchanger.

Indoor Unit Overview

Main parts

The indoor unit and its display may look slightly different from the illustration shown below, depending on the model and the panel type.

PC1*WFMAN / PC1*WCMAN

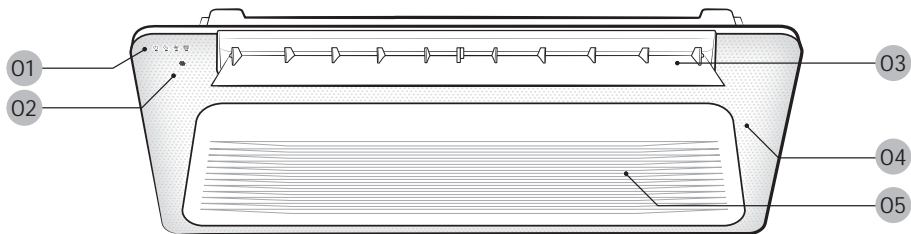

01 Display







02 Remote control sensor

03 Airflow blade

04 Wind-Free panel

(You can use the Wind-Free Cooling function when the Cool, Dry, or Fan mode is running.)
(Refer to the remote control manual for product operation)

05 Air intake



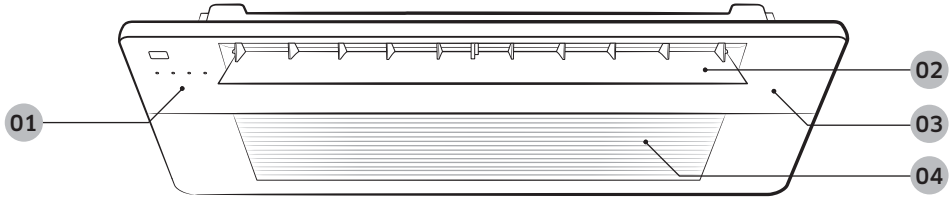

Indication	Function
	Operation indicator <ul style="list-style-type: none"> • Heating and cooling model: Operation(Blue) / Defrost(Yellow) • Cooling only model: Operation indicator
	Timer indicator
	Fan indicator
	Filter cleaning indicator

PC1NUSMAN/PC1NUPMAN/PC1MWSKAN/PC1NWSMAN/PC1BWSMAN

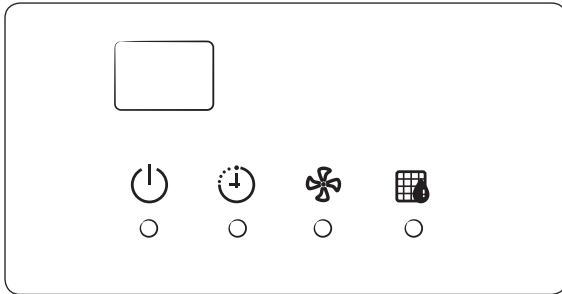

01 Display



Indication	Function
	Remote control sensor
	Operation indicator <ul style="list-style-type: none"> • Heating and cooling model: Operation(Blue) / Defrost(Yellow) • Cooling only model: Operation indicator
	Timer indicator
	Fan indicator
	Filter cleaning indicator

02 Air flow blade

03 Panel

04 Air intake

Operation Features

Operating temperature and humidity

When using the air conditioner follow the operating temperature and humidity ranges.

Mode	Outdoor temperature	Indoor temperature	Indoor humidity
Cool mode	Depending on the outdoor unit specifications	18°C to 32°C	80% or less
Heat mode		30°C or less	-
Dry mode		18°C to 32°C	

CAUTION



- If you use the air conditioner at a relative humidity above 80%, it may cause a formation of condensation and a leakage of water on the floor.
- The rated heating capacity is based on an outdoor temperature of 7°C. If the outdoor temperature goes down below 0°C, heating efficiencies may decrease depending on the temperature conditions.
- If the indoor unit is out of the operating temperature and humidity range, the safety device may operate and the air conditioner may stop.

Pairing an indoor unit with a remote control

When using multiple indoor unit, you can control individually pairing remote control and indoor unit. Set by remote control when the indoor unit is off.

 ► Zone1~4 ►  ►  (5 sec)

NOTE

- After push the , have to push  within 60 seconds.
- Each indoor unit number setting must be set by the installer when installing. Contact service centre to reset indoor unit number.

Cleaning and Maintaining

⚠ Before cleaning the indoor unit, be sure to turn off the auxiliary power switch.

Cleaning the indoor unit exterior

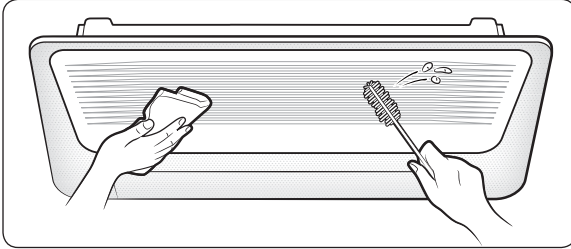

Wipe the surface of the indoor unit with a tepid damp cloth.

Remove the dust accumulated in the narrow gaps of the product with a soft brush.

⚠ CAUTION

- Do not use alkaline detergent, sulphuric acid, hydrochloric acid, or organic solvents (such as thinner, kerosene, and acetone) to clean the surfaces.
- Do not attach any stickers on the surfaces because this may cause damage.
- When you clean the heat exchanger on the indoor unit, you need to disassemble the indoor unit. Therefore, you must contact the local service center for help.

Cleaning the outdoor unit heat exchanger

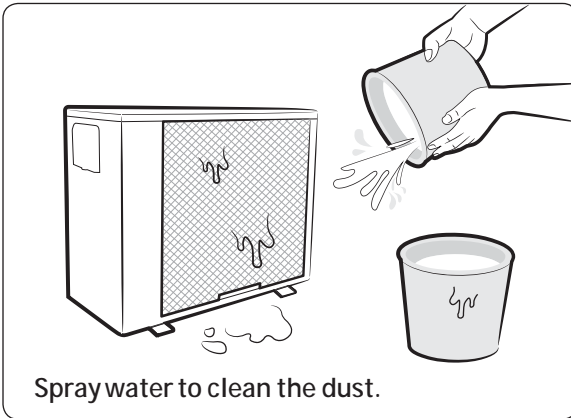

Spray water to clean the dust.

⚠ CAUTION

- The heat exchanger of the outdoor unit has sharp edges. Take care when cleaning its surface.

📄 NOTE

- If it is difficult to clean the heat exchanger of the outdoor unit, contact the local service center.

Cleaning and Maintaining

Cleaning the air filter

⚠ CAUTION

- Before cleaning the indoor unit, be sure to turn off the auxiliary power switch.
- Be sure to hold the grille with a hand to prevent dropping from the opening of the front grille.

📄 NOTE

- When removing the grill completely, unhook the safety hooks on both sides of the grill.

PC1*WFMAN / PC1*WCMAN / PC1NUSMAN

1 Detaching the air filter

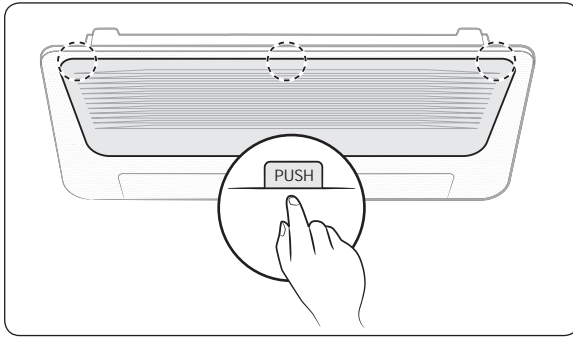

Press the **Push** signs on the front panel, then open the grille.

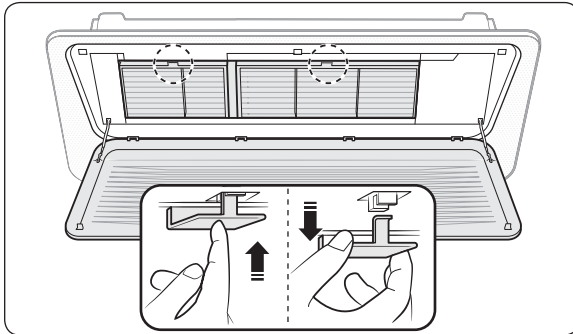

Press the Push signs (▽) on the air filter. Grab the handle of the air filter and pull it out from the indoor unit with your hand.

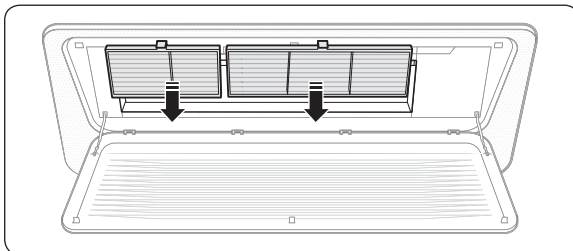

Pull the air filter out of the indoor unit.

PC1NUPMAN

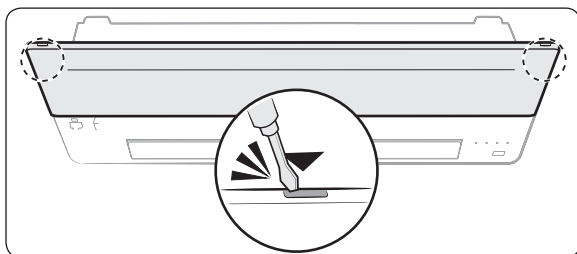

Insert a driver at the marked points and open the front grille.

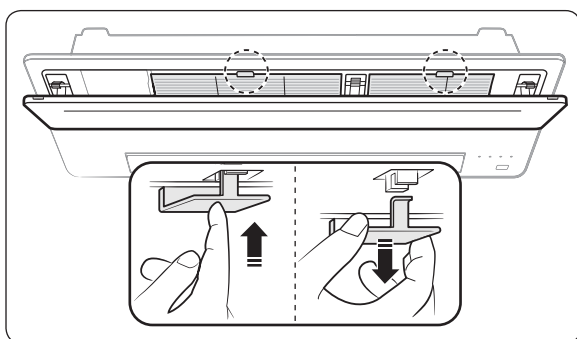

Press the **Push** signs on the air filter.
Grab the handle of the air filter and pull it out from the indoor unit.

PC1MWSKAN/PC1NWSMAN/PC1BWSMAN

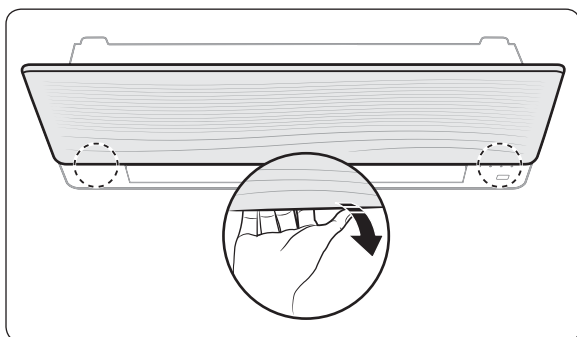

Insert your hand into the front grille and pull out the front grille to open it.

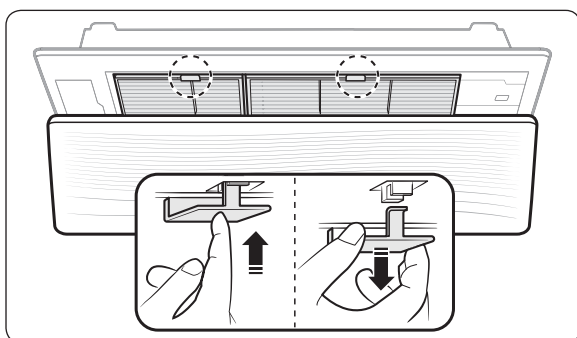

Press the **Push** signs on the air filter.
Grab the handle of the air filter and pull it out from the indoor unit.

⚠ CAUTION

- The grille is connected to the panel. Do not forcibly detach the grille. If the connection structure is broken, the grille may fall down, which may cause an injury.

Cleaning and Maintaining

2 Cleaning the air filter

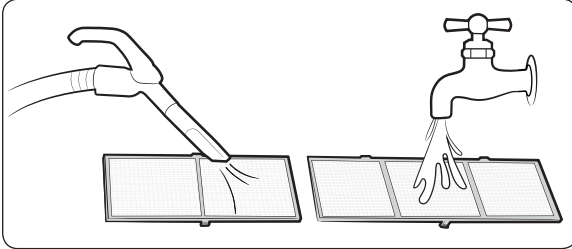

Clean the air filter with a vacuum cleaner or soft brush. If dust is too heavy, then rinse it with running water and dry it in a ventilated area.

⚠ CAUTION

- Do not scrub the air filter with a brush or other cleaning utensil. This may damage the filter.

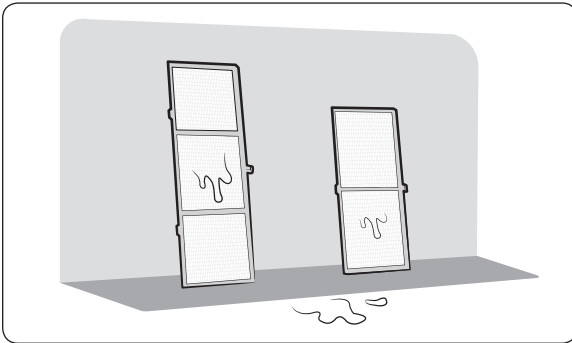

📄 NOTE

- If the air filter dries in a humid area, it may produce offensive odours. Clean it again and dry it in a well-ventilated area.
- The cleaning period may differ depending on the usage and environmental conditions, so clean the air filter every week if the air conditioner is in the dusty area.
- You can request a filter cleaning service. Note that it is a charged service.

3 Reassembling the air filter

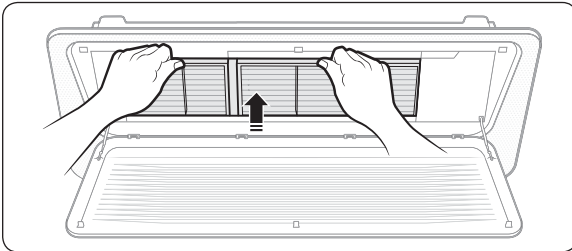

To assemble the air filter, proceed in reverse order of detaching.

⚠ CAUTION

- If the indoor unit is used without the air filter, it may be damaged due to dust.

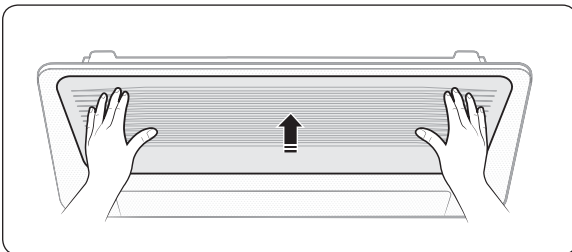

4 Resetting the air filter

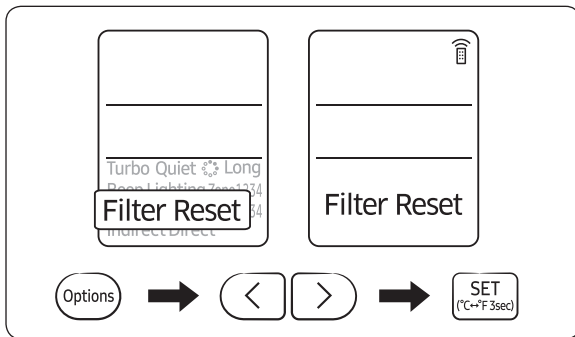
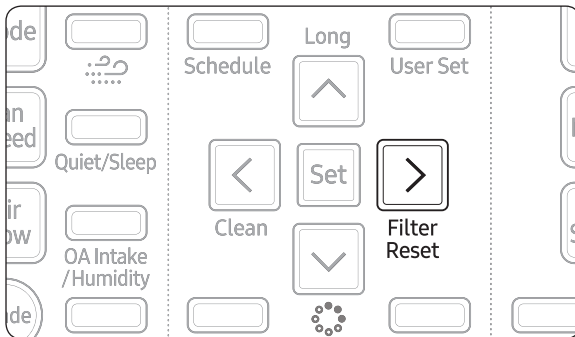

After cleaning and reassembling the air filter, be sure to reset the filter-cleaning reminder as follows:

- Indoor unit with the wired remote control: Press the **Filter Reset** button.
- Indoor unit with the wireless remote control: Press the **Options** button → < or > → (**Filter Reset**) Blinking → press the **SET** button.

NOTE

- Be sure to reset the filter-cleaning reminder every time you clean the air filter although the filter reset indicator (📅) does not blink.



Cleaning and Maintaining

Periodical maintenance



Unit	Maintenance item	Interval	Requires qualified technicians
Indoor unit	Clean the air filter.	At least once a month	
	Clean the condensate drain pan.	Once a year	Required
	Clean the heat exchanger.	Once a year	Required
	Clean the condensate drain pipe.	Once every 4 months	Required
	Replace the remote control batteries.	At least once a year	
Outdoor unit	Clean the heat exchanger on the outside of the unit.	Once every 4 months	Required
	Clean the heat exchanger on the inside of the unit.	Once a year	Required
	Clean the electric components with jets of air.	Once a year	Required
	Verify that all the electric components are firmly tightened.	Once a year	Required
	Clean the fan.	Once a year	Required
	Verify that the fan assemblies are firmly tightened.	Once a year	Required
	Clean the condensate drain pan.	Once a year	Required

Troubleshooting

Refer to the following chart if the air conditioner operates abnormally. This may save time and unnecessary expense.

Problem	Solution
The air conditioner does not operate immediately after it has been restarted.	<ul style="list-style-type: none"> Because of the protective mechanism, the appliance does not start operating immediately to keep the unit from overloading. The air conditioner will start in 3 minutes.
The air conditioner does not operate at all.	<ul style="list-style-type: none"> Check if the power plug is properly connected. Check whether the auxiliary power switch (MCCB, ELB) is turned on. If the auxiliary power switch (MCCB, ELB) is turned off, the air conditioner does not work although you press the  (Power) button. When you clean the air conditioner or do not use it for an extended period of time, turn off the auxiliary power switch (MCCB, ELB). After the air conditioner is not used for an extended period of time, be sure to turn on the auxiliary power switch (MCCB, ELB) 6 hours before starting operation. <p> NOTE</p> <ul style="list-style-type: none"> The auxiliary power switch (MCCB, ELB) is sold separately. Make sure that auxiliary power switch (MCCB, ELB) is installed in the distribution box inside the building. <ul style="list-style-type: none"> If the air conditioner is turned off by the Timed off function, turn on the air conditioner again by pressing the  (Power) button.
The temperature does not change.	<ul style="list-style-type: none"> Check whether the Fan mode is running. In the Fan mode, the air conditioner controls the set temperature automatically, and you cannot change the set temperature.
Warm air does not come out of the air conditioner.	<ul style="list-style-type: none"> Check whether the outdoor unit is designed for cooling only. In this case, warm air does not come out although you select the Heat mode. Check whether the remote control is designed only for cooling only. Use a remote control that supports both cooling and heating.
The fan speed does not change.	<ul style="list-style-type: none"> Check whether the Auto or Dry mode is running. In these modes, the air conditioner controls the fan speed automatically, and you cannot change the fan speed.
The wireless remote control does not operate.	<ul style="list-style-type: none"> Check whether the batteries are discharged. Replace the batteries with new ones. Make sure that nothing is blocking the remote control sensor. Check whether any strong lighting sources are near the air conditioner. Strong light which comes from fluorescent bulbs or neon signs may interfere with the remote control.

Cleaning and Maintaining

Problem	Solution
The wired remote control does not operate.	<ul style="list-style-type: none"> Check whether the  indicator is displayed at the bottom right of the remote control display. In this case, turn off both the air conditioner and the auxiliary power switch, and then contact a service centre.
The air conditioner is not turned on or off immediately with the wired remote control.	<ul style="list-style-type: none"> Check whether the wired remote control is set for group control. In this case, the air conditioners connected to the wired remote control are turned on or off sequentially. This operation takes up to 32 seconds.
The Timed on/off function does not operate.	<ul style="list-style-type: none"> Check whether you pressed the  (SET) button on the remote control after setting the on/off time. Set the on/off time.
The indoor unit display blinks continuously.	<ul style="list-style-type: none"> Turn on the air conditioner again by pressing the  (Power) button. Turn off and then turn on the auxiliary power switch, and then turn on the conditioner. If the indoor unit display is still blinking, contact a service centre.
The air is not cool or warm enough.	<ul style="list-style-type: none"> In the Cool mode, cool air does not come out if the set temperature is higher than the current temperature. <ul style="list-style-type: none"> Remote control: Press the Temperature button repeatedly until the set temperature (minimum: 18°C) is set to lower than the current temperature. In the Heat mode, warm air does not come out if the set temperature is lower than the current temperature. <ul style="list-style-type: none"> Remote control: Press the Temperature button repeatedly until the set temperature (maximum: 30°C) is set to higher than the current temperature. Both cooling and heating do not operate in the Fan mode. Select the Cool, Heat, Auto, or Dry mode. Check whether the air filter is blocked with dirt. A dusty filter may decrease the cooling and heating efficiencies. Clean the air filter frequently. If a cover is on the outdoor unit or any obstacle is present near the outdoor unit, remove them. Install the outdoor unit in a well-ventilated place. Avoiding places exposed to direct sunlight or close to a heating appliance. Place a sunscreen over the outdoor unit to protect it from direct sunlight. If the indoor unit is installed in a place exposed to direct sunlight, pull the curtains on the windows.

Problem	Solution
The air is not cool or warm enough.	<ul style="list-style-type: none"> • Close the windows and doors to maximize the cooling and heating efficiencies. • If the Cool mode is stopped and then started immediately, cool air comes out after about 3 minutes to protect the compressor of the outdoor unit. • When the Heat mode is started, warm air does not come out immediately to prevent cool air from coming out at the beginning. • If the refrigerant pipe is too long, the cooling and heating efficiencies may be decreased. Avoid exceeding the maximum pipe length.
The air conditioner makes strange noises.	<ul style="list-style-type: none"> • In certain conditions (especially, when the outdoor temperature is lower than 20°C), a hissing, rumbling, or splashing sound may be heard while the refrigerant is circulating through the air conditioner. This is a normal operation. • When you press the  (Power) button on the remote control, noise may be heard from the drain pump inside the air conditioner. This noise is a normal sound.
Unpleasant odours permeate the room.	<ul style="list-style-type: none"> • If the air conditioner is running in a smoky area or if there is a smell entering from outside, ventilate the room properly. • If both indoor temperature and indoor humidity are high, operate the air conditioner in the Clean or Fan mode for 1 to 2 hours. • If the air conditioner has not been operated for an extended period of time, clean the indoor unit and then operate the air conditioner in the Fan mode for 3 to 4 hours to dry the inside of the indoor unit for removal of unpleasant odours. • If the air filter blocked with dirt, clean the air filter.
Steam is produced on the indoor unit.	<ul style="list-style-type: none"> • In winter, if the indoor humidity is high, steam may be produced around the air outlet while the defrost function is running. This is a normal operation.
The outdoor unit fan continues to operate when the air conditioner is turned off.	<ul style="list-style-type: none"> • When the air conditioner is turned off, the outdoor unit fan may continue to operate to reduce noise of the refrigerant gas. This is a normal operation.
Water drops from the piping connections of the outdoor unit.	<ul style="list-style-type: none"> • Condensation may develop due to the difference in temperature. This is a normal condition.
Steam is produced on the outdoor unit.	<ul style="list-style-type: none"> • In winter, when the air conditioner runs in the Heat mode, the frost on the heat exchanger melts and steam may be produced. This is a normal operation, neither product malfunction nor a fire.

Technical specifications

Type	Model	New weight	Net dimension(W x D x H)
Indoor unit	AM017NN1PEH	8.0 kg	740 mm x 360 mm x 135 mm
	AM022NN1PEH	8.0 kg	740 mm x 360 mm x 135 mm
	AM022NN1DEH	10.0 kg	970 mm x 410 mm x 135 mm
	AM028NN1DEH	10.0 kg	970 mm x 410 mm x 135 mm
	AM036NN1DEH	10.0 kg	970 mm x 410 mm x 135 mm
	AM056NN1DEH	13.5 kg	1,200 mm x 450 mm x 138 mm
	AM071NN1DEH	13.5 kg	1,200 mm x 450 mm x 138 mm
	AM022NN1DKH	10.0 kg	970 mm x 410 mm x 135 mm
	AM028NN1DKH	10.0 kg	970 mm x 410 mm x 135 mm
	AM036NN1DKH	10.0 kg	970 mm x 410 mm x 135 mm

Information about refrigerant

Important information: regulation regarding the refrigerant used

This product contains fluorinated greenhouse gases. Do not vent gases into the atmosphere.

CAUTION

- If the system contains 5 tCO₂e or more of fluorinated greenhouse gases, it must be checked for leakage at least once every 12 months, according to regulation No. 517/2014. This activity must be covered by qualified personnel only. In the case of the situation above, the installer (or authorized person with responsibility for final check) must provide a maintenance book, with all the information recorded, according to REGULATION (EU) No. 517/2014 OF THE EUROPEAN PARLIAMENT AND OF THE COUNCIL of 16 April 2014 on fluorinated greenhouse gases.

Refrigerant type	GWP value
R-410A	2088

- GWP: Global Warming Potential
- Calculating tCO₂e: kg x GWP/1000

Installation Procedure

Step 1 Installing the indoor unit

When deciding on the location of the air conditioner the following restrictions must be taken into account.

- 1 Place the pattern sheet on the ceiling at the spot where you want to install the indoor unit.

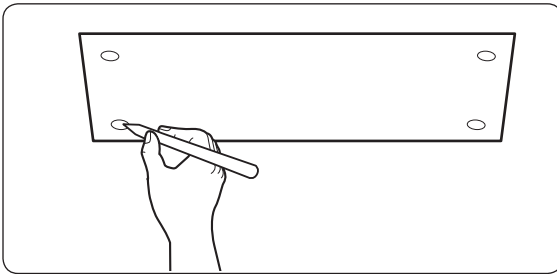

NOTE

- Since the diagram is made of paper, it may shrink or stretch slightly due to temperature or humidity. For this reason, before drilling the holes, be sure to maintain the correct dimensions between the markings.
- 2 Insert bolt anchors, use existing ceiling supports or construct a suitable support as shown in figure.

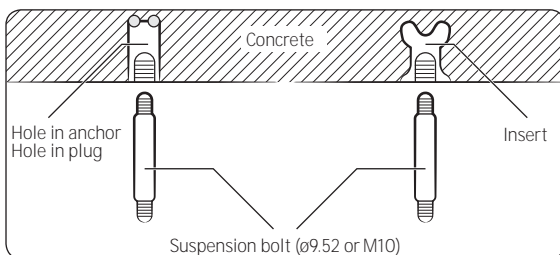

- 3 Install the suspension bolts, depending on the ceiling type.

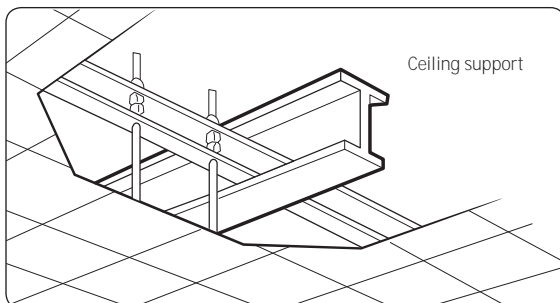

CAUTION

- Make sure that the ceiling is strong enough to support the weight of the indoor unit. Before hanging the unit, test the strength of each attached suspension bolt.
 - If the length of the suspension bolt is more than 1.5 m, you are required to prevent vibration.
 - If this is not possible, create an opening on the false ceiling in order to be able to use it to perform the required operations on the indoor unit.
- 4 Screw eight nuts and washers to the suspension bolts, making space for hanging the indoor unit.

CAUTION

- You must install all of the suspension rods.
 - It is important to leave sufficient space in the false ceiling to allow access for maintenance or repairs to the drainage pipe connection, the refrigerant pipe connection, or to remove the unit if necessary.
- 5 Hang the indoor unit to the suspension bolts between two nuts. Screw the nuts to suspend the unit.

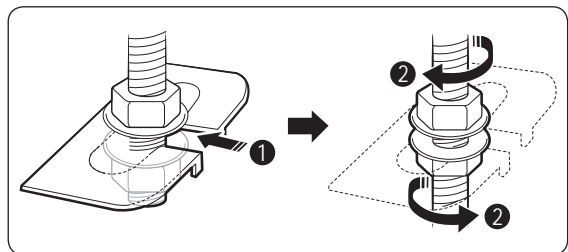

- 6 Check the level of the indoor unit by using a leveler.
 - A tilt of the indoor unit may cause malfunction of a built-in float switch and water leaks.

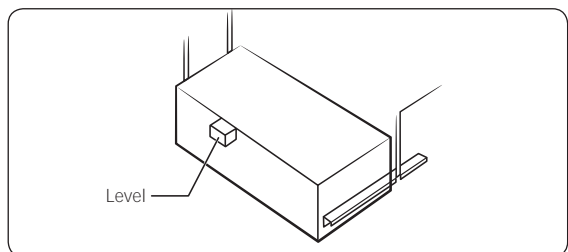

Installation Procedure

- 7 Adjust the unit to the appropriate position, taking into account the installation area for the front panel.
- Place the pattern sheet on the indoor unit.
 - Adjust the space between the ceiling and the indoor unit by using a dimension gauge.
 - Fix the indoor unit securely after adjusting the level of the unit by using a leveller.
 - Remove the pattern sheet and install the front panel.

(Unit: mm)

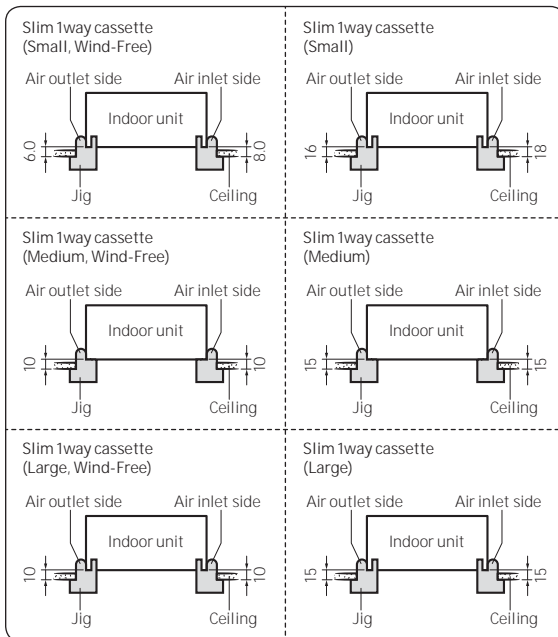

Step 2 Performing the gas leak test

To identify potential gas leaks on the indoor unit, inspect the connection area of each refrigerant pipe using a leak detector for R-410A.

Before recreating the vacuum and recirculating the refrigerant gas, pressurize the whole system with nitrogen (using a cylinder with a pressure reducer) at a pressure above 4.1 MPa in order to immediately detect leaks on the refrigerant fittings.

Made vacuum for 15 minutes and pressurizing system with nitrogen.

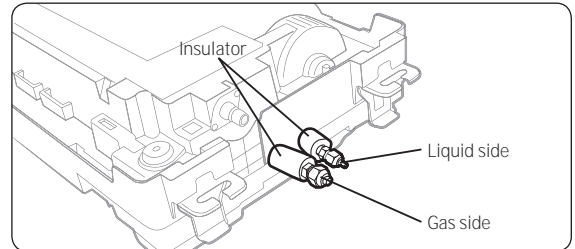

Step 3 Insulating the refrigerant pipes

Once you have checked that there are no leaks in the system, you can insulate the piping and hose.

- To avoid condensation problems, place Acrylonitrile Butadiene Rubber separately around each refrigerant pipe.

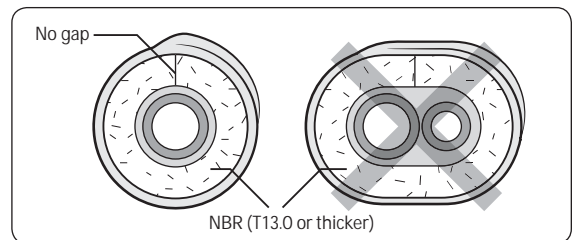

NOTE

- Always make the seam of pipes face upwards.
- Wind insulating tape around the pipes and drain hose avoiding compressing the insulation too much.
- Finish wrapping insulating tape around the rest of the pipes leading to the outdoor unit.
- The pipes and electrical cables connecting the indoor unit with the outdoor unit must be fixed to the wall with suitable ducts.

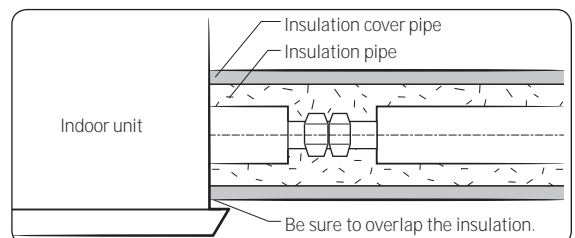

⚠ CAUTION

- Must fit tightly against body without any gap.
- Install the insulation not to get wider and use the adhesives on the connection part of it to prevent moisture from entering.
- Wind the refrigerant pipe with insulation tape if it is exposed to outside sunlight.
- Install the refrigerant pipe respecting that the insulation does not get thinner on the bent part or hanger of pipe.
- Add the additional insulation if the insulation plate gets thinner.

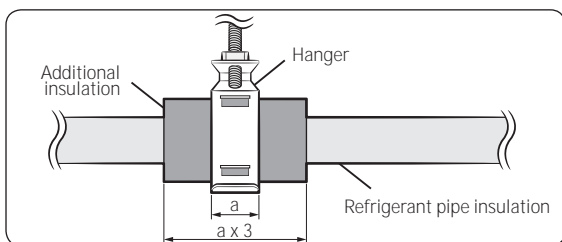

- Must fit tightly against body without any gap.
 - All refrigerant connection must be accessible, in order to permit either unit maintenance or removal.
- 5 Select the insulation of the refrigerant pipe.
- Insulate the gas side and liquid side pipe, noting the insulation thickness that must differ according to the pipe size.
 - Standard: Less than an indoor temperature of 30°C, with humidity at 85%. If installing in a high humidity environment, use one grade thicker insulator by referring to the table below. If installing in an unfavourable environment, use thicker one.
 - The heat-resistance temperature of the insulator must be more than 120°C.

Pipe	Pipe size (mm)	Insulation Type (Heating/Cooling)		Remarks
		Standard [30°C, 85%]	High humidity [30°C, over 85%]	
		EPDM, NBR (mm)		
Liquid pipe	Ø6.35 to Ø9.52	9t	←	Internal temperature is higher than 120°C
	Ø12.7 to Ø50.80	13t	←	
Gas pipe	Ø6.35	13t	19t	
	Ø9.52 to Ø25.40	19t	25t	
	Ø28.58 to Ø44.45		32t	
	Ø50.80	25t	38t	

Installation Procedure

- When installing insulation in the places and conditions below, use the same insulation that is used for high humidity conditions.

<Geological condition>
High humidity locations such as shorelines, hot springs, lake or riversides, and ridges (when part of the building is covered by earth and sand)
<Operation purpose condition>
Restaurant ceiling, sauna, swimming pool etc.
<Building construction condition>
Ceilings frequently exposed to moisture and cooling are not covered. For example, pipes installed at a corridor of a dormitory and studio or near an exit that opens and closes frequently. Places (where the pipes are installed) that are highly humid due to a lack of ventilation.

- Refrigerant pipe before EEV kit and MCU or without EEV kit and MCU
 - You can contact the gas side and liquid side pipes but the pipes should not be pressed.
 - When contacting the gas side and liquid side pipe, use 1 grade thicker insulator.
 - Refrigerant pipe after EEV kit and MCU
 - Install the gas side and liquid side pipes, leave 10mm of space.
 - When contacting the gas side and liquid side pipe, use 1 grade thicker insulator.
- 6 Fix the flexible hose to the drain pipe.
- The connection port of the flexible hose and PVC drain pipe must be fixed with PVC adhesives. Check out that the connected part doesn't leak.

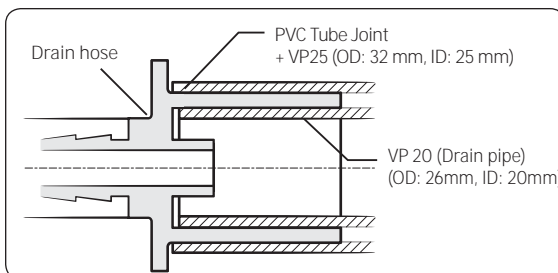

- 7 Connect the flexible hose to the drain hose port.
- Make sure that a rubber ring is installed on the drain hose port.
 - The drain hose port location differs depending on the unit types.

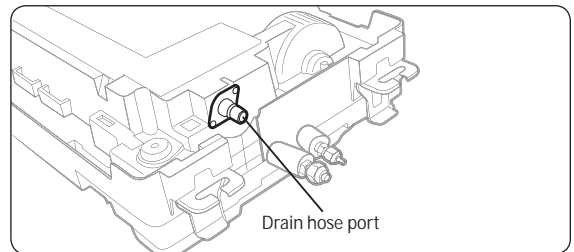

⚠ CAUTION

Check that the indoor unit is level with the ceiling by using the leveller.

- If the slope of the drain pipe is less than 1/100, be sure to install an air vent at the top of each indoor unit to prevent water from flowing back to the unit.
 - If the slope of the drain pipe is 1/100 or more and it is free from backward flow to the indoor unit, you are not required to install an air vent.

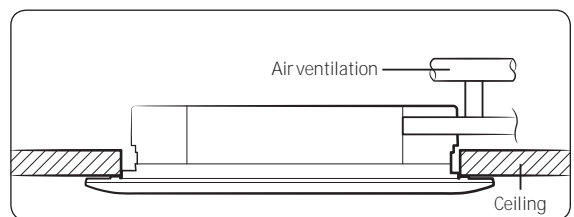

- If it is necessary to increase the height of the drain pipe, install the drain pipe straight within 300 mm from the drain hose port. If it is raised higher than 550 mm, there may be water leaks.

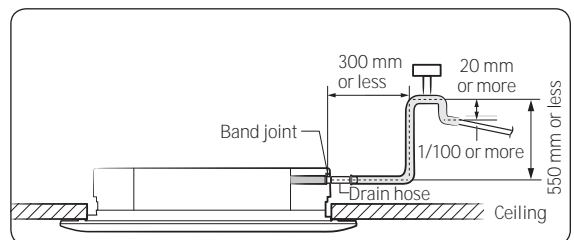

- Do not give the hose an upward gradient beyond the connection port. This will cause water to flow backwards when the unit is stopped, resulting in water leaks.

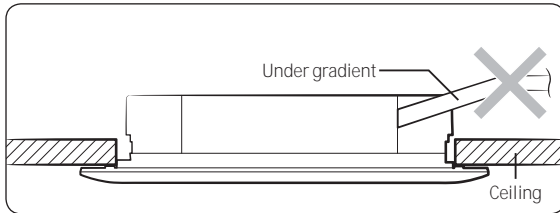

- Do not apply force to the piping on the unit side when connecting the drain hose. The hose should not be allowed to hang loose from its connection to the unit. Fasten the hose to a wall, frame or other support as close to the unit as possible.

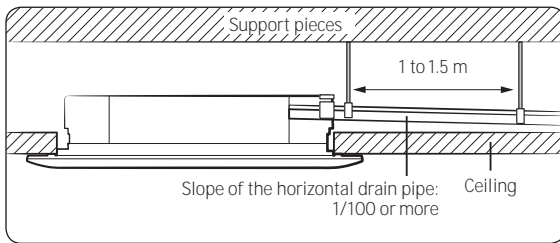

- Install horizontally.

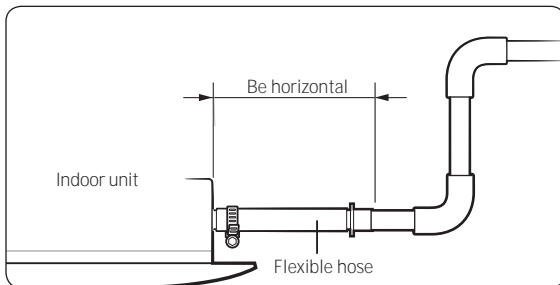

- Max. allowable aixe gap

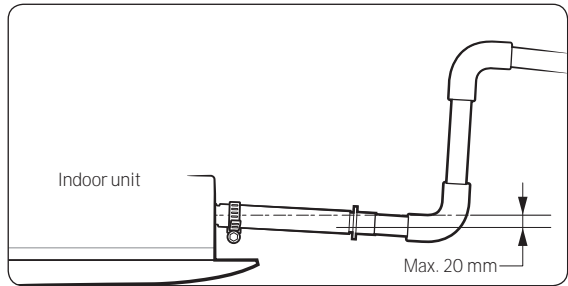

- Max. allowable bending angle

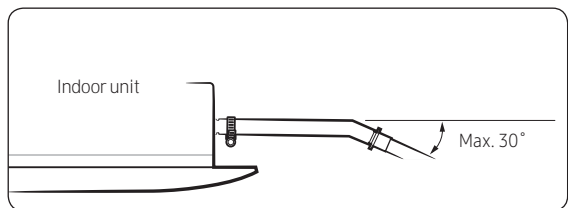

NOTE

- If a concentrated drain pipe is installed, refer to the figure below.

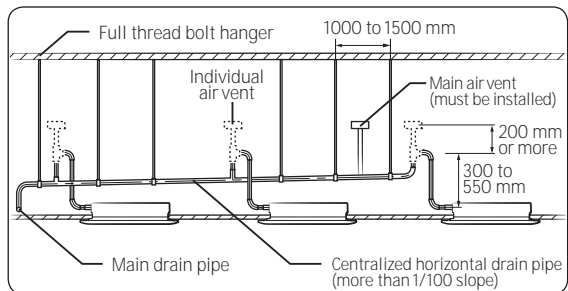

- If 3 or more units are installed, install the main air vent at the front of the farthest indoor unit from the main drain pipe.
- To prevent water from flowing back to indoor units, install an individual air vent at the top of each indoor unit.
 - The air vents should be T or 7 shaped to prevent dust or foreign substances from entering.
 - You may not need to install air vent if the horizontal drain pipe is in proper slope.

Installation Procedure

Step 4 Connecting the power and communication cables

Power and communication cable connection

- Before wiring work, you must turn off all power source.
- Connect the power and communication cable among the units within maximum length to set the voltage drop under 10%.
- The auxiliary circuit breaker (ELCB, MCCB, ELB) should be considered more capacity if many indoor units are connected from one breaker.
- Connect F3, F4(for communication) to the communication cable of the wired remote control.
- Tighten the electric wires with a proper tool within the torque limit to connect and fix them firmly, and then organize the wires to prevent outside pressure being exerted on the covers and other parts. Failure to do so may result in overheating, electric shock, and fire.
- To protect the product from water and possible shock, you should keep the power and the communication cables of the indoor and outdoor units in the iron pipe.
- Connect the power cable to the auxiliary circuit breaker (ELCB, MCCB, ELB).
- Keep distances of 50mm or more between power cable and communication cables.
- Power supply cords of parts of appliances for outdoor use shall not be lighter than polychloroprene sheathed flexible cord. (Code designation IEC:60245 IEC 57 / CENELEC: H05RN-F or IEC:60245 IEC 66 / CENELEC: H07RN-F)
- Screws on terminal block must not be unscrewed with the torque less than 12 kgf•cm.
- When installing the indoor unit in a computer room, use the double shielded (tape aluminum / polyester braid + copper) cable of FROHH2R type.

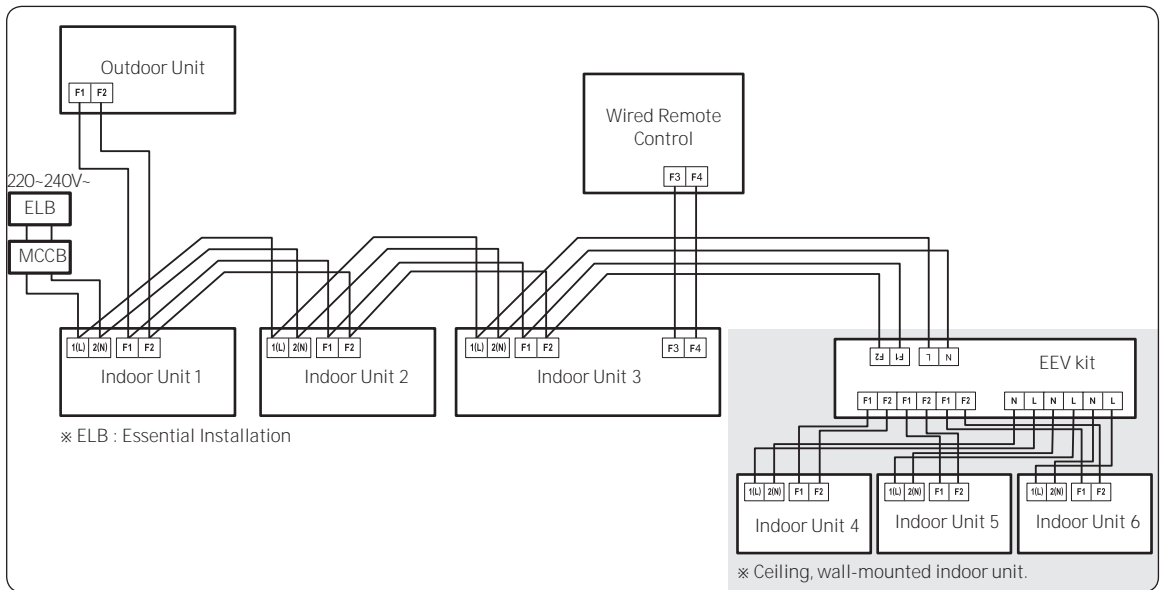

Selecting the crimping terminal lug

- 1 Select the crimping terminal lug based on the nominal dimension of the power cable.
- 2 Cover the connection part of the power cable and crimping terminal lug to insulate it.

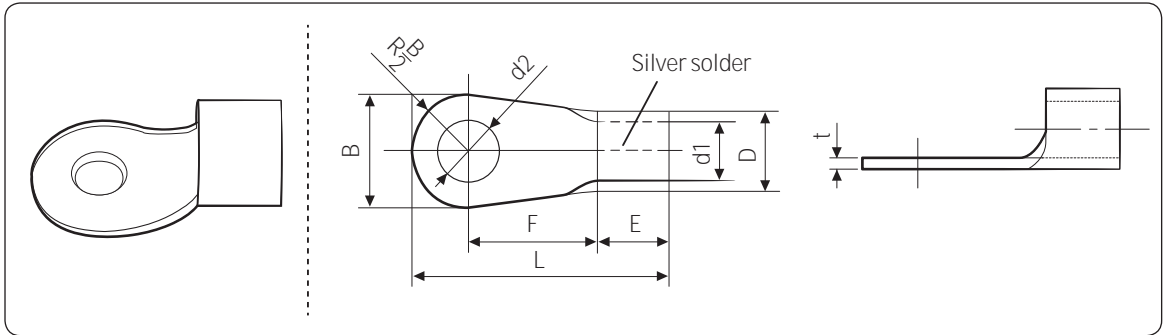

Nominal dimensions for cable (mm ²)	Nominal dimensions for screw (mm)	B		D		d1		E	F	L	d2		t
		Standard dimension (mm)	Allowance (mm)	Standard dimension (mm)	Allowance (mm)	Standard dimension (mm)	Allowance (mm)				Standard dimension (mm)	Allowance (mm)	
1.5	4	6.6	± 0.2	3.4	+0.3 -0.2	1.7	± 0.2	4.1	6	16	4.3	+0.2 0	0.7
	4	8											
2.5	4	6.6	± 0.2	4.2	+0.3 -0.2	2.3	± 0.2	6	6	17.5	4.3	+0.2 0	0.8
	4	8.5											
4	4	9.5	± 0.2	5.6	+0.3 -0.2	3.4	± 0.2	6	5	20	4.3	+0.2 0	0.9

Installation Procedure

Specifications of the terminal blocks

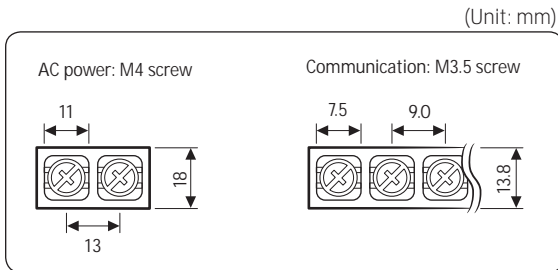

Power supply (single phase)	MCCB	ELB
Min : 198V Max : 242V	XA	XA, 30 mA 0.1 s
Power cable	Earth cable	Communication cable
2.5 mm ² or more	2.5 mm ²	0.75 to 1.5 mm ²

Decide the power cable specification and maximum length by formula 2.

- 1 Decide the capacity of ELB and MCCB by below formula.

$$\text{The capacity of ELB, MCCB } X[\text{A}] = 1.25 \times 1.1 \times \Sigma A_i$$

NOTE

- X : The capacity of ELB, MCCB
- ΣA_i : Sum of rating currents of each indoor unit.

Rated currents

Model	Rating current(A)
AM017NN1PEH*	0.14
AM022NN1PEH*	0.15
AM022NN1DEH*	0.20
AM028NN1DEH*	0.23
AM036NN1DEH*	0.25
AM056NN1DEH*	0.28
AM071NN1DEH*	0.40
AM022NN1DKH*	0.16
AM028NN1DKH*	0.17
AM036NN1DKH*	0.20
AM022NN1DEH2*	0.16
AM028NN1DEH2*	0.17
AM036NN1DEH2*	0.20

- 2 Decide the power cable specification and maximum length within 10% voltage drop among indoor units.

$$\sum_{k=1}^n \left(\frac{\text{Coef} \times 35.6 \times L_k}{1000 \times A_k} \times i_k \right) < 10\% \text{ of input voltage[V]}$$

NOTE

- Coef: 1.55
- L_k: Distance among each indoor unit[m],
- A_k: Power cable specification[mm²]
- i_k: Running current of each unit[A]

Step 5 Setting the indoor unit addresses and the installation options

You cannot set both of the indoor unit addresses and the installation options in a batch: set both of them respectively.

Common steps for setting the addresses and options

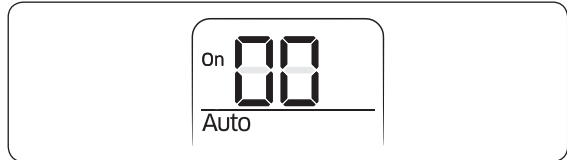
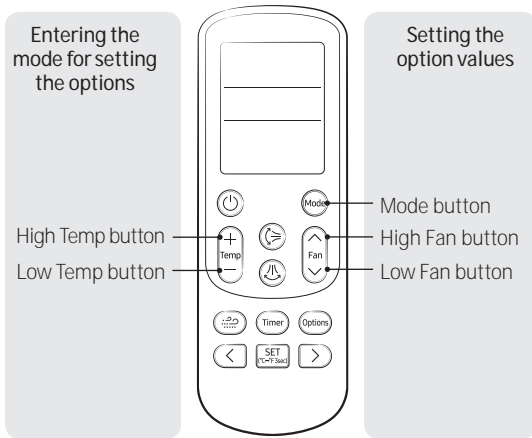

2 Set the option values.

CAUTION

- The total number of available options are 24: SEG1 to SEG24.
- Because SEG1, SEG7, SEG13, and SEG19 are the page options used by the previous remote control models, the modes to set values for these options are skipped automatically.
- Set a 2-digit value for each option pair in the following order: SEG2 and SEG3 → SEG4 and SEG5 → SEG6 and SEG8 → SEG9 and SEG10 → SEG11 and SEG12 → SEG14 and SEG15 → SEG16 and SEG17 → SEG18 and SEG20 → SEG21 and SEG22 → SEG23 and SEG24

NOTE

- The remote control display and buttons may vary depending on the model.

1 Enter the mode for setting the options:

















- Remove the batteries from the remote control, and then insert them again.





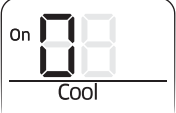
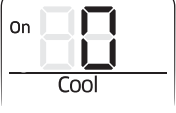











SEG1	SEG2	SEG3	SEG4	SEG5	SEG6
0	X	X	X	X	X
SEG7	SEG8	SEG9	SEG10	SEG11	SEG12
1	X	X	X	X	X
SEG13	SEG14	SEG15	SEG16	SEG17	SEG18
2	X	X	X	X	X
SEG19	SEG20	SEG21	SEG22	SEG23	SEG24
3	X	X	X	X	X

On (SEG1 to SEG12)	Off (SEG13 to SEG24)

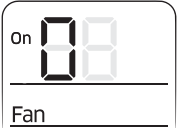

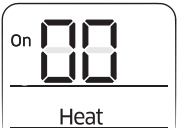



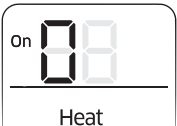
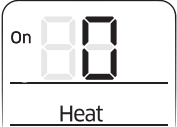









Installation Procedure

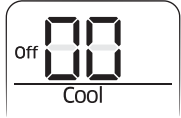



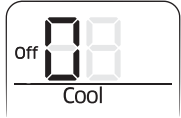
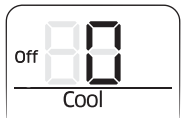



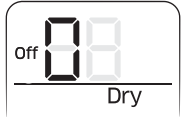







Take the steps presented in the following table:

Steps	Remote control display
<p>1 Set the SEG2 and SEG3 values:</p> <p>a Set the SEG2 value by pressing the  (Low Fan) button repeatedly until the value you want to set appears on the remote control display.</p> <p>b Set the SEG3 value by pressing the  (High Fan) button repeatedly until the value you want to set appears on the remote control display.</p> <p>When you press the  (Low Fan) or  (High Fan) button, values appear in the following order: 0 → 1 → ... E → F</p>	 <p style="text-align: center;">SEG2</p>  <p style="text-align: center;">SEG3</p>
<p>2 Press the  (Mode) button. Cool and On appear on the remote control display.</p>	
<p>3 Set the SEG4 and SEG5 values:</p> <p>a Set the SEG4 value by pressing the  (Low Fan) button repeatedly until the value you want to set appears on the remote control display.</p> <p>b Set the SEG5 value by pressing the  (High Fan) button repeatedly until the value you want to set appears on the remote control display.</p> <p>When you press the  (Low Fan) or  (High Fan) button, values appear in the following order: 0 → 1 → ... E → F</p>	 <p style="text-align: center;">SEG4</p>  <p style="text-align: center;">SEG5</p>
<p>4 Press the  (Mode) button. Dry and On appear on the remote control display.</p>	
<p>5 Set the SEG6 and SEG8 values:</p> <p>a Set the SEG6 value by pressing the  (Low Fan) button repeatedly until the value you want to set appears on the remote control display.</p>	 <p style="text-align: center;">SEG6</p>

Steps	Remote control display
<p>b Set the SEG8 value by pressing the  (High Fan) button repeatedly until the value you want to set appears on the remote control display.</p> <p>When you press the  (Low Fan) or  (High Fan) button, values appear in the following order: 0 → 1 → ... 9 → F</p>	 <p style="text-align: center;">SEG8</p>
<p>6 Press the  (Mode) button. Fan and On appear on the remote control display.</p>	
<p>7 Set the SEG9 and SEG10 values:</p> <p>a Set the SEG9 value by pressing the  (Low Fan) button repeatedly until the value you want to set appears on the remote control display.</p> <p>b Set the SEG10 value by pressing the  (High Fan) button repeatedly until the value you want to set appears on the remote control display.</p> <p>When you press the  (Low Fan) or  (High Fan) button, values appear in the following order: 0 → 1 → ... 9 → F</p>	 <p style="text-align: center;">SEG9</p>  <p style="text-align: center;">SEG10</p>
<p>8 Press the  (Mode) button. Heat and On appear on the remote control display.</p>	
<p>9 Set the SEG11 and SEG12 values:</p> <p>a Set the SEG11 value by pressing the  (Low Fan) button repeatedly until the value you want to set appears on the remote control display.</p> <p>b Set the SEG12 value by pressing the  (High Fan) button repeatedly until the value you want to set appears on the remote control display.</p> <p>When you press the  (Low Fan) or  (High Fan) button, values appear in the following order: 0 → 1 → ... 9 → F</p>	 <p style="text-align: center;">SEG11</p>  <p style="text-align: center;">SEG12</p>

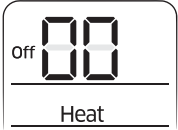
Installation Procedure

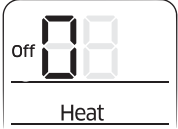
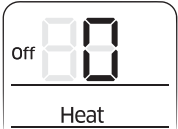

Steps	Remote control display
<p>10 Press the  (Mode) button. Auto and Off appear on the remote control display.</p>	
<p>11 Set the SEG14 and SEG15 values:</p> <p>a Set the SEG14 value by pressing the  (Low Fan) button repeatedly until the value you want to set appears on the remote control display.</p> <p>b Set the SEG15 value by pressing the  (High Fan) button repeatedly until the value you want to set appears on the remote control display.</p> <p>When you press the  (Low Fan) or  (High Fan) button, values appear in the following order: 0 → 1 → ... E → F</p>	 <p style="text-align: center;">SEG14</p>  <p style="text-align: center;">SEG15</p>
<p>12 Press the  (Mode) button. Cool and Off appear on the remote control display.</p>	
<p>13 Set the SEG16 and SEG17 values:</p> <p>a Set the SEG16 value by pressing the  (Low Fan) button repeatedly until the value you want to set appears on the remote control display.</p> <p>b Set the SEG17 value by pressing the  (High Fan) button repeatedly until the value you want to set appears on the remote control display.</p> <p>When you press the  (Low Fan) or  (High Fan) button, values appear in the following order: 0 → 1 → ... E → F</p>	 <p style="text-align: center;">SEG16</p>  <p style="text-align: center;">SEG17</p>
<p>14 Press the  (Mode) button. Dry and Off appear on the remote control display.</p>	
<p>15 Set the SEG18 and SEG20 values:</p> <p>a Set the SEG18 value by pressing the  (Low Fan) button repeatedly until the value you want to set appears on the remote control display.</p>	 <p style="text-align: center;">SEG18</p>

Steps	Remote control display
<p>b Set the SEG20 value by pressing the  (High Fan) button repeatedly until the value you want to set appears on the remote control display.</p> <p>When you press the  (Low Fan) or  (High Fan) button, values appear in the following order: 0 → 1 → ... E → F</p>	 <p style="text-align: center;">SEG20</p>
<p>16 Press the  (Mode) button. Fan and Off appear on the remote control display.</p>	
<p>17 Set the SEG21 and SEG22 values:</p> <p>a Set the SEG21 value by pressing the  (Low Fan) button repeatedly until the value you want to set appears on the remote control display.</p> <p>b Set the SEG22 value by pressing the  (High Fan) button repeatedly until the value you want to set appears on the remote control display.</p> <p>When you press the  (Low Fan) or  (High Fan) button, values appear in the following order: 0 → 1 → ... E → F</p>	 <p style="text-align: center;">SEG21</p>  <p style="text-align: center;">SEG22</p>
<p>18 Press the  (Mode) button. Heat and Off appear on the remote control display.</p>	
<p>19 Set the SEG23 and SEG24 values:</p> <p>a Set the SEG23 value by pressing the  (Low Fan) button repeatedly until the value you want to set appears on the remote control display.</p> <p>b Set the SEG24 value by pressing the  (High Fan) button repeatedly until the value you want to set appears on the remote control display.</p> <p>When you press the  (Low Fan) or  (High Fan) button, values appear in the following order: 0 → 1 → ... E → F</p>	 <p style="text-align: center;">SEG23</p>  <p style="text-align: center;">SEG24</p>

Installation Procedure

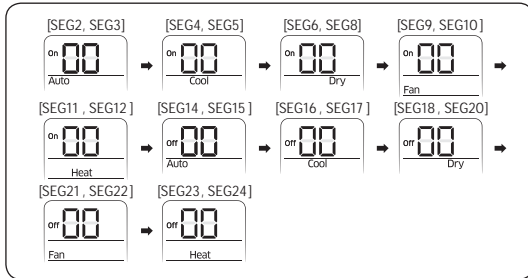
- 3 Check whether the option values that you have set are correct by pressing the  (Mode) button repeatedly



- 4 Save the option values into the indoor unit:
Point the remote control to the remote control sensor on the indoor unit and then press the  (Power) button on the remote control twice. Make sure that this command is received by the indoor unit. When it is successfully received, you can hear a short sound from the indoor unit. If the command is not received, press the  (Power) button again.
- 5 Check whether the air conditioner operates in accordance with the option values you have set:
- Reset the indoor unit by disconnecting and then reconnecting the power cable of the indoor unit or by pressing the RESET button on the outdoor unit.
 - Remove the batteries from the remote control, insert them again, and then press the  (Power) button on the remote control.

Setting the indoor unit addresses (MAIN/RMC/MCU)

- Make sure that the power is supplied to the indoor unit.
 - If the indoor unit is not plugged in, it must include a power supply.
- Make sure that the panel or display is connected to the indoor unit so that it can receive options.

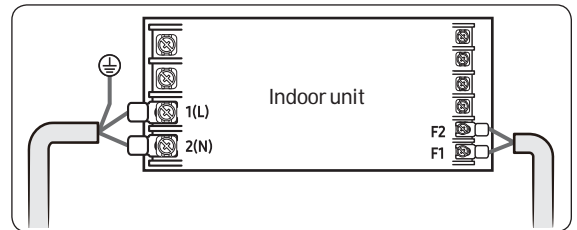

- Set an address (MAIN/RMC/MCU port) for each indoor unit using the remote control, according to your air conditioning system plan.
 - The indoor unit addresses (MAIN/RMC/MCU port) are set to OA0000-100000-200000-300000 by default.

NOTE

- Also set the MCU and Indoor units address by using Add-on → Change address on S-NET Pro 2. (For more information, see the S-NET Pro 2 Help.)
- From SEG13 to SEG18 is for setting MCU address.
 - MCU models that can set address: MCU-S*NEK2N, MCU-S4NEK3N, MCU-S1NEK1N

Option No. for an indoor unit address: OAXXXX-1XXXXX-2XXXXX-3XXXXX

Option	SEG1		SEG2		SEG3		SEG4		SEG5		SEG6	
Function	Page		Mode		Setting main address		100-digit of an indoor unit address		10-digit of an indoor unit address		The single digit of an indoor unit	
Indication and details	Indication	Details	Indication	Details	Indication	Details	Indication	Details	Indication	Details	Indication	Details
		0		A		0	No main address	0 to 9	10-digit	0 to 9	A single digit	0 to 3
					1	Main address setting mode						

Option	SEG7		SEG8	SEG9		SEG10		SEG11		SEG12	
Function	Page		-	Setting RMC address		-		Group channel (x16)		Group address	
Indication and details	Indication	Details	-	Indication	Details	-	-	RMC1	0 to F	RMC2	0 to F
	1			0	No RMC address						
	1			1	RMC address setting mode						
Option	SEG13		SEG14	SEG15		SEG16		SEG17		SEG18	
Function	Page		-	Setting MCU PORT address		10-digit of MCU address		1-digit of MCU		MCU PORT address	
Indication and details	Indication	Details	-	Indication	Details	0-1	10-digit	0-9	1-digit	A-F	PORT Location
	2			0	No MCU PORT						
	1			1	MCU PORT address setting mode						

CAUTION

- If you enter A to F to the SEG5 or SEG6, the indoor unit main address is not changed.
- If you enter 0 to the SEG 3, the indoor unit maintains the previous main address although you enter the option value for the SEG5 or SEG 6.
- If you enter 0 to the SEG 9, the indoor unit maintains previous RMC address although you enter the option value for the SEG11 or SEG12.
- You cannot set the SEG11 or SEG12 to F value at the same time.
- If the indoor unit is connected to the MCU, you can set the SEG 15-18.

Ex.) If you want to set the indoor unit to 'A' port of MCU #1.
(0A0000 – 100000 – 20101A -30000)

Setting the indoor unit installation option (suitable for the condition of each installation location)

- 1 Make sure that the power is supplied to the indoor unit.
 - If the indoor unit is not plugged in, it must include a power supply.
- 2 Make sure that the panel or display is connected to the indoor unit so that it can receive options

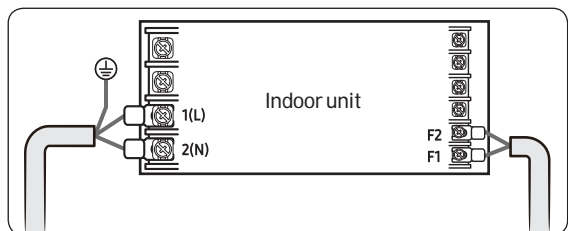

- 3 Set an address for each indoor unit using the remote control, according to your air conditioning system plan.
 - The indoor unit addresses are set to 020010-100000-200000-300000 by default.
 - The SEG20 option, Individual control with remote control, allows you to control multiple indoor units individually by using the remote control.

Installation Procedure

Installation options for the O2 series

SEG1	SEG2	SEG3	SEG4	SEG5	SEG6
0	2	Evaporator Drying	Use of external room temperature sensor / Minimizing fan operation when thermostat is off	Use of central control	FAN RPM compensation
SEG7	SEG8	SEG9	SEG10	SEG11	SEG12
1	Use of drain pump	Use of hot water heater	-	EEV Step when heating stops	Dew removal operation in wind free mode
SEG13	SEG14	SEG15	SEG16	SEG17	SEG18
2	Use of external control	Setting the output of external control / External heater signal / Cooling operation signal / Free Cooling control signal	S-Plasma ion	Buzzer control	Hours of filter usage
SEG19	SEG20	SEG21	SEG22	SEG23	SEG24
3	Individual control of a remote controller	Heating setting compensation / Removing condensate water in heating mode	Adjusted EEV step of stopped unit during oil return /defrost mode.	Motion detect sensor	-

- Even if you set the Use of drain pump (SEG8) option to 0, it is automatically set to 2 (the drain pump is used with 3 minute delay).
- If you set the Maximum filter usage time (SEG18) option to a value other than 2 and 6, it is automatically set to 2 (1000 hours).
- If you set an option to a value that is out of range specified above, the option is automatically set to 0 by default.
- The SEG5 option (Use of central control) is set to 1 (Use) by default. Therefore, you don't need to set the SEG5 option additionally. Note that even if the central control system is not connected, no errors occur. If you want a specific indoor unit not to be controlled by the central control system, set the SEG option of that indoor unit to 0 (Disuse).
- The external output of SEG15 is generated via MIM-B14 connection. (Refer to the manual of MIM-B14.)
- If you set the Individual control with remote control (SEG20) option to a value other than 0 to 4, it is automatically set to 0 (Indoor 1).
- The output of hot water heater in SEG9 is generated from the hot coil part of the terminal board in duct models.

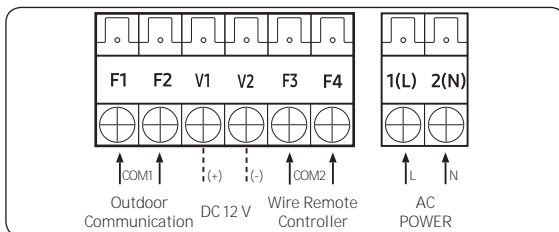

O2 series installation option (Detailed)

Option No. : O2XXXX-1XXXXX-2XXXXX-3XXXXX

Option	SEG1		SEG2		SEG3		SEG4			SEG5		SEG6											
Explanation	PAGE		MODE		Evaporator Drying		Use of external room temperature sensor / Minimizing fan operation when thermostat is off			Use of central control		FAN RPM compensation											
Indication and Details	Indication	Details	Indication	Details	Indication	Details	Indication	Details		Indication	Details	Indication	Details										
								Use of External room temperature sensor	Minimizing fan operation when thermostat is off														
	0			2		0	Disuse	0	Default	Default	0	Disuse	0	Disuse									
								1	Use	Disuse													
								2	Disuse	Use (Heating) (*2)													
						2	Use (5min) (*1)	3	Use	Use (Heating) (*2)	1	Use	1	RPM compensation									
								4	Disuse	Use (Cooling) (*2)													
						4	Use (10min) (*1)	5	Use	Use (Cooling) (*2)	1	Use	2	High ceiling KIT (4way model only)									
								6	Disuse	Use (Heating / Cooling) (*2)													
						4	Use (10min) (*1)	7	Use	Use (Heating / Cooling) (*2)	1	Use	2	High ceiling KIT (4way model only)									
8								Disuse	Use (Cooling Ultra Low Fan) (*2)														
6						Use (30min) (*1)	9	Use	Use (Cooling Ultra Low Fan) (*2)	1	Use	2	High ceiling KIT (4way model only)										
	A	Disuse	Use (Heating / Cooling Ultra Low Fan) (*2)																				
6	Use (30min) (*1)	B	Use	Use (Heating / Cooling Ultra Low Fan) (*2)	1	Use	2	High ceiling KIT (4way model only)															
Option	SEG7		SEG8		SEG9		SEG10			SEG11		SEG12											
Explanation	PAGE		Use of drain pump		Use of hot water heater		-			EEV Step when heating stops		Dew removal operation in wind free mode											
Indication and Details	Indication	Details	Indication	Details	Indication	Details					Indication	Details	Indication	Details									
															1	0	Disuse	0	Disuse	0	Default	0	(Default) Maintain blade status in wind free mode
																1	Use	1	Use (*3)				
2	When an indoor unit stops, drain pump will operate for 3min	3	Use (*3)	1	Adjusted EEV Step setting	1	Cooling operation by opening the blade																

Installation Procedure

Option	SEG13		SEG14		SEG15		SEG16		SEG17		SEG18			
Explanation	PAGE		Use of external control		Setting the output of external control / External heater signal / Cooling operation signal / Free Cooling control signal		S-Plasma ion		Buzzer control		Hours of filter usage			
Indication and Details	Indication	Details	Indication	Details	Indication	Details	Indication	Details	Indication	Details	Indication	Details		
	2	0	Disuse	Normal Signal Control (*4)	0	External control (Thermo On)	0	Disuse	0	Use buzzer	2	1000 Hour		
		1	ON/OFF Control											
		2	OFF Control											
		3	Window ON/OFF Control											
		8	Disuse	Reverse Signal Control (*4)	3	External heater signal (*5)								
		9	ON/OFF Control											
		A	OFF Control											
		B	Window ON/OFF Control											
4	Cooling operation signal (*6)	1	Use	1	Disuse buzzer	6	2000 Hour							
5	Free Cooling control (Cooling Thermo On) (*7)													
6	Free Cooling control (Cooling/Dry Thermo On) (*7)													
Option	SEG19	SEG20		SEG21			SEG22	SEG23		SEG24				
Explanation	PAGE	Individual control of a remote controller		Heating setting compensation / Removing condensate water in heating mode			Adjusted EEV step of stopped unit during oil return /defrost mode.	Motion detect sensor		-				
Indication and Details	Indication	Details	Indication	Details	Indication	Details		Indication	Details	Indication	Details			
	3	0 or 1	channel 1	0	Default	0	Default	0	Default	0	Disuse			
				1	2 °C							1	Turn out in 30min. without motion	
				2	5 °C							2	Turn out in 60min. without motion	
				3	Default							3	Turn out in 120min. without motion	
				4	Use (*8)							4	Turn out in 180min. without motion	
				5	Use (*8)							5	Turn out in 30min. without motion or *advanced function	
		4	channel 2	channel 3	2	5 °C	4	Adjusted EEV position	1	Adjusted EEV position	6	Turn out in 60min. without motion & *advanced function		
					3	Default							7	Turn out in 120min. without motion & *advanced function
					4	2 °C							8	Turn out in 180min. without motion & *advanced function
					5	5 °C							Use (*8)	

* Advanced function: Controlling cooling/heating current or power saving with motion detect.

(*1) When Cooling or dry mode is off. The indoor fan operate in setting minutes.

(*2) Minimizing fan operation when thermostat is off

- Fan operates for 20 seconds at an interval of 5 minutes in heat mode.

- Fan stops or operates Ultra low in Cooling when thermostat is off.

(*3) 1: Fan is turned on continually when the hot water heater is turned on,

3: Fan is turned off when the hot water heater is turned on with cooling only indoor unit

Cooling only indoor unit: To use this option, install the Mode Select switch(MCM-C200) on the outdoor unit and fix it as cool mode.

If the "Cooling Priority" option is set in the Heat Pump outdoor unit, the indoor unit can operate in the Heat mode owing to the water heater even if the outdoor unit is running in the Cool mode.

(*4) When Normal Signal Control is enabled, the external control is turned on by the short-circuit signal and off by the open-circuit signal.

When Reverse Signal Control is enabled, the external control is turned off by the short-circuit signal and on by the open-circuit signal.

(*5) When the following 2 or 3 is used as external heater On/Off signal, the signal for monitoring external contact control will not be output.

2: Fan is turned on continually when the external heater is turned on,

3: Fan is turned off when the external heater is turned on with cooling only indoor unit

Cooling only indoor unit: To use this option, install the Mode Select switch(MCM-C200) on the outdoor unit and fix it as cool mode.

- If Fan is set to off for cooling only indoor unit by setting the SEG9=3 or SEG15=3, you need to use an external sensor or wired remote controller sensor to detect indoor temperature exactly.

- If the "Cooling Priority" option is set in the Heat Pump outdoor unit, the indoor unit can operate in the Heat mode owing to the external heater even if the outdoor unit is running in the Cool mode.

(*6) When indoor unit is in cooling or Dry mode, The output signal is "ON"

(*7) For free cooling control, Economizer controller is required.

(*8) If the air conditioner operates the heating mode immediately after finishing the cooling mode, the condensate water in the drain pan becomes water vapor by the heat of the indoor unit heat exchanger. Since the water vapor might be condensed on the indoor unit, which may fall into a living space, use this function to get rid of the water vapor out of the indoor unit by operating the fan (for maximum 20 minutes) even when the indoor unit is turned off after cooling mode is turned to heating mode.

Installation Procedure

O5 series installation option

SEG1	SEG2	SEG3	SEG4	SEG5	SEG6
0	5	Use of Auto Change Over for HR only in Auto mode / Use of Cooling only indoor unit of HR	(When setting SEG3) Standard heating temp. Offset	(When setting SEG3) Standard cooling temp. Offset	(When setting SEG3) Standard for mode change Heating → Cooling
SEG7	SEG8	SEG9	SEG10	SEG11	SEG12
1	(When setting SEG3) Standard for mode change Cooling → Heating	(When setting SEG3) Time required for mode change (*1)	Compensation option for Long pipe or height difference between indoor units	MTC (*4)	-
SEG13	SEG14	SEG15	SEG16	SEG17	SEG18
2	-	-	-	-	Control variables when using hot water / external heater (*5)
SEG19	SEG20	SEG21	SEG22	SEG23	SEG24
3	-	-	-	Forced FAN Operation for Heating and Cooling	-

05 series installation option (Detailed)

Option No. : 05XXXX-1XXXX-2XXXX-3XXXX

Option	SEG1		SEG2		SEG3		SEG4		SEG5		SEG6	
Explanation	PAGE		MODE		Use of Auto Change Over for HR only in Auto mode / Use of Cooling only indoor unit of HR		(When setting SEG3) Standard heating temp. Offset		(When setting SEG3) Standard cooling temp. Offset		(When setting SEG3) Standard for mode change Heating → Cooling	
Indication and Details	Indication	Details	Indication	Details	Indication	Details	Indication	Details	Indication	Details	Indication	Details
	0		5	0	Follow product option	0	0 °C	0	0 °C	0	1 °C	
						1	0.5 °C	1	0.5 °C	1	1.5 °C	
				1	Use Auto Change Over for HR only	2	1 °C	2	1 °C	2	2 °C	
						3	1.5 °C	3	1.5 °C	3	2.5 °C	
				2	Use Cooling only indoor unit for HR	4	2 °C	4	2 °C	4	3 °C	
						5	2.5 °C	5	2.5 °C	5	3.5 °C	
						6	3 °C	6	3 °C	6	4 °C	
7				3.5 °C	7	3.5 °C	7	4.5 °C				
Option	SEG7		SEG8		SEG9		SEG10		SEG11		SEG12	
Explanation	PAGE		(When setting SEG3) Standard for mode change Cooling → Heating		(When setting SEG3) Time required for mode change (*1)		Compensation option for Long pipe or height difference between indoor units		MTFC (*4)		-	
Indication and Details	Indication	Details	Indication	Details	Indication	Details	Indication	Details	Indication	Details		
	1		0	1 °C	0	5min	0	Default	0	Default		
			1	1.5 °C	1	7min	1	(*2) Height difference is more than 30m or (*3) Distance is longer than 110m				
			2	2 °C	2	9min						
			3	2.5 °C	3	11min						
			4	3 °C	4	13min	2	(*2) Height difference is 15-30m or (*3) Distance is 50-110m				
			5	3.5 °C	5	15min						
			6	4 °C	6	20min						
7			4.5 °C	7	30min	2			Use			

Installation Procedure

Option	SEG13	SEG14	SEG15	SEG16	SEG17	SEG18		
Explanation	-	-	-	-	-	Control variables when using hot water / external heater (*5)		
Indication and Details	Indication	-	-	-	-	-	Details	
	Details						Set temp. for heater On/Off	Delay time for heater On
	0						At the same time as thermo on	No delay
	1						At the same time as thermo on	10 minutes
	2						At the same time as thermo on	20 minutes
	3						1.5 °C	No delay
	4						1.5 °C	10 minutes
	5						1.5 °C	20 minutes
	6						3.0 °C	No delay
	7						3.0 °C	10 minutes
	8						3.0 °C	20 minutes
	9						4.5 °C	No delay
	A						4.5 °C	10 minutes
	B						4.5 °C	20 minutes
	C						6.0 °C	No delay
D	6.0 °C	10 minutes						
E	6.0 °C	20 minutes						
Option	SEG19	SEG20	SEG21	SEG22	SEG23		SEG24	
Explanation	PAGE	-	-	-	Forcing FAN Operation for Heating and Cooling		-	
Indication and Details	Indication	-	-	-	-	-	Details	
	Details						Cooling Fan Setting	Heating Fan Setting
	0						Disuse	Disuse
	1						Disuse	Use (Fan: User setting)
	2						Disuse	Use (Fan: High)
	3						Disuse	Use (Fan: Low)
	4						Use (Fan: User setting)	Disuse
	5						Use (Fan: User setting)	Use (Fan: User setting)
	6						Use (Fan: User setting)	Use (Fan: High)
	7						Use (Fan: User setting)	Use (Fan: Low)
	8						Use (Fan: High)	Disuse
	9						Use (Fan: High)	Use (Fan: User setting)
	A						Use (Fan: High)	Use (Fan: High)
	B						Use (Fan: High)	Use (Fan: Low)
	C						Use (Fan: Low)	Disuse
D	Use (Fan: Low)	Use (Fan: User setting)						
E	Use (Fan: Low)	Use (Fan: High)						
F	Use (Fan: Low)	Use (Fan: Low)						

(* 1) Duration for Auto Change Over triggered when you set dual set points in the Auto mode using the wired remote control MWR-WG00*N.

During the automatic heating operation, if the specified time has elapsed in the state of "the room temperature > the cooling temperature in the Auto mode + the primary cooling temperature (set in the Auto Change Over screen after entering the User mode by pressing the  button on the wired remote control)" the air conditioner changes into the automatic cooling operation.

During the automatic cooling operation, if the specified time has elapsed in the state of "the room temperature < the heating temperature in the Auto mode - the primary heating temperature (set in the Auto Change Over screen after entering the User mode by pressing the  button on the wired remote control)" the air conditioner changes into the automatic heating mode.

(*2) Height difference : The difference of the height between the corresponding indoor unit and the indoor unit installed at the lowest place. For example, When the indoor unit is installed 40m higher than the indoor unit installed at the lowest place, select the option "1".

(*3) The difference between the pipe length of the indoor unit installed at farthest place from an outdoor unit and the pipe length of the corresponding indoor unit from an outdoor unit.

For example, when the farthest pipe length is 100 m and the corresponding indoor unit is 40 m away from an outdoor unit, select the option "2". (100 - 40 = 60m)

(*4) For MTFC option, MTFC(Multi Tenant Function Controller) kit is required.

(*5) Heater operation when the SEG9 of O2 series installation option is set to using hot water heater or when SEG15 is set to using external heater.

Example 1) Setting O2 series SEG9 = "1" / Setting O5 series SEG18 = "0": The hot water heater is turned on at the same time as the heating thermostat is on, and turned off when the heating thermostat is off.

Example 2) Setting O2 series SEG15 = "2" / Setting O5 series SEG18 = "A": Room temp. ≤ set temp. + f (heating compensation temp.)

- External heater is turned on when the temperature is maintained as 4.5 °C for 10 minutes. Room temp. > set temp. + f(heating compensation temp.)
- External heater is turned off when the temperature is maintained as 4.5 °C + 1 °C (1 °C is the Hysteresis for On/Off selection.)

Installation Procedure

Additional information on SEG 3, 4, 5, 6, 8, 9

When SEG 3 is set to 1 and the HR-specific auto changeover function is run, the indoor unit operates as shown in the following figure:

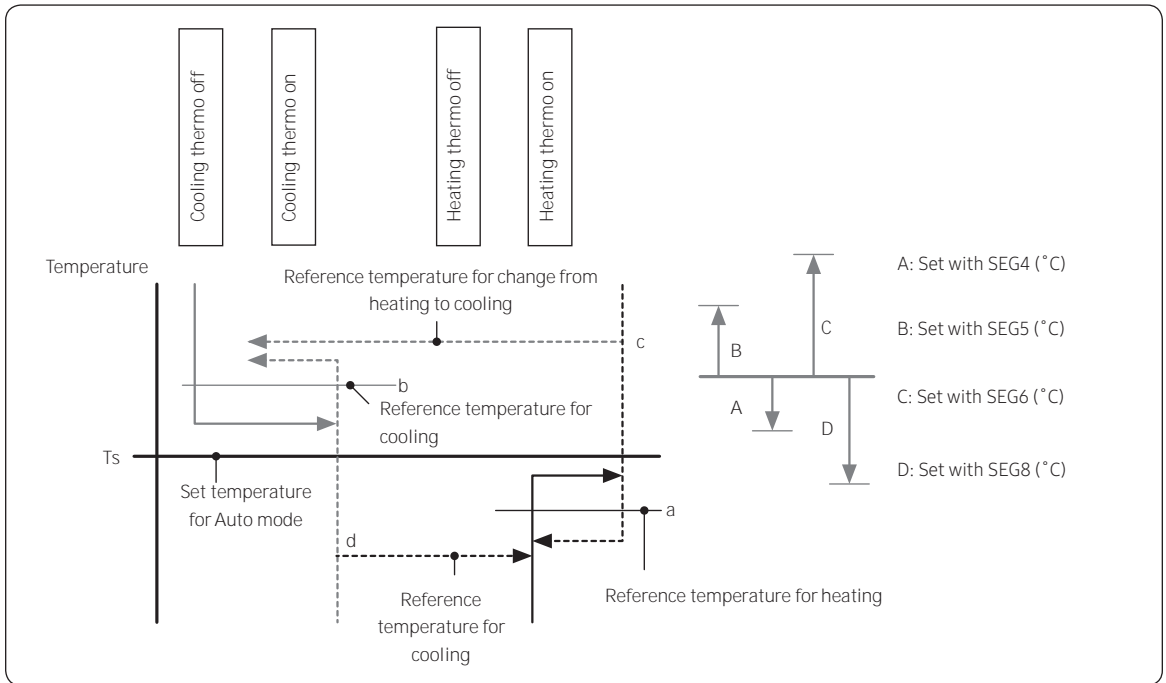

The mode change between the Cool and Heat modes is made only when the thermo off state is maintained for the period of time set with SEG9.

Changing the addresses and options individually

When you want to change the value of a specific option, refer to the following table and follow the steps in **Common steps for setting the addresses and options** on page 31.

Option	SEG1		SEG2		SEG3		SEG4		SEG5		SEG6	
Function	Page		Mode		Type of the option to change		Tens position of the option number		Units position of the option number		New value	
Indication and details	Indication	Details	Indication	Details	Indication	Details	Indication	Details	Indication	Details	Indication	Details
		0		D		Option type	0 to F	Tens position value	0 to 9	Units position value	0 to 9	New value

Example: Changing the Buzzer control (SEG17) option of the installation options to 1 disuse.

Option	SEG1	SEG2	SEG3	SEG4	SEG5	SEG6
Function	Page	Mode	Type of the option to change	Tens position of the option number	Units position of the option number	New value
Indication	0	D	2	1	7	1

CAUTION

- If your indoor units support both cooling and heating, the mixed operation (two or more indoor units operate in different modes simultaneously) is not available when the indoor units are connected to the same outdoor unit. If you set an indoor unit as the master indoor unit by using the remote control, the outdoor unit automatically operate in the current mode of the master indoor unit.

Emergency Temperature Output (ETO) function

CAUTION

- In order to deploy the ETO function, the MIM-B14, an external contact interface module, must be installed in each indoor unit.
 - The ETO is a concept of emergency operation of indoor units. If the indoor unit 1 (main indoor unit) stops because of an error, the indoor unit 2 (sub indoor unit) starts to operate.
 - Basically, the indoor unit 2 operates in the previous mode. [For the first time operation, it starts in 24 °C Auto mode.]
 - To set more detailed operation conditions for the indoor unit 2, use the S-net Pro.

Installation Procedure

Setting up the ETO

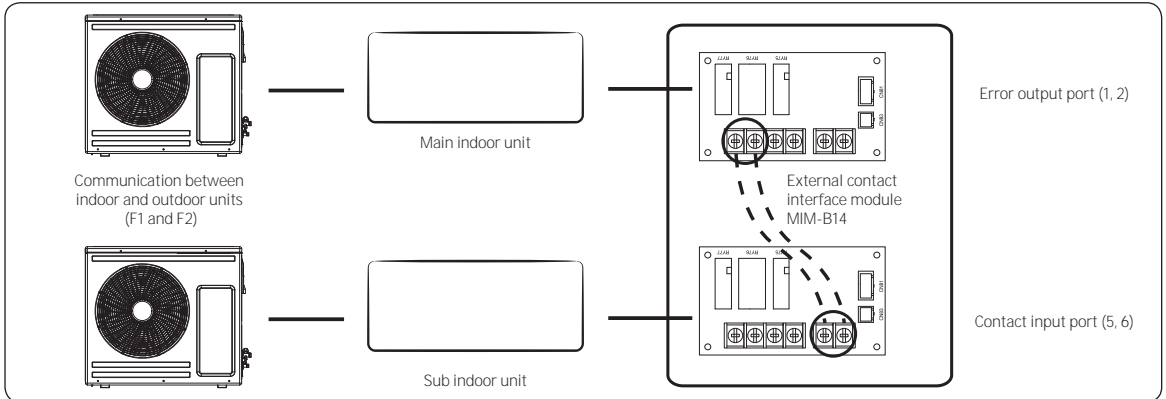

Main indoor unit

- 1 Disable the external contact control (Default).
- 2 Connect the S-net pro2 to F1 and F2.
- 3 Enable the ETO function and set the temperature and time in the S-net pro2.
 - Setting the main indoor unit in the S-net pro2

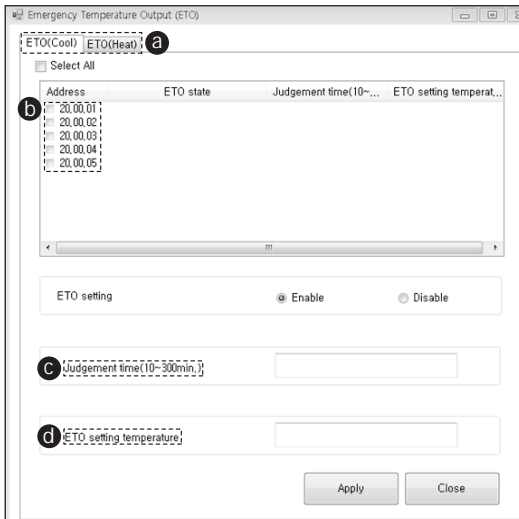

- a Select an emergency temperature output(ETO) mode.
- b Select the main indoor unit.
- c Set the duration used as a reference for generating emergency output.
- d Set the reference temperature at which emergency output is generated.
 - In the Cool mode, emergency output is generated when the room temperature becomes higher than the lower of the set temperature and ETO setting temperature.
 - In the Heat mode, emergency output is generated when the room temperature becomes lower than the higher of the set temperature and ETO setting temperature.

Sub indoor unit (BackUp Unit)

- 1 (Required) Enable the external contact control (with the installation option O2 series SEG14 - Reverse Control).
- 2 Connect the S-net pro2 to F1 and F2.
- 3 Enable the entrance control and set the mode, set temperature, and fan speed in the S-net pro2.
 - Setting the sub indoor unit in the S-net pro2

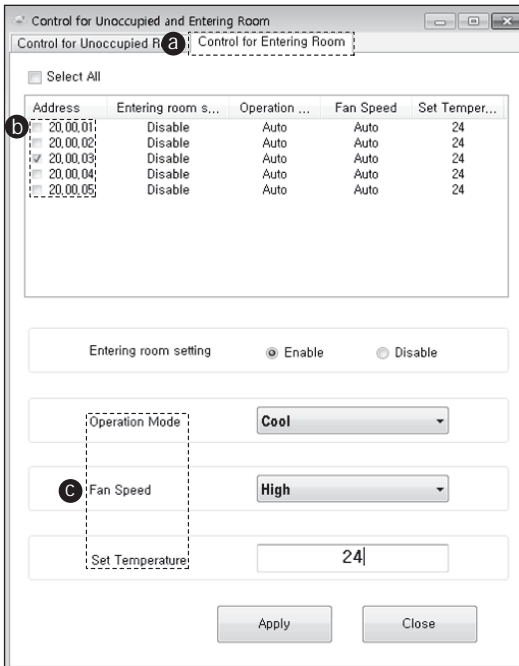

- a Select Control for Entering Room.
- b Select the sub indoor unit.
- c Set the operation mode, fan speed, and set temperature.

- Operation when the external contact settings and the ETO settings overlap

	Enable of ETO	Enable of external contact	Error port output
Main indoor unit	X	X	N/A
	X	O	Output due to an error
	O	X	Output by ETO entrance conditions (temperature / time / error occurrence)
	O	O	Output by ETO entrance conditions (temperature / time / error occurrence) ※ Ready to control the main contact input

	Enable of entrance control	Enable of external contact	Operation when outputting Main
Sub indoor unit	X	X	N/A
	X	O	On with the previous operation conditions
	O	O	On with the entrance control enabled

QUESTIONS OR COMMENTS?

COUNTRY	CALL	OR VISIT US ONLINE AT
UK	0333 000 0333	www.samsung.com/uk/support
IRELAND (EIRE)	0818 717100	www.samsung.com/ie/support
GERMANY	06196 77 555 77	www.samsung.com/de/support
FRANCE	01 48 63 00 00	www.samsung.com/fr/support
SPAIN	91 175 00 15	www.samsung.com/es/support
PORTUGAL	808 207 267	www.samsung.com/pt/support
LUXEMBURG	261 03 710	www.samsung.com/be_fr/support
NETHERLANDS	088 90 90 100	www.samsung.com/nl/support
BELGIUM	02-201-24-18	www.samsung.com/be/support (Dutch) www.samsung.com/be_fr/support (French)
NORWAY	21629099	www.samsung.com/no/support
DENMARK	707 019 70	www.samsung.com/dk/support
FINLAND	030-6227 515	www.samsung.com/fi/support
SWEDEN	0771 726 786	www.samsung.com/se/support
AUSTRIA	0800 72 67 864 (0800-SAMSUNG)	www.samsung.com/at/support
SWITZERLAND	0800 726 786	www.samsung.com/ch/support (German) www.samsung.com/ch_fr/support (French)
HUNGARY	0680SAMSUNG (0680-726-7864)	www.samsung.com/hu/support
CZECH	800 - SAMSUNG (800-726786)	www.samsung.com/cz/support
SLOVAKIA	0800 - SAMSUNG (0800-726 786)	www.samsung.com/sk/support
CROATIA	072 726 786	www.samsung.com/hr/support
BOSNIA	055 233 999	www.samsung.com/ba/support
North Macedonia	023 207 777	www.samsung.com/mk/support
MONTENEGRO	020 405 888	www.samsung.com/support
SLOVENIA	080 697 267 (brezplačna številka)	www.samsung.com/si/support
SERBIA	011 321 6899	www.samsung.com/rs/support
Kosovo	0800 10 10 1	www.samsung.com/support
ALBANIA	045 620 202	www.samsung.com/al/support
BULGARIA	*3000 Цена на един звазкци разговор 0800 111 31 Безплатен за всички оператори	www.samsung.com/bg/support
ROMANIA	*8000 (apel in retea) 08008-726-78-64 (08008-SAMSUNG) Apel GRATUIT Atenție: Dacă efectuați apelul din rețeaua Digi (RCS/RDS), vă rugăm să ne contactați formând numărul Telverde fără ultimele două cifre, astfel: 0800872678.	www.samsung.com/ro/support
ITALIA	800-SAMSUNG (800.7267864)	www.samsung.com/it/support
CYPRUS	8009 4000 only from landline, toll free	www.samsung.com/gr/support
GREECE	80111-SAMSUNG (80111 726 7864) only from land line (+30) 210 6897691 from mobile and land line	
POLAND	801-172-678* lub +48 22 607-93-33* * (opłata według taryfy operatora)	http://www.samsung.com/pl/support/
LITHUANIA	8-800-77777	www.samsung.com/lt/support
LATVIA	8000-7267	www.samsung.com/lv/support
ESTONIA	800-7267	www.samsung.com/ee/support

Samsung, PO Box 12987, Blackrock, Co. Dublin. Ireland
or Blackbushe Business Park, Yateley, GU46 6GG. UK

