

Damper actuator in the IP66/67 protective housing for adjusting dampers in HVAC plants, comparable industrial plants and technical building installations

- Air damper size up to approx. 3.2 m<sup>2</sup>
- Torque motor 16 Nm
- Nominal voltage AC/DC 24 V
- Control Open/close (unsuitable for 3-point controls)
- Running time motor 7 s
- Optimum weather protection for use outdoors (for use in ambient temperatures up to -40°C, there is a separate actuator available with built-in heater)

**Technical data**

<b>Electrical data</b>	Nominal voltage	AC/DC 24 V
	Nominal voltage frequency	50/60 Hz
	Nominal voltage range	AC 19.2...28.8 V / DC 21.6...28.8 V
	Power consumption in operation	15 W
	Power consumption in rest position	2 W
	Power consumption for wire sizing	26 VA
	Connection supply / control	Cable 1 m, 3 x 0.75 mm <sup>2</sup> (halogen-free)
	Parallel operation	Yes (note the performance data)
<b>Functional data</b>	Torque motor	16 Nm
	Direction of motion motor	selectable with switch 0 (ccw rotation) / 1 (cw rotation)
	Manual override	with push-button, can be locked (under protective housing)
	Angle of rotation	Max. 95°
	Angle of rotation note	can be limited on both sides with adjustable mechanical end stops
	Minimum angle of rotation	Min. 30°
	Running time motor	7 s / 90°
	Sound power level, motor	63 dB(A)
	Mechanical interface	Universal shaft clamp 12...26.7 mm
	Position indication	Mechanical, pluggable
<b>Safety data</b>	Protection class IEC/EN	III, Safety Extra-Low Voltage (SELV)
	Power source UL	Class 2 Supply
	Degree of protection IEC/EN	IP66/67
	Degree of protection NEMA/UL	NEMA 4X
	Enclosure	UL Enclosure Type 4X
	EMC	CE according to 2014/30/EU
	Certification IEC/EN	IEC/EN 60730-1 and IEC/EN 60730-2-14
	UL Approval	cULus according to UL60730-1A, UL60730-2-14 and CAN/CSA E60730-1 The UL marking on the actuator depends on the production site, the device is UL-compliant in any case
	Type of action	Type 1
	Rated impulse voltage supply / control	0.8 kV
	Pollution degree	4
	Ambient humidity	Max. 100% RH
	Ambient temperature	-30...40°C [-22...104°F]

<b>Safety data</b>	Ambient temperature note	Caution: +40...+50°C utilisation possible only under certain restrictions. Please contact your supplier.
	Storage temperature	-40...80°C [-40...176°F]
	Servicing	maintenance-free
<b>Weight</b>	Weight	3.6 kg

**Safety notes**

- This device has been designed for use in stationary heating, ventilation and air-conditioning systems and must not be used outside the specified field of application, especially in aircraft or in any other airborne means of transport.
- Only authorised specialists may carry out installation. All applicable legal or institutional installation regulations must be complied during installation.
- Junction boxes must at least correspond with enclosure IP degree of protection!
- The cover of the protective housing may be opened for adjustment and servicing. When it is closed afterwards, the housing must seal tight (see installation instructions).
- The device may only be opened at the manufacturer's site. It does not contain any parts that can be replaced or repaired by the user.
- The cables must not be removed from the device installed in the interior.
- Self adaptation is necessary when the system is commissioned and after each adjustment of the angle of rotation (press the adaptation push-button once).
- To calculate the torque required, the specifications supplied by the damper manufacturers concerning the cross-section, the design, the installation situation and the ventilation conditions must be observed.
- The device contains electrical and electronic components and must not be disposed of as household refuse. All locally valid regulations and requirements must be observed.
- The device is not designed for applications where chemical influences (gases, fluids) are present or for utilisation in corrosive environments in general.
- The actuator may not be used in plenary applications (e.g. suspended ceilings or raised floors).
- The materials used may be subject to external influences (temperature, pressure, construction fastening, effect of chemical substances, etc.), which cannot be simulated in laboratory tests or field trials. In case of doubt, we definitely recommend that you carry out a test. This information does not imply any legal entitlement. Belimo will not be held liable and will provide no warranty.
- Flexible metallic cable conduits or threaded cable conduits of equal value are to be used for UL (NEMA) Type 4X applications.
- When used under high UV loads, e.g. extreme sunlight, the use of flexible metallic or equivalent cable conduits is recommended.

**Product features**

<b>Fields of application</b>	The actuator is particularly suitable for utilisation in outdoor applications and is protected against the following weather conditions: - UV radiation - Rain / Snow - Dirt / Dust - Air humidity - Alternating climate / frequent and severe temperature fluctuations (Recommendation: use the actuator with integrated factory-installed heating which can be ordered separately to prevent internal condensation)
<b>Simple direct mounting</b>	Simple direct mounting on the damper shaft with a universal shaft clamp, supplied with an anti-rotation device to prevent the actuator from rotating.
<b>Manual override</b>	Manual override with push-button possible (the gear train is disengaged for as long as the button is pressed or remains locked). The housing cover must be removed for manual override.

- Adjustable angle of rotation** Adjustable angle of rotation with mechanical end stops. A minimum permissible angle of rotation of 30° must be allowed for. The housing cover must be removed to set the angle of rotation.
- High functional reliability** The actuator is overload protected, requires no limit switches and automatically stops when the end stop is reached.
- Home position** The first time the supply voltage is switched on, i.e. at the time of commissioning, the actuator carries out an adaptation, which is when the operating range and position feedback adjust themselves to the mechanical setting range.  
The detection of the mechanical end stops enables a gentle approach to the end positions, thus protecting the actuator mechanics.  
The actuator then moves into the position defined by the control signal.

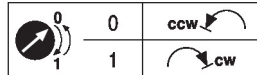
**Accessories**

Electrical accessories	Description	Type
	Auxiliary switch 2 x SPDT add-on, grey	S2A GR
	Feedback potentiometer 140 Ω add-on	P140A
	Feedback potentiometer 200 Ω add-on	P200A
	Feedback potentiometer 500 Ω add-on	P500A
	Feedback potentiometer 1 kΩ add-on	P1000A
	Feedback potentiometer 2.8 kΩ add-on	P2800A
	Feedback potentiometer 5 kΩ add-on	P5000A
	Feedback potentiometer 10 kΩ add-on	P10000A
Mechanical accessories	Description	Type
	Cable gland for cable diameter Ø 4...10 mm	Z-KB-PG11
Options ex works only	Description	Type
	Heater, with adjustable thermostat	HT24-MG
	Heater, with mechanical humidistat	HH24-MG

**Electrical installation**



**Supply from isolating transformer.**  
**Parallel connection of other actuators possible. Observe the performance data.**

**Wire colours:**

- 1 = black
- 2 = red
- 3 = white

**Wiring diagrams**

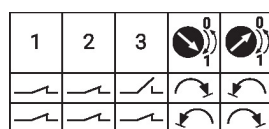
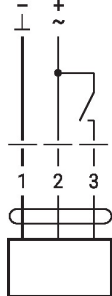
AC/DC 24 V, open/close



Operating controls and indicators

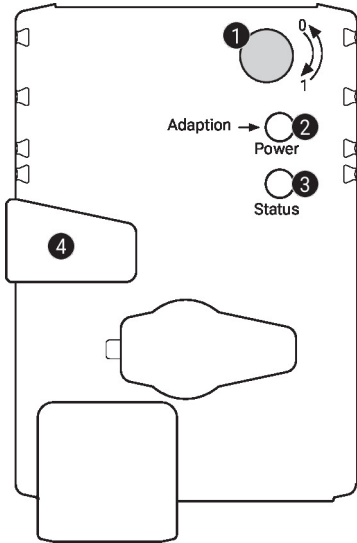

**1 Direction of rotation switch**

Switch over: Direction of rotation changes

**2 Push-button and LED display green**

Off: No power supply or malfunction  
 On: In operation  
 Press button: Triggers angle of rotation adaptation, followed by standard mode

**3 Push-button and LED display yellow**

Off: Standard mode  
 On: Adaptation or synchronisation process active  
 Press button: No function

**4 Manual override button**

Press button: Gear train disengages, motor stops, manual override possible  
 Release button: Gear train engages, synchronisation starts, followed by standard mode

**Check power supply connection**

**2** Off and **3** On Possible wiring error in power supply

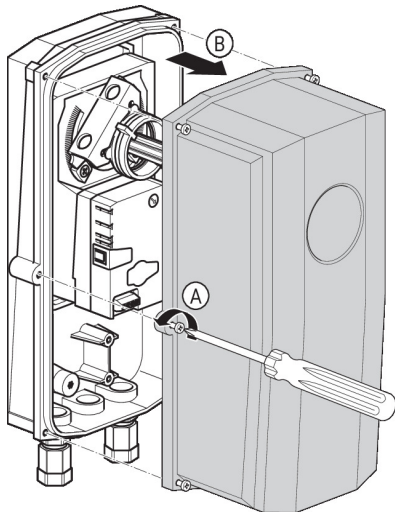



Installation notes



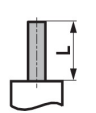

**Negative torque** Max. 50% of the torque (Caution: Application possible only with restrictions. Please contact your supplier.)

Dimensions

Spindle length

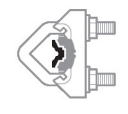
	-
	16...75

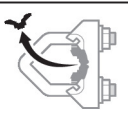
Clamping range

		
	12...22	12...18
		
	22...26.7	12...18

