

CBD/EC



Double inlet centrifugal fans, direct motor EC Technology IE4 with integrated electronics and forward curved impeller



EC TECHNOLOGY MOTOR with integrated electronics



EC CONTROL
Supplied as an optional accessory

Double inlet centrifugal fans, direct motor EC Technology IE4 with integrated electronics and forward curved impeller, specially designed for high energy efficiency.

Fan:

- Galvanized steel sheet casing.
- Forward curved impeller in galvanized sheet steel.

Motor:

- High efficiency EC Technology motors with integrated electronics, regulated by 0-10 V.
- IE4 efficiency motors, class F and IP54 protection.
- Single-phase 190-250 V 50/60 Hz.
- Working temperature: -25 °C +60 °C.

- CPC: Constant pressure control.
- CFC: Constant flow control.
- DAY / NIGHT: Double pressure setpoint adjustment according to time of day.
- External sensor: compatible with temperature, humidity, air quality or CO sensor.
- Equipment preconfigured in constant pressure mode with 100 Pa setpoint.

Finish:

- Anti-corrosive in galvanized steel sheet.

EC CONTROL: Supplied as an optional accessory. Control panel for ventilation systems with EC Technology motors with the electronics integrated in the motor itself. With the following characteristics:



High quality, extremely robust impeller, dynamically balanced in accordance with ISO 21940-11

Order code

CBD/EC	—	2525	—	4M	—	3/4	—	IE4
↓		↓		↓	↓	↓		↓
CBD/EC: Double inlet centrifugal fans, direct motor EC Technology IE4 with integrated electronics and forward curved impeller		Impeller size mm mm inch 1919 7/7 2525 9/9 2828 10/10 3333 12/12		Number of motor poles 4=1400 r/min 50 Hz 6=900 r/min 50 Hz	M = Single-phase	Motor power (HP)		IE4 motor

Technical characteristics

Model	Equivalence inches	Max. speed (r/min)	Maximum admissible current (A) 230V	Max. electric power (kW)	Maximum flow rate (m³/h)	Sound pressure level dB (A)	Approx. weight (Kg)	According ErP *
CBD/EC-1919-4M-1/5 IE4	7/7	1400	1.65	0.18	1520	59	9	Excluded
CBD/EC-1919-6M-1/10 IE4	7/7	900	0.98	0.09	1374	53	9	Excluded
CBD/EC-2525-4M-1/2 IE4	9/9	1400	1.64	0.37	2400	66	10	2020
CBD/EC-2525-4M-3/4 IE4	9/9	1400	2.37	0.55	3200	70	11	2020
CBD/EC-2525-4M-1 IE4	9/9	1400	3.12	0.75	4200	71	12	2020
CBD/EC-2525-6M-1/3 IE4	9/9	900	1.07	0.25	2785	62	11	2020
CBD/EC-2828-4M-1 IE4	10/10	1400	4.12	0.75	3827	72	13	2020
CBD/EC-2828-4M-2 IE4	10/10	1410	11.04	1.50	5915	74	15	2020
CBD/EC-2828-6M-1/3 IE4	10/10	900	1.10	0.25	3046	62	13	2020
CBD/EC-3333-6M-1 IE4	12/12	900	7.83	1.10	5200	71	21	2020

* In accordance with the ErP 2020 draft



Erp. (Energy Related Products)

Information on Directive 2009/125/EC can be downloaded from the SODECA website or the QuickFan selector programme.

Acoustic characteristics

The indicated values are determined by measuring the sound pressure level and sound power in dB(A) obtained in a free field at a distance equivalent to twice the size of the fan plus the impeller diameter, with a minimum of 1.5 m.

Sound power spectrum Lw(A) in dB(A) per Hz frequency band

	63	125	250	500	1000	2000	4000	8000		63	125	250	500	1000	2000	4000	8000
1919-4M-1/5 IE4	29	44	55	63	65	64	63	55	2525-6M-1/3 IE4	32	47	58	66	68	67	66	58
1919-6M-1/10 IE4	23	38	49	57	59	58	57	49	2828-4M-1 IE4	42	57	68	76	78	77	76	68
2525-4M-1/2 IE4	36	51	62	70	72	71	70	62	2828-4M-2 IE4	44	59	70	78	80	79	78	70
2525-4M-3/4 IE4	40	55	66	74	76	75	74	66	2828-6M-1/3 IE4	32	47	58	66	68	67	66	58
2525-4M-1 IE4	41	56	67	75	77	76	75	67	3333-6M-1 IE4	41	56	67	75	77	76	75	67

Dimensions mm

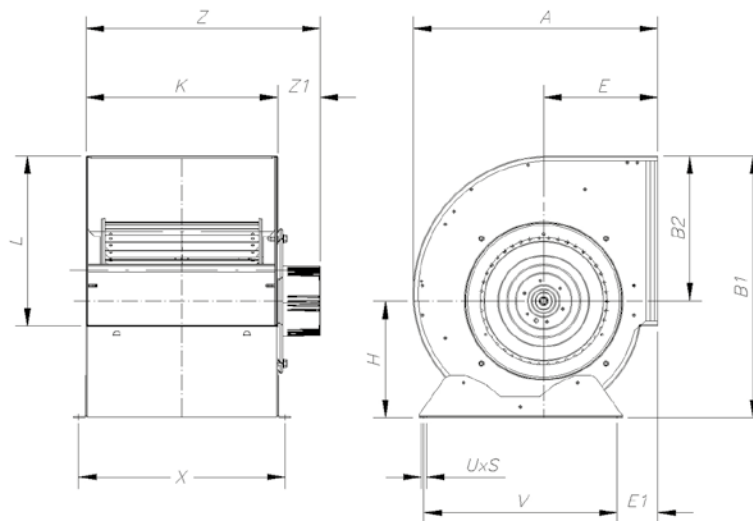

	Equivalence inches	A	B1	B2	E	E1	H	K	L	UxS	V	X	Z1	Z
CBD/EC-1919	7/7	315	333	189	152	64	144	230	208	9x16	225	258	35	265
CBD/EC-2525	9/9	380	400	218	183	78	182	300	263	9x16	275	328	85	385
CBD/EC-2828	10/10	422	450	246	202	73	204	326	292	9x16	315	352	55	381
CBD/EC-3333	12/12	493	526	290	230	82	236	387	345	9x16	390	415	85	472

Accessories



INT



EC CONTROL



MTP



SI-PRESIÓN



SI-TEMP IND



SI-MF



SI-CO2 IND



SI-HUMEDAD

Characteristic curves

Q= Flow rate in m³/h, m³/s and cfm

Pe= Static pressure in mm H₂O, Pa and inwg

1919-4M-1/5 IE4

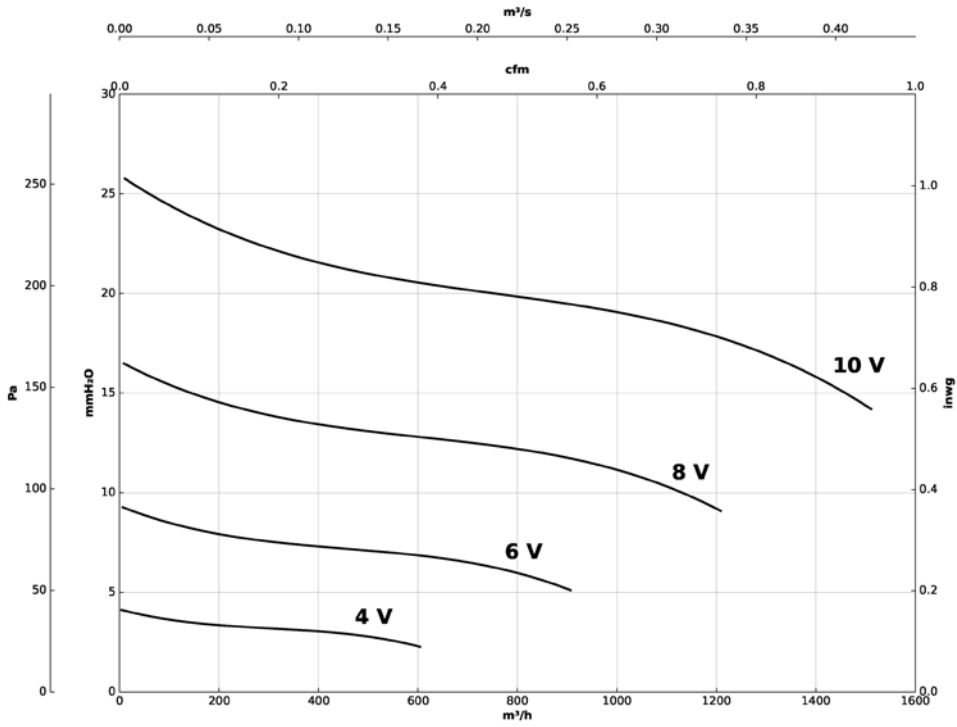

1919-6M-1/10 IE4

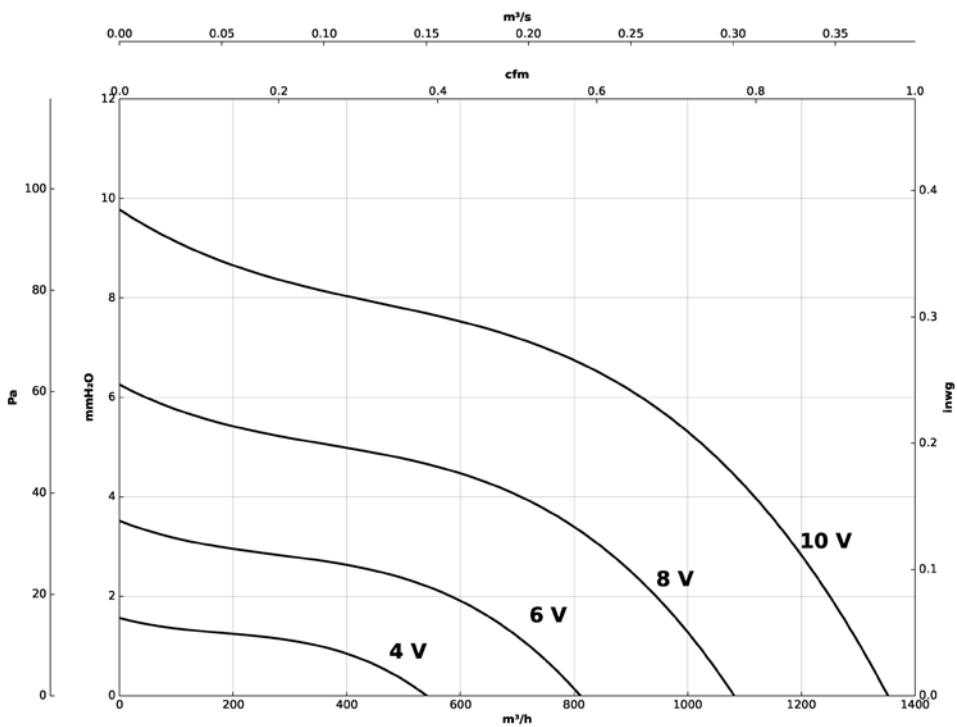

Characteristic curves

Q= Flow rate in m³/h, m³/s and cfm

Pe= Static pressure in mm H₂O, Pa and inwg

2525-4M-1/2 IE4

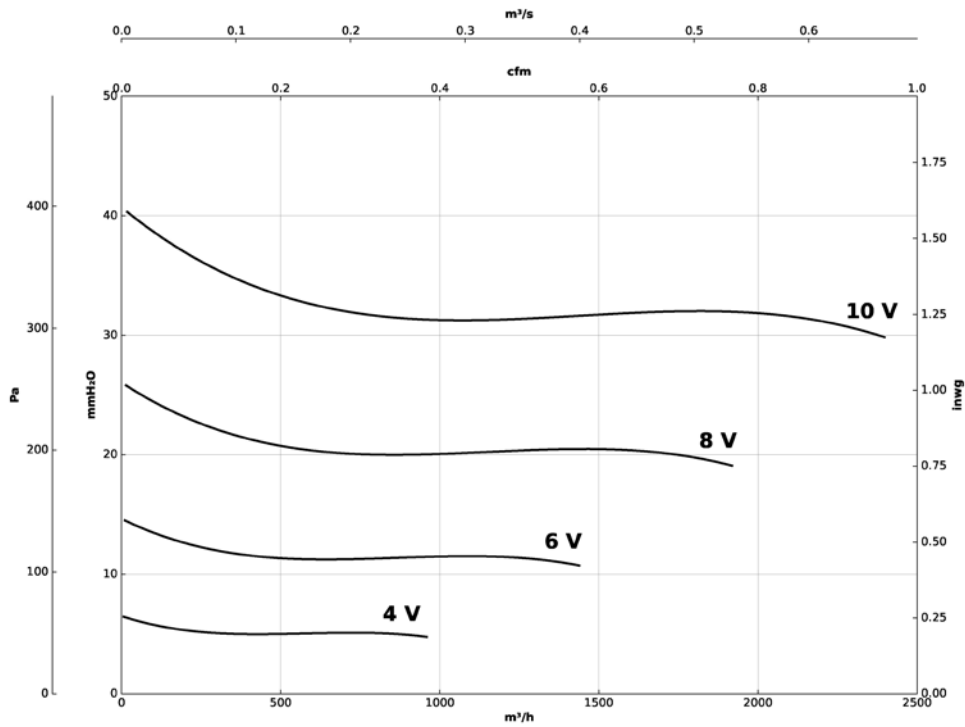

2525-4M-3/4 IE4

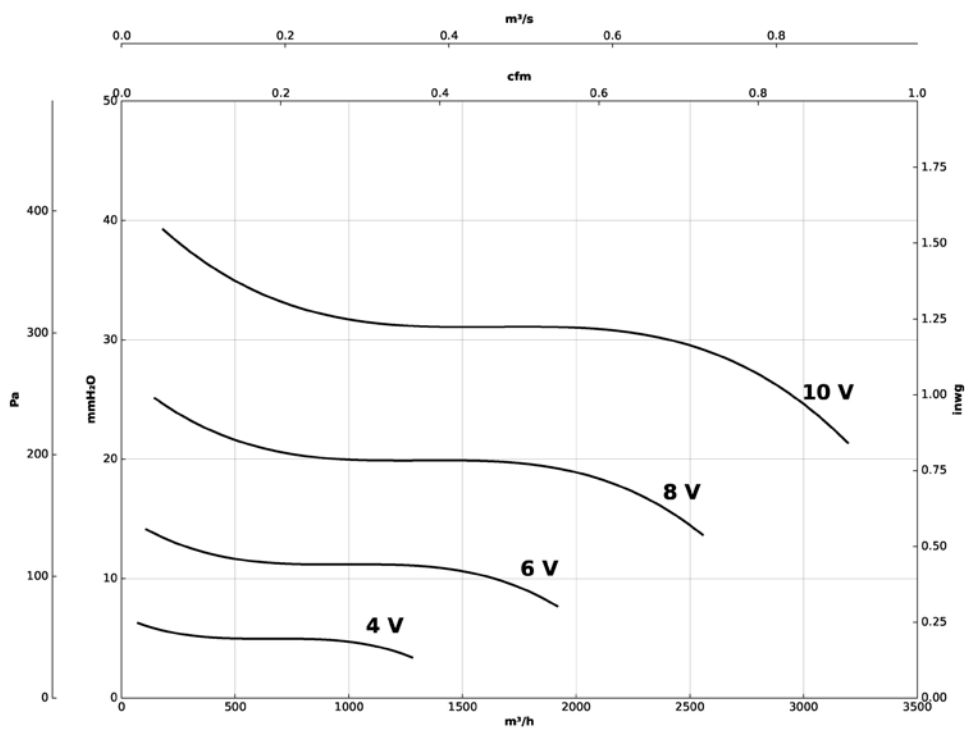

Characteristic curves

Q= Flow rate in m³/h, m³/s and cfm

Pe= Static pressure in mm H₂O, Pa and inwg

2525-4M-1 IE4

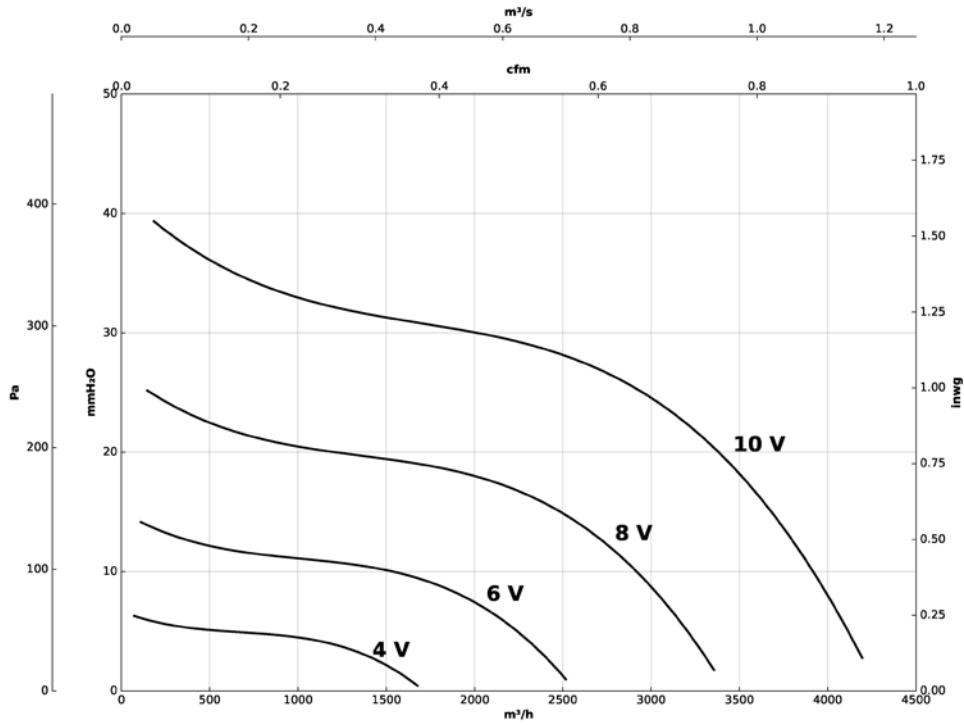

2525-6M-1/3 IE4

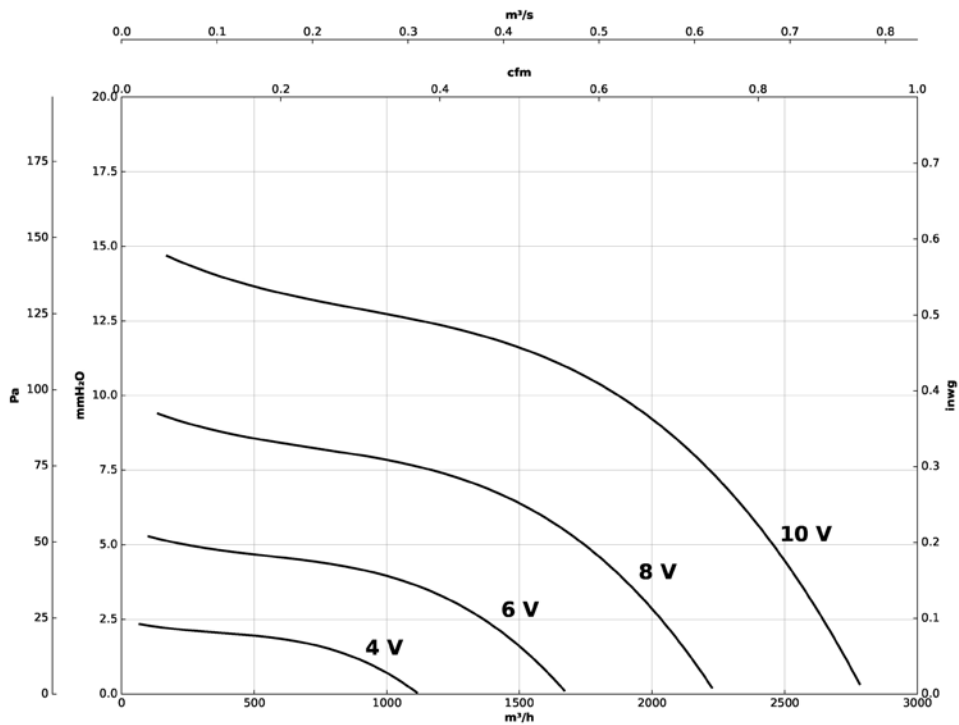

Characteristic curves

Q= Flow rate in m³/h, m³/s and cfm

Pe= Static pressure in mm H₂O, Pa and inwg

2828-4M-1 IE4

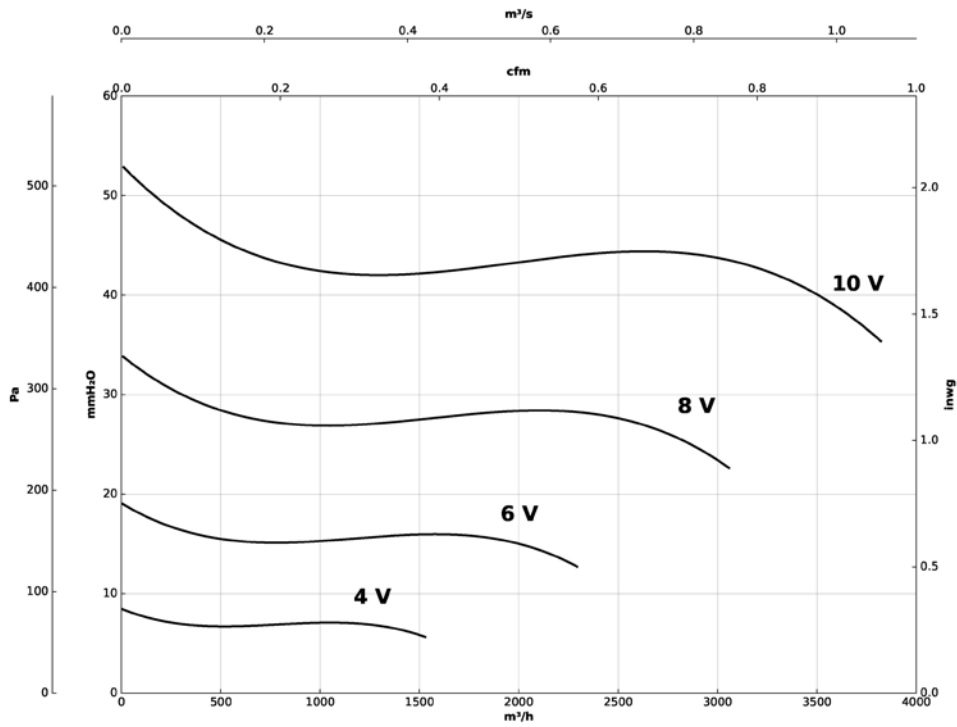

2828-4M-2 IE4

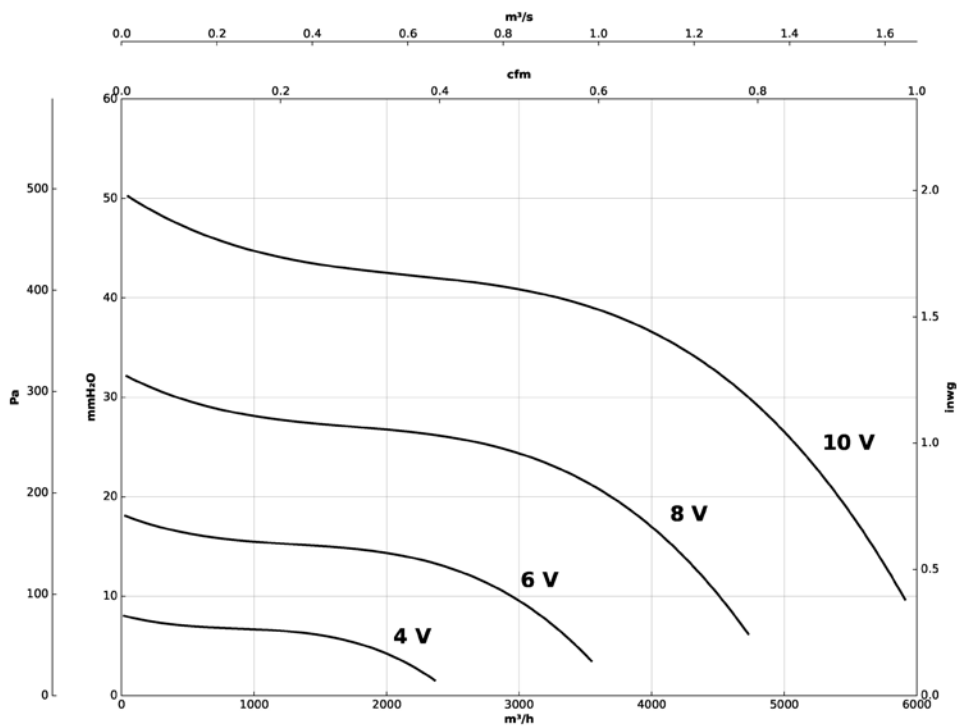

Characteristic curves

Q= Flow rate in m³/h, m³/s and cfm

Pe= Static pressure in mm H₂O, Pa and inwg

2828-6M-1/3 IE4

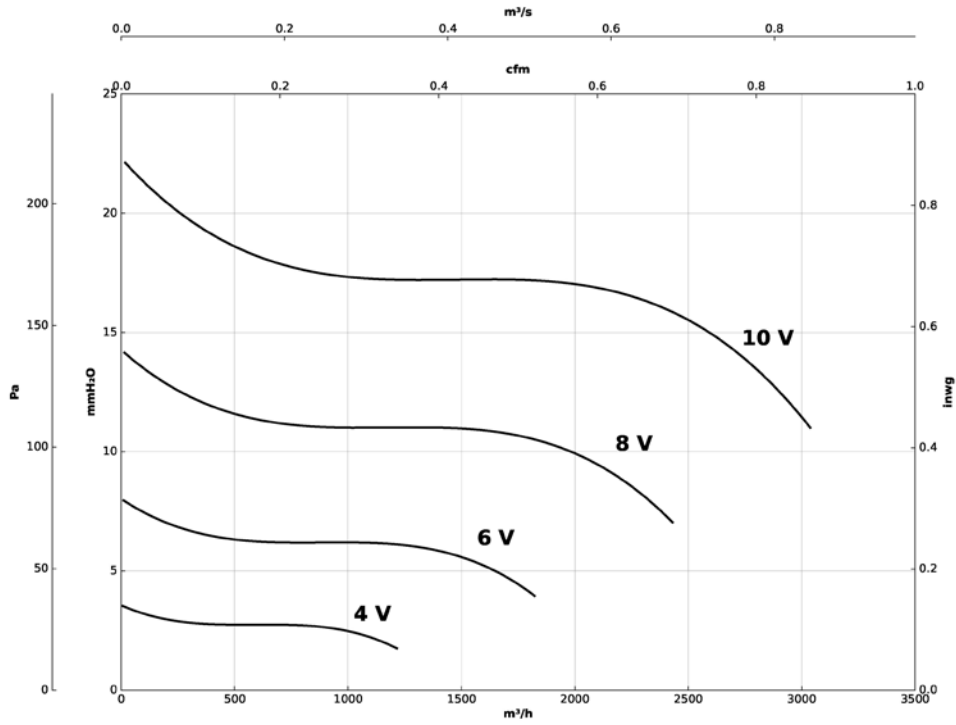

3333-6M-1 IE4

