



Range of low profile plate mounted axial fans fitted with plastic impellers with fiberglass, single phase motor (HCFB) or three phase motor (HCFT), IP65 (1), Class F insulation (2), equipped with thermal protection (3).

(1) Ø 800, 900 and 1000 models are IP55.

(2) Working temperatures from -40°C up to +70°C. Except models 4-710 suitable up to +55°C and models Ø 800 to 1000 suitable for usage in environments from -20°C to +40°C.

(3) Except models 800 to 1000.

**Motors**

Available, depending upon the model, with single or three phase motors in 2, 4 or 6 poles.

All motors are speed controllable by autotransformer except 2 pole and /4-630, 710, T/800, T/900 and T/1000.

Three phase models are speed controllable by inverter.

Electrical supplies:

Single phase 220-240V-50Hz.

{Capacitor located inside the wiring terminal box}.

Three phase 220-240/380-415V-50Hz or 380-415V-50Hz.

{See characteristic chart}.

**Additional information**

Standard air direction: form (A) configuration.

{Motor over Impeller}.

**On request**

Inlet finger proof guard for models Ø 800 to 1000.

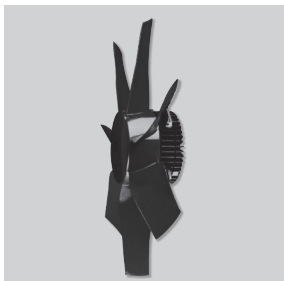

**Compact design**

Compact design created by the combination of the motor with the factory matched direct drive wrap around impeller hub.

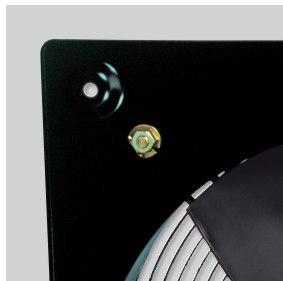

**Corrosion resistance**

Mounting plate, motor support and finger proof guard protected by cataforesis primer and black polyester paint finish. Stainless steel screws.

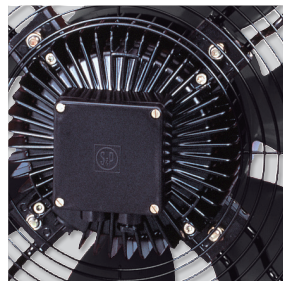

**Terminal box**

Wiring terminal box with cable gland PG-11.

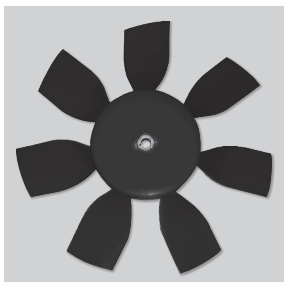

**Impeller dynamically balanced**

Impellers are dynamically balanced, according to ISO 1940 standard, giving vibration free operation.

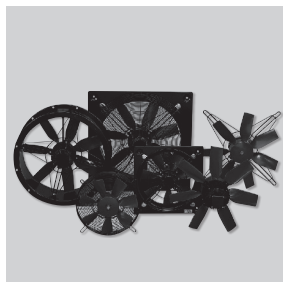

**Manufacturing variations**

Multiple manufacturing variations, depending on the type of installation and use conditions.



**Configuration for models Ø 800 to 1000**

Special design of motor over impeller, which provides compactness and tightness IP55.



Range of low profile plate mounted axial fans fitted with aluminium impellers and single phase motor (HCBB) or three phase motor (HCBT), IP65 (1), Class F insulation (2), equipped with thermal protection (3).  
 (1) Models 800, 900 and 1000 are IP55.  
 (2) Working temperatures from -40°C up to +70°C. Except models 4-710 suitable up to +55°C and models Ø 800, 900 and 1000 suitable for usage in environments from -20°C to +40°C.  
 (3) Except models Ø 800 to 1000.

**Motors**

Available, depending upon the model, with single or three phase motors in 4 or 6 poles. All motors are speed controllable by autotransformer except models /4-630, B/710, T/4-710, T/800, T/900 and T/1000. Three phase models are speed controllable by inverter.  
 Electrical supplies:  
 Single phase 220-240V-50Hz.  
 (Capacitor located inside the wiring terminal box).  
 Three phase 220-240/380-415V-50Hz or 380-415V-50Hz.  
 (See characteristic chart).

**Additional information**

Standard air direction: form (A) configuration. (Motor over Impeller).

**On request**

Inlet finger proof guard for models Ø 800 to 1000.

**ATEX Versions HCBT**

On request, explosion proof versions in accordance with ATEX Directive, for three phase models.  
 - Motors IP55, Class F  
 - ATEX Flameproof-Gas  
 In standard ATEX version flameproof motors are without thermal protection.  
 If used with frequency inverter, flameproof motors with a PTC-type thermal protection must be specified at order.  
 For models 800 to 1000mm  
 Ⓜ II 2G Ex d IIB T4  
 Ⓜ II 2G Ex d IIB+H2 T4 (with Ex d IIC T4)  
 - ATEX Increased safety-Gas  
 Except models HCBB/ 4-250, HCBB/ 6-355, HCBB/ 6-400  
 Available model HCBB/ 6-400 with 230/400 V motor  
 Available models to HCBB-1000  
 Ⓜ II 2G Ex e II T3  
 - ATEX Dust  
 In standard ATEX version, ATEX motors for dust are without thermal protection.  
 If used with frequency inverter, ATEX motors for dust with a PTC-type thermal protection must be specified at order.  
 For models 800 to 1000mm  
 Suspended flammable particles and non-conductive dust:  
 Ⓜ II 3D Ex tc IIB T125°C  
 Conductive dust:  
 Ⓜ II 3D Ex tc IIC T125°C (with IP65 motor)  
 Working temperatures for ATEX versions:  
 -20°C to +55°C  
 models HCBB/4-315 to HCBB/4-710  
 models HCBB/6-450 to HCBB 6-710  
 -20°C to +40°C  
 model HCBB/4-800 to 1000  
 model HCBB/6-800 to 1000  
 To select HCBB ATEX refer to Easyvent.  
 Note electrical data may vary for ATEX motors.

**Specific applications**



Versions



PROTECTION

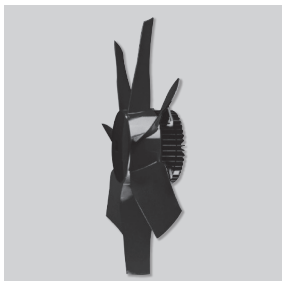

**Compact design**

Compact design created by the combination of the motor with the factory matched direct drive wrap around impeller hub.

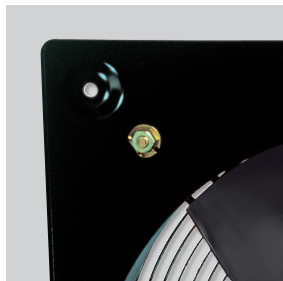

**Corrosion resistance**

Mounting plate, motor support and finger proof guard protected by cataforesis primer and black polyester paint finish. Stainless steel screws.

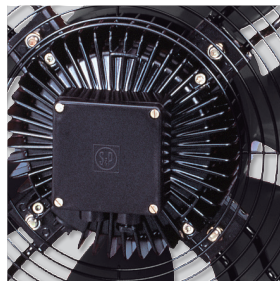

**Terminal box**

Wiring terminal box with cable gland PG-11.

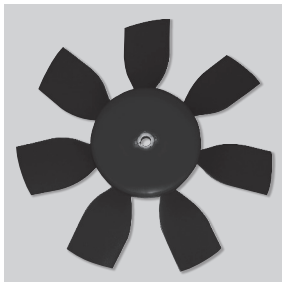

**Impeller dynamically balanced**

Impellers are dynamically balanced, according to ISO 1940 standard, giving vibration free operation.

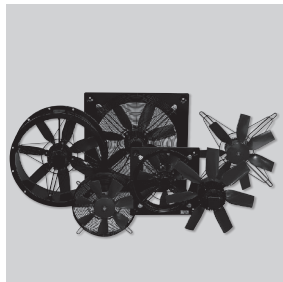

**Manufacturing variations**

Multiple manufacturing variations, depending on the type of installation and use conditions.



**Configuration for models Ø 800 to 1000**

Special design of motor over impeller, which provides compactness and tightness IP55.

**TECHNICAL CHARACTERISTICS WITH PLASTIC IMPELLERS**

Before making any electrical connection ensure that the voltage and frequency of the mains electrical supply matches that of the fan data plate label.

Model	Speed (r.p.m.)	Diameter (mm)	Maximum absorbed power (W)	Maximum current (A)		Sound pressure level* (dB(A))	Maximum airflow (m <sup>3</sup> /h)	Weight (kg)	Speed controller		Inverter control	
				230 V	400 V				REB	RMT**	VFTM**	VFKB**
SINGLE PHASE 2 POLE												
HCGB/2-315/I	2690	315	336	1,5	-	63	3.150	7	-	-	-	-
HCGB/2-355/I	2730	355	392	1,7	-	68	3.550	8	-	-	-	-
SINGLE PHASE 4 POLE												
HCFB/4-250/H	1380	250	77	0,3	-	49	1.090	5	REB-1	-	-	-
HCFB/4-315/H	1340	315	125	0,6	-	55	2.220	7	REB-1	-	-	-
HCFB/4-355/H	1415	355	168	0,7	-	59	3.470	8	REB-2,5	-	-	-
HCFB/4-400/H	1420	400	271	1,2	-	62	4.920	9	REB-2,5	-	-	-
HCFB/4-450/H	1380	450	471	2,0	-	65	6.830	13	REB-2,5	-	-	-
HCFB/4-500/H	1400	500	671	2,9	-	68	9.140	16	REB-5	-	-	-
HCFB/4-560/H	1410	560	1102	4,7	-	70	12.980	22	-	-	-	-
HCFB/4-630/H	1380	630	1573	7,1	-	73	17.230	25	-	-	-	-
SINGLE PHASE 6 POLE												
HCFB/6-315/H	990	315	80	0,4	-	45	1.620	7	REB-1	-	-	-
HCFB/6-355/H	920	355	81	0,4	-	48	2.250	8	REB-1	-	-	-
HCFB/6-400/H	885	400	100	0,4	-	51	2.980	9	REB-1	-	-	-
HCFB/6-450/H	920	450	103	0,7	-	54	3.510	13	REB-2,5	-	-	-
HCFB/6-500/H	920	500	224	1,0	-	57	6.030	16	REB-2,5	-	-	-
HCFB/6-560/H	905	560	321	1,3	-	59	8.180	22	REB-2,5	-	-	-
HCFB/6-630/H	915	630	469	2,0	-	62	11.000	25	REB-5	-	-	-
THREE PHASE 2 POLE												
HCGT/2-315/L	2630	315	461	1,4	0,81	68	3.790	7	-	-	VFTM-Tri 0,37	VFKB-45
HCGT/2-355/I	2570	355	497	1,46	0,85	71	4.490	8	-	-	VFTM-Tri 0,37	VFKB-45
THREE PHASE 4 POLE												
HCFT/4-250/H	1365	250	73	0,3	0,2	49	1.110	5	-	RMT-1,5	VFTM-Tri 0,37	VFKB-45
HCFT/4-315/H	1340	315	124	0,5	0,3	55	2.170	7	-	RMT-1,5	VFTM-Tri 0,37	VFKB-45
HCFT/4-355/H	1385	355	171	0,9	0,5	59	3.550	8	-	RMT-1,5	VFTM-Tri 0,37	VFKB-45
HCFT/4-400/H	1370	400	250	1,0	0,6	62	4.790	9	-	RMT-1,5	VFTM-Tri 0,37	VFKB-45
HCFT/4-450/H	1380	450	449	1,4	0,8	65	6.640	13	-	RMT-1,5	VFTM-Tri 0,37	VFKB-45
HCFT/4-500/H	1460	500	767	3,5	2,0	68	9.750	16	-	RMT-2,5	VFTM-Tri 0,75	VFKB-45
HCFT/4-560/H	1390	560	1051	3,8	2,2	70	12.500	22	-	RMT-2,5	VFTM-Tri 0,75	VFKB-45
HCFT/4-630/H	1425	630	1582	5,0	2,9	73	17.900	25	-	-	VFTM-Tri 1,1	VFKB-45
HCFT/4-710/H	1375	710	2413	7,4	4,3	74	22.140	27	-	-	VFTM-Tri 2,2	VFKB-45
HCFT/4-800/L-X-1,5	1420	800	2308	6,6	3,8	78	22.780	37	-	-	VFTM-Tri 1,5	VFKB-45
HCFT/4-800/H-X-3	1450	800	4344	12,5	7,2	84	33.410	52	-	-	VFTM-Tri 4	VFKB-48
HCFT/4-900/L-X-3	1460	900	3845	11,3	6,5	82	25.550	61	-	-	VFTM-Tri 3	VFKB-48
HCFT/4-900/H-X-5,5	1460	900	7090	-	12,3	87	45.550	95	-	-	VFTM-Tri 5,5	-
HCFT/4-1000/L-X-3	1440	1000	5098	14,2	8,2	86	38.800	67	-	-	VFTM-Tri 3	VFKB-48
HCFT/4-1000/H-X-7,5	1470	1000	8228	-	13,7	93	53.000	100	-	-	VFTM-Tri 7,5	-
THREE PHASE 6 POLE												
HCFT/6-355/H	925	355	83	0,3	0,2	48	2.260	8	-	RMT-1,5	VFTM-Tri 0,37	VFKB-45
HCFT/6-400/H	880	400	107	0,5	0,3	51	3.070	9	-	RMT-1,5	VFTM-Tri 0,37	VFKB-45
HCFT/6-450/H	910	450	146	0,5	0,3	54	4.440	13	-	RMT-1,5	VFTM-Tri 0,37	VFKB-45
HCFT/6-500/H	920	500	240	1,0	0,6	57	6.350	16	-	RMT-1,5	VFTM-Tri 0,37	VFKB-45
HCFT/6-560/H	925	560	337	1,2	0,7	59	8.320	22	-	RMT-1,5	VFTM-Tri 0,37	VFKB-45
HCFT/6-630/H	920	630	534	2,1	1,2	62	11.400	25	-	RMT-1,5	VFTM-Tri 0,37	VFKB-45
HCFT/6-710/H	955	710	888	4,5	2,6	65	16.260	27	-	RMT-5	VFTM-Tri 1,5	VFKB-45
HCFT/6-800/L-X-0,55	940	800	1042	3,5	2,0	73	18.310	31	-	-	VFTM-Tri 0,75	VFKB 45
HCFT/6-800/H-X-0,75	945	800	1160	3,8	2,2	75	19.960	36	-	-	VFTM-Tri 1,1	VFKB 45
HCFT/6-900/L-X-1,1	965	900	1266	4,7	2,7	74	23.160	53	-	-	VFTM-Tri 1,5	VFKB 45
HCFT/6-900/H-X-1,5	955	900	2202	7,1	4,1	78	31.720	56	-	-	VFTM-Tri 1,5	VFKB 45
HCFT/6-1000/L-X-1,1	940	1000	1749	5,7	3,3	79	28.970	54	-	-	VFTM-Tri 1,5	VFKB 45
HCFT/6-1000/H-X-1,5	945	1000	2627	8,1	4,7	84	37.980	59	-	-	VFTM-Tri 2,2	VFKB 45

\* Sound pressure level measured in free field conditions at a distance equivalent to three times the diameter of the impeller with a minimum of 1,5 meters.

\*\* Three phase speed controllers (RMT) or inverter control (VFKB/VFTM): three phase 400V.

**TECHNICAL CHARACTERISTICS WITH ALUMINIUM IMPELLERS**

Before making any electrical connection ensure that the voltage and frequency of the mains electrical supply matches that of the fan data plate label.

Model	Speed (r.p.m.)	Diameter (mm)	Maximum absorbed power (W)	Maximum current (A)		Sound pressure level* (dB(A))	Maximum airflow (m <sup>3</sup> /h)	Weight (kg)	Speed controller		Inverter control	
				230 V	400 V				REB	RMT**	VFTM**	VFKB**
SINGLE PHASE 4 POLE												
HCBB/4-250/H	1325	250	84	0,4	–	49	1.130	5	REB-1	–	–	–
HCBB/4-315/H	1235	315	124	0,7	–	55	2.220	7	REB-1	–	–	–
HCBB/4-355/H	1385	355	193	0,9	–	59	3.590	8	REB-2,5	–	–	–
HCBB/4-400/H	1360	400	315	1,5	–	62	4.830	9	REB-2,5	–	–	–
HCBB/4-450/H	1410	450	626	2,8	–	65	7.180	13	REB-5	–	–	–
HCBB/4-500/H	1370	500	762	3,3	–	68	8.850	16	REB-5	–	–	–
HCBB/4-560/H	1390	560	1433	6,5	–	70	13.400	22	REB-10	–	–	–
HCBB/4-630/H	1360	630	1879	8,3	–	71	16.720	25	–	–	–	–
SINGLE PHASE 6 POLE												
HCBB/6-355/H	900	355	84	0,4	–	48	2.230	8	REB-1	–	–	–
HCBB/6-400/H	845	400	112	0,5	–	51	3.010	9	REB-1	–	–	–
HCBB/6-450/H	935	450	191	0,8	–	54	4.400	13	REB-2,5	–	–	–
HCBB/6-500/H	915	500	244	1,1	–	57	5.620	16	REB-2,5	–	–	–
HCBB/6-560/H	930	560	449	1,9	–	59	8.950	22	REB-2,5	–	–	–
HCBB/6-630/H	915	630	588	2,9	–	62	10.950	25	REB-5	–	–	–
THREE PHASE 4 POLE												
HCBT/4-250/H	1330	250	81	0,3	0,2	49	1.120	5	–	RMT-1,5	VFTM-Tri 0,37	VFKB-45
HCBT/4-315/H	1330	315	125	0,5	0,3	55	2.380	7	–	RMT-1,5	VFTM-Tri 0,37	VFKB-45
HCBT/4-355/H	1380	355	181	0,8	0,5	59	3.530	8	–	RMT-1,5	VFTM-Tri 0,37	VFKB-45
HCBT/4-400/H	1340	400	283	1,2	0,7	62	5.020	9	–	RMT-1,5	VFTM-Tri 0,37	VFKB-45
HCBT/4-450/H	1350	450	547	1,7	1,0	65	6.800	13	–	RMT-1,5	VFTM-Tri 0,37	VFKB-45
HCBT/4-500/H	1390	500	809	2,7	1,6	68	9.140	16	–	RMT-2,5	VFTM-Tri 0,55	VFKB-45
HCBT/4-560/H	1390	560	1287	4,0	2,3	70	12.950	22	–	RMT-2,5	VFTM-Tri 0,75	VFKB-45
HCBT/4-630/H	1385	630	1736	5,4	3,1	73	16.840	25	–	–	VFTM-Tri 1,1	VFKB-45
HCBT/4-710/H	1350	710	2554	7,6	4,4	74	22.400	27	–	–	VFTM-Tri 2,2	VFKB-45
HCBT/4-800/L-X-1,5	1410	800	2632	7,3	4,2	78	23.290	37	–	–	VFTM-Tri 1,5	VFKB-45
HCBT/4-800/H-X-3	1440	800	4595	12,8	7,4	84	33.100	52	–	–	VFTM-Tri 4	VFKB-48
HCBT/4-900/L-X-3	1450	900	3909	12,0	6,9	82	34.270	62	–	–	VFTM-Tri 3	VFKB-48
HCBT/4-900/H-X-5,5	1455	900	7893	–	13,4	87	46.270	96	–	–	VFTM-Tri 5,5	–
HCBT/4-1000/L-X-3	1415	1000	5048	14,2	8,2	86	39.910	67	–	–	VFTM-Tri 4	VFKB-48
HCBT/4-1000/H-X-7,5	1470	1000	8675	–	14,6	93	53.700	101	–	–	VFTM-Tri 7,5	–
THREE PHASE 6 POLE												
HCBT/6-355/H	900	355	91	0,3	0,2	48	2.270	8	–	RMT-1,5	VFTM-Tri 0,37	VFKB-45
HCBT/6-400/H	840	400	120	0,5	0,3	51	3.050	9	–	RMT-1,5	VFTM-Tri 0,37	VFKB-45
HCBT/6-450/H	925	450	198	0,9	0,5	54	4.620	13	–	RMT-1,5	VFTM-Tri 0,37	VFKB-45
HCBT/6-500/H	905	500	282	1,1	0,6	57	6.190	16	–	RMT-1,5	VFTM-Tri 0,37	VFKB-45
HCBT/6-560/H	895	560	401	1,4	0,8	59	8.650	22	–	RMT-1,5	VFTM-Tri 0,37	VFKB-45
HCBT/6-630/H	910	630	596	2,3	1,3	62	10.950	25	–	RMT-1,5	VFTM-Tri 0,37	VFKB-45
HCBT/6-710/H	950	710	953	4,7	2,7	65	15.350	27	–	RMT-5	VFTM-Tri 1,5	VFKB-45
HCBT/6-800/L-X-0,55	940	800	1025	3,3	1,9	73	17.600	31	–	–	VFTM-Tri 0,75	VFKB-45
HCBT/6-800/H-X-0,75	935	800	1309	4,2	2,4	75	20.630	36	–	–	VFTM-Tri 1,1	VFKB-45
HCBT/6-900/L-X-1,1	960	900	1341	4,8	2,8	74	23.700	54	–	–	VFTM-Tri 1,5	VFKB-45
HCBT/6-900/H-X-1,5	955	900	2289	7,3	4,2	78	32.300	57	–	–	VFTM-Tri 1,5	VFKB-45
HCBT/6-1000/L-X-1,1	940	1000	1855	5,9	3,4	79	28.810	56	–	–	VFTM-Tri 1,5	VFKB-45
HCBT/6-1000/H-X-1,5	940	1000	2392	7,7	4,4	83	34.300	60	–	–	VFTM-Tri 2,2	VFKB-45

\* Sound pressure level measured in free field conditions at a distance equivalent to three times the diameter of the impeller with a minimum of 1,5 meters.

\*\* Three phase speed controllers (RMT) or inverter control (VFKB/VFTM): three phase 400V.

**REFERENCE**

<b>H</b>	<b>C</b>	<b>F</b>	<b>T</b>	<b>/</b>	<b>4</b>	<b>-</b>	<b>4</b>	<b>0</b>	<b>0</b>	<b>/</b>	<b>H</b>	<b>A</b>				<b>8</b>	<b>9</b>	
1	2	3	4		5		6				7							

- 1 - H:** Compact plate axial fan.
- 2 - C:** Series designation.
- 3 - Impeller type:**
  - F:** Ø 250-Ø 630 Fixed blade plastic impeller.
  - Ø 710 - Ø 1000 Aluminium impeller hub + adjustable plastic blade impellers.
  - G:** Adjustable plastic blade impellers.
  - B:** Ø 250-Ø 400 Fixed blade aluminium impeller Ø 450 - Ø 1000 Adjustable blade aluminium impeller.
- 4 - Electrical supply:**
  - B:** Single phase.
  - T:** Three phase.
- 5 - Number of poles:**
  - 2:** (approx. 2900 rpm - 50 Hz)
  - 4:** (approx. 1400 rpm - 50 Hz)
  - 6:** (approx. 900 rpm - 50 Hz)
- 6 - Nominal diameter of impeller (mm).**
- 7 - Pitch angle.**
  - H:** High.
  - I, L:** Low.
- 8 - Direction of air:**
  - A:** Motor over impeller.
- 9 - Special construction:**
  - X:** Motor support without inlet finger guard.
  - L:** Weatherproof protected.
- C:** Condensation drain holes on motor.
- EX:** Explosion proof versions in accordance to ATEX Directive, for three phase models:
  - EXE: Increased safety @ II2G EExIICT3
  - EXD: Flame proof, only for models 800 and 1000 @ II2G EExdIIBT5 or EExdIICT4
- G:** Special corrosion treatment for agricultural applications.
- TF:** With anticorrosive Teflon paint finish.

**SUPPLY VOLTAGES AND FREQUENCIES**



Mains supply voltage	Motor type	Connection	Speed
<b>SINGLE PHASE</b> 220V 50Hz, 240V 50Hz	230V 50Hz	See wiring diagram	High
<b>THREE PHASE</b> 220V 50Hz 240V 50Hz	230/400V 50Hz		High
			Low*
<b>THREE PHASE</b> 380V 50Hz 415V 50Hz	230/400V 50Hz		High
			High
	400V 50Hz		Low*

\* From sizes 450 up to 630 mm diameter.

**ACOUSTIC CHARACTERISTICS**

The sound levels shown in the technical characteristic chart and performance curves, correspond to the value of sound pressure dB(A), measured in free field conditions at a distance equivalent to three times the diameter of the impeller with a minimum of 1.5 meters.

Sound power level spectrum in dB(A) at the corresponding frequency band in Hz and the point of maximum flow.

Model	63	125	250	500	1000	2000	4000	8000	LwA
HCGB/2-315	50	61	68	70	72	69	64	58	77
HCGT/2-315	55	66	73	75	77	74	69	63	82
HCGB/2-355	55	66	73	75	77	74	69	63	82
HCGT/2-355	55	70	69	77	82	78	73	66	85

Model	63	125	250	500	1000	2000	4000	8000	LwA
/4-250/H	31	45	52	57	58	57	52	44	63
/4-315/H	42	53	60	62	64	61	56	50	69
/4-355/H	43	58	57	65	70	66	61	54	73
/4-400/H	48	61	62	68	73	69	66	57	76
/4-450/H	46	65	62	68	75	74	69	62	79
/4-500/H	49	68	68	74	78	76	72	65	82
/4-560/H	57	70	74	78	80	78	74	67	85
/4-630/H	57	72	76	81	85	82	79	72	89
/4-710/H	58	75	83	85	87	85	81	72	92
/4-800/L	58	77	87	93	93	89	83	76	97
/4-800/H	64	83	93	99	99	95	89	82	103
/4-900/L	59	81	91	97	98	94	88	80	102
/4-900/H	64	86	96	102	103	99	93	85	107
/4-1000/L	62	85	95	101	102	98	93	84	106
/4-1000/H	69	92	102	107	109	105	100	90	113

Model	63	125	250	500	1000	2000	4000	8000	LwA
/6-315/H	32	43	50	52	54	51	46	40	59
/6-355/H	32	47	46	54	59	55	50	43	62
/6-400/H	37	50	51	57	62	58	55	46	65
/6-450/H	35	54	51	57	64	63	58	51	68
/6-500/H	38	57	57	63	67	65	61	54	71
/6-560/H	46	59	63	67	69	67	63	56	74
/6-630/H	46	61	65	70	74	71	68	61	78
/6-710/H	49	66	74	76	78	76	72	63	83
/6-800/L	52	71	81	87	87	83	77	70	91
/6-800/H	54	73	83	89	89	85	79	72	93
/6-900/L	51	73	83	89	90	86	80	72	94
/6-900/H	55	77	87	93	94	90	84	76	98
/6-1000/L	56	78	89	94	96	92	86	77	100
/6-1000/H	60	83	93	99	100	96	91	82	104

**DIMENSIONS (mm)**

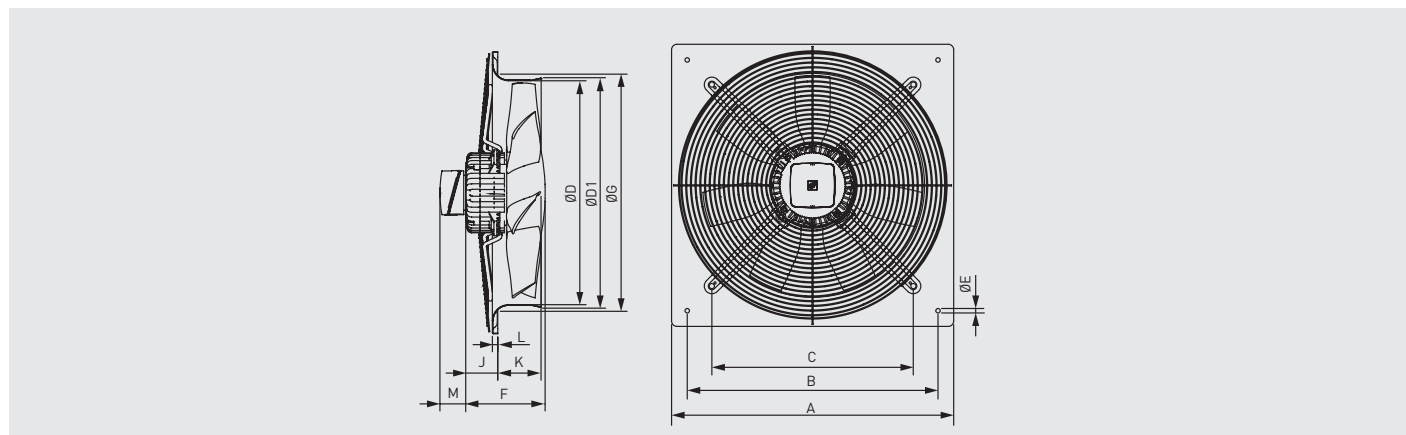

Model	A	B	C	Ø D	Ø D1	Ø E	F			Ø G	J			K	L	M	
							Number of poles				Number of poles					Three phase	Single phase
							/2	/4	/6		/2	/4	/6				
250	315	260	220	254	261	10		122	294		59	53	12	60	65		
315	400	330	280	315	320	10	129	122	122	329	45	32	32	68	12	60	65
355	450	380	315	355	363	10	129	129	129	371	45	45	45	75	12	60	65
400	500	420	355	400	410	10		129	129	422		40,5	40,5	78	12	60	65
450	560	480	400	450	457	10		150	150	476		48	48	91	12	60	65
500	630	560	450	500	512	10		150	150	536		44,5	44,5	97	12	60	65
560	710	630	510	560	570	10		218,5	150	596		110,5	42	98,5	12	60	65
630	800	710	580	630	640	12		218,5	150	674		110,5	41	103	12	60	65
710	900	800	636	710	720	12		220	218,5	733		114	134	91,5	16,5	60	65

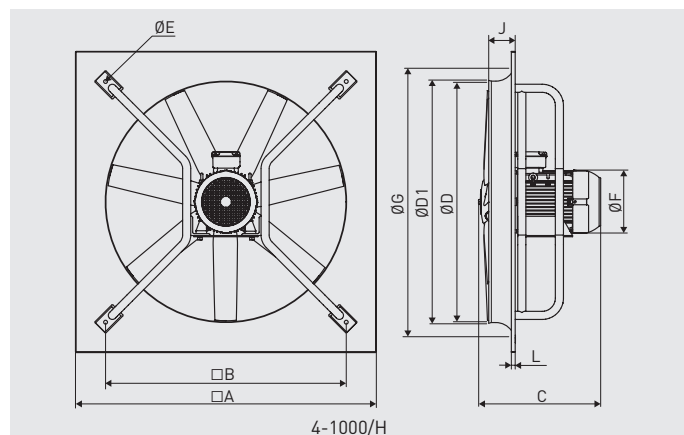
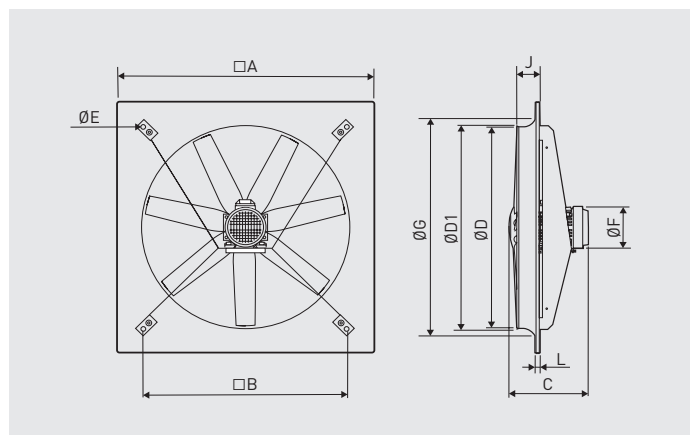

Modelo	A	B	Ø D	Ø D1	Ø E	J	Ø G	C				Ø F			
								/4		/6		/4		/6	
								L	H	L	H	L	H	L	H
800	1000	800	800	810	18	92	926	363	442	318	363	180	200	160	180
900	1120	900	900	910	18	120	1060	442	512	400	400	200	280	200	200
1000	1250	1000	1000	1010	18	110	1154	442	-	345	400	200	-	200	200
4-1000/H	1250	1000	1000	1010	16	110	1154	-	512	-	-	-	280	-	-

**MOUNTING ACCESSORIES**

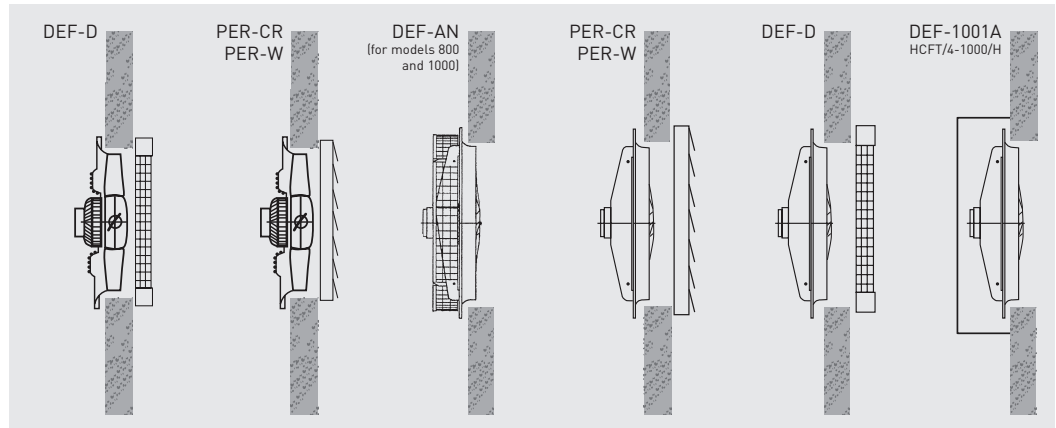
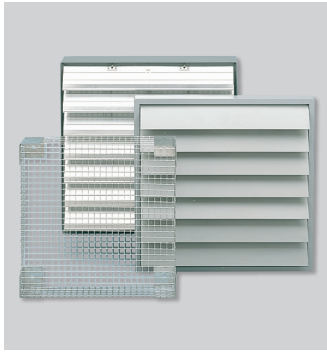

Model HCFB/HCFT HCBB/HCBT	Wire Protection Guards		Exhaust Side Louvre Shutters		
	Outlet	Inlet	Plastic	Aluminium	ATEX version*
250	DEF-250 D	-	PER-250 W	PER-250 CR	PER-315 Ex
315	DEF-325 D	-	PER-355 W	PER-355 CR	PER-315 Ex
355	DEF-375 D	-	PER-355 W	PER-355 CR	PER-355 Ex
400	DEF-450 D	-	PER-400 W	PER-400 CR	PER-400 Ex
450	DEF-450 D	-	PER-450 W	PER-450 CR	PER-450 Ex
500	DEF-525 D	-	PER-500 W	PER-500 CR	PER-500 Ex
560	DEF-630 D	-	PER-560 W	PER-630 CR	PER-560 Ex
630	DEF-630 D	-	PER-630 W	PER-630 CR	PER-630 Ex
710	DEF-800 D	-	PER-710 W	PER-710 CR	PER-710 Ex
800	DEF-800 D	DEF-800 AN	PER-800 W	PER-800 CR	-
/4-900/H	DEF-1000 D	DEF-900 AN	PER-1000 W	PER-1000 CR	-
/4-900/L	DEF-1000 D	DEF-901 AN	PER-1000 W	PER-1000 CR	-
/6-900	DEF-1000 D	DEF-901 AN	PER-1000 W	PER-1000 CR	-
1000	DEF-1000 D	DEF-1000 AN	PER-1000 W	PER-1000 CR	-
/4-1000 / H	DEF-1000 D	DEF-1001 AN	PER-1000 W	PER-1000 CR	-

\* Three phase speed controllers (RMT) or inverter control (VFKB/VFTM): three phase 400V.

**ELECTRICAL ACCESSORIES**



**REB-1N / REB-2,5N**  
 Single phase electronic speed controllers.



**REB-5  
 REB-10**  
 Single phase electronic speed controllers.



**RMT**  
 Three phase auto transformer speed controllers.



**COM D/S**  
 To connect three phase fans with 400 V motor. For three phase models.



**VFTM TRI IP54**  
 Adjustable frequency drive for three phase motors from 0,37 to 15 kW. 230 V or 400 V.



**VFKB IP65**  
 Adjustable frequency drives for three phase motors from 0,37 to 4 kW 230 V or 400 V.

**PERFORMANCE CURVES - 2 POLE MOTORS**

- $q_v$ : Airflow in  $m^3/h$  and  $m^3/s$ .
- $p_{sf}$ : Static pressure in Pa.
- $p_g$ : Protection guard pressure drop in Pa.
- SFP: Specific fan power in  $W/m^3/s$ .
- P: Input power in W.
- Measurement category: A.
- Efficiency category: static.
- Fan efficiency without speed control.
- Fan tested without protection guard.
- Airflow data in accordance with ISO 5801.
- Sound pressure level dB(A), measured in a free field distance equal to 3 times the diameter, with a minimum of 1,5 m.

- MC** Measurement category
- EC** Efficiency category
- VSD** Speed control: supplied with the fan
- SR** Specific ratio
- $\eta$ [%]** Efficiency
- N** Efficiency grade
- [kW]** Absorbed power
- [ $m^3/h$ ]** Airflow
- [Pa]** Static pressure
- [RPM]** Speed

HCGB/2-315/L

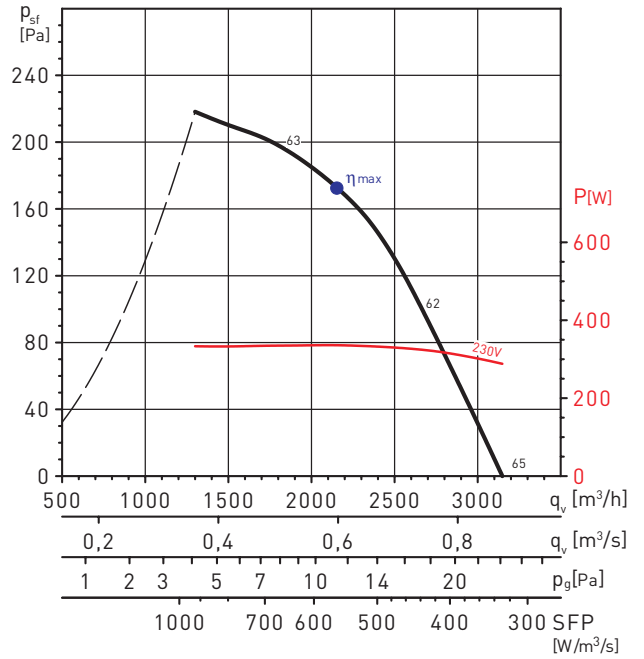

MC	EC	VSD	SR	$\eta$ [%]	N	[kW]	[ $m^3/h$ ]	[Pa]	[RPM]
A	Static	No	1	30,8	40,1	0,336	2106	177	2597

HCGB/2-355/J

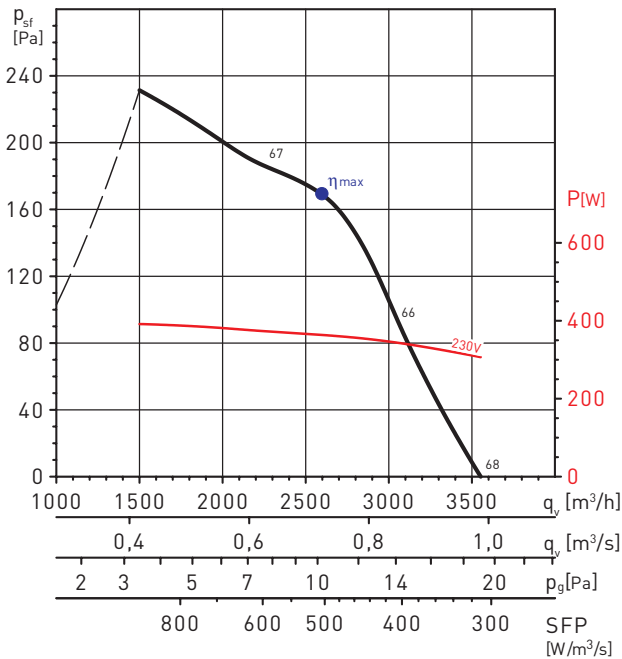

MC	EC	VSD	SR	$\eta$ [%]	N	[kW]	[ $m^3/h$ ]	[Pa]	[RPM]
A	Static	No	1	33,8	42,9	0,364	2597	169	2590

HCGT/2-315/L

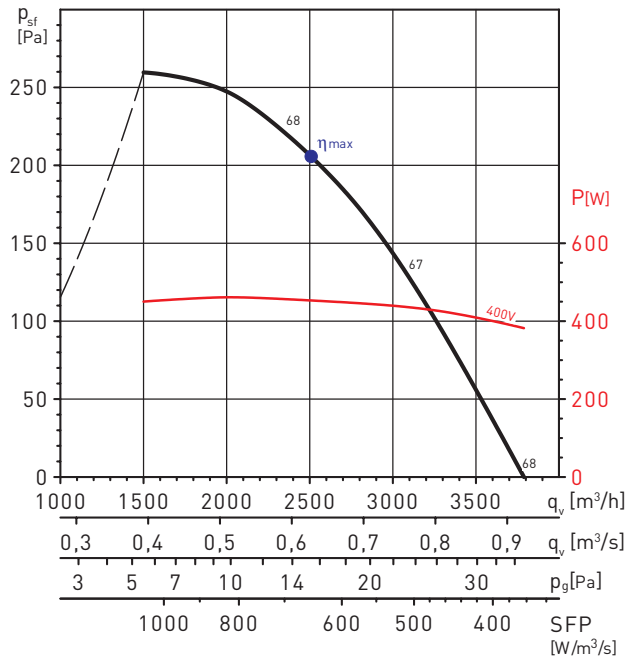

MC	EC	VSD	SR	$\eta$ [%]	N	[kW]	[ $m^3/h$ ]	[Pa]	[RPM]
A	Static	No	1	31,7	40,2	0,455	2440	212	2543



PERFORMANCE CURVES - 2 and 4 POLE MOTORS

HCGT/2-355/I

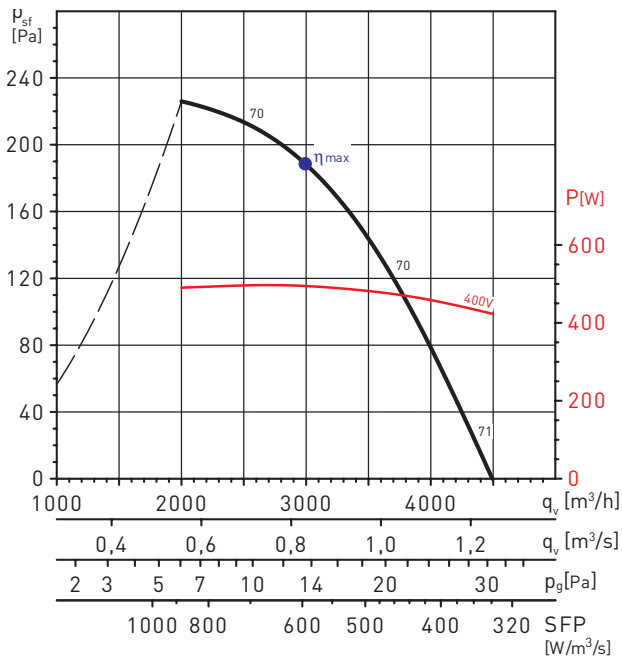

HCFB/4-250/H

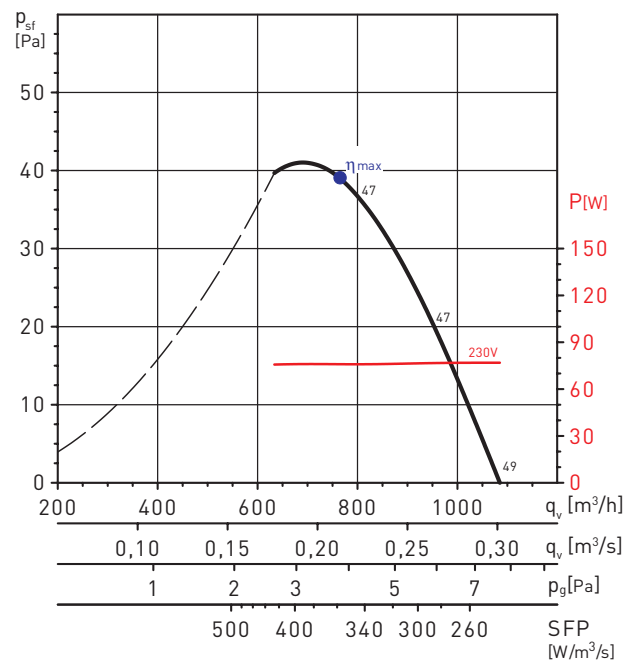

MC	EC	VSD	SR	$\eta$ [%]	N	[kW]	[m <sup>3</sup> /h]	[Pa]	[RPM]
A	Static	No	1	31,7	40,0	0,495	2997	188	2454

HCFB/4-315/H

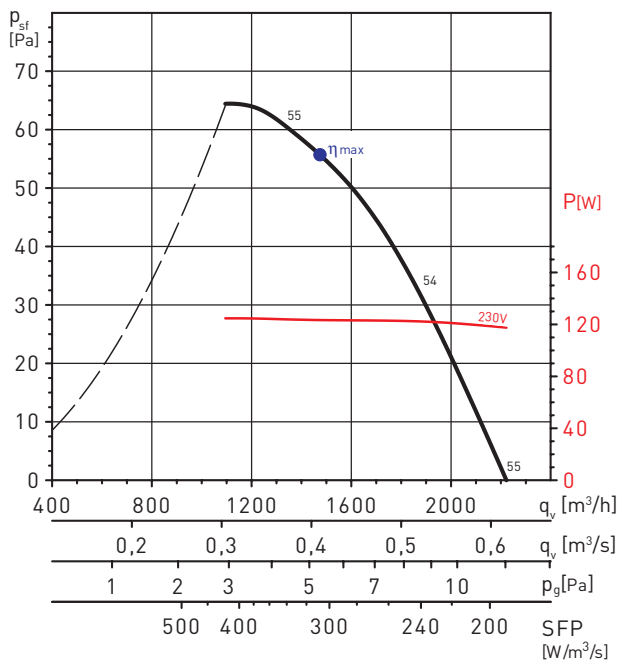

HCFB/4-355/H

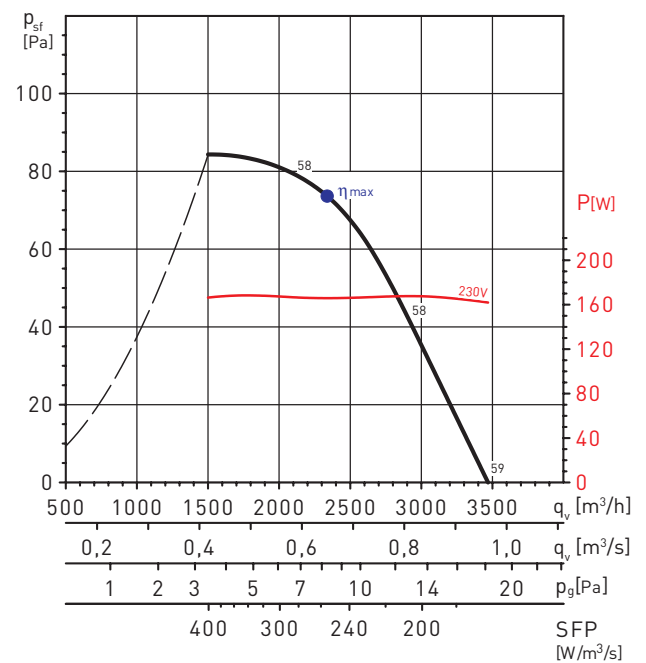

MC	EC	VSD	SR	$\eta$ [%]	N	[kW]	[m <sup>3</sup> /h]	[Pa]	[RPM]
A	Static	No	1	28,8	40,1	0,166	2339	74	1406

**PERFORMANCE CURVES - 4 POLE MOTORS**

HCFB/4-400/H

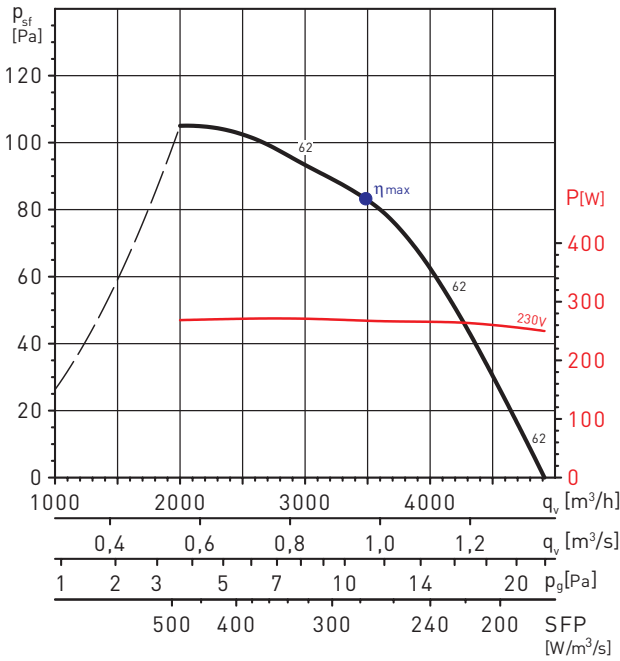

MC	EC	VSD	SR	$\eta$ [%]	N	[kW]	[m³/h]	[Pa]	[RPM]
A	Static	No	1	30,1	40,0	0,268	3488	83	1411

HCFB/4-450/H

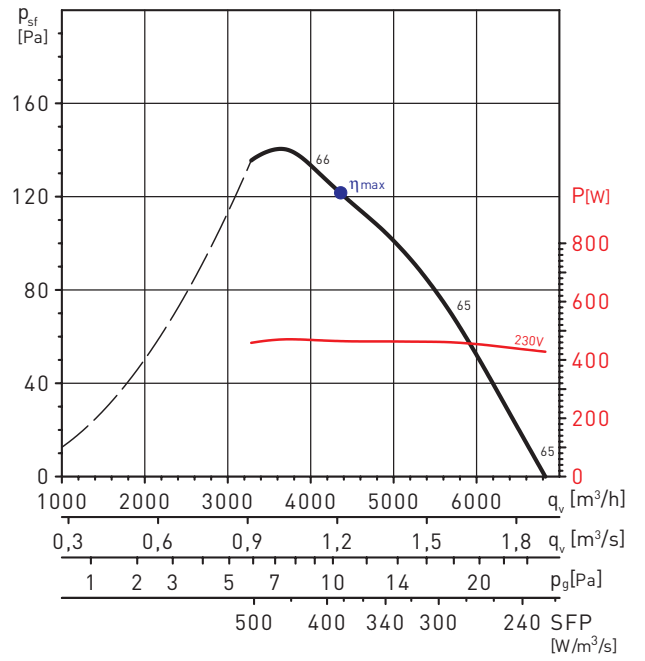

MC	EC	VSD	SR	$\eta$ [%]	N	[kW]	[m³/h]	[Pa]	[RPM]
A	Static	No	1	31,7	40,1	0,466	4214	126	1351

HCFB/4-500/H

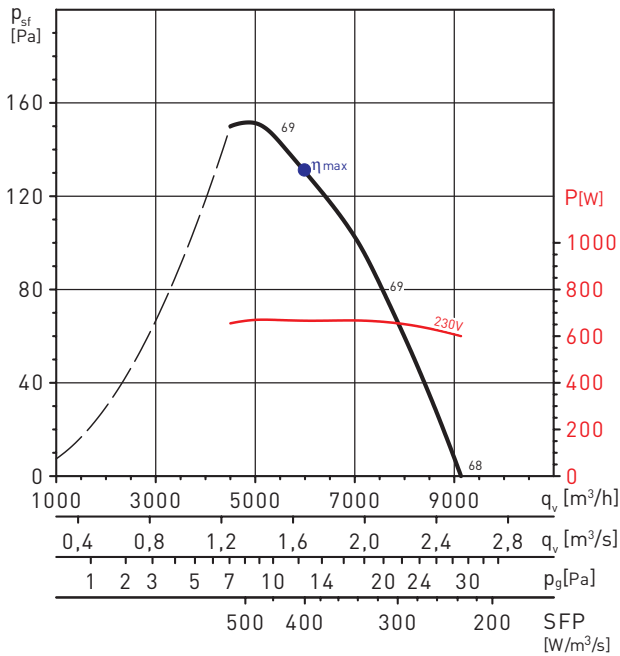

MC	EC	VSD	SR	$\eta$ [%]	N	[kW]	[m³/h]	[Pa]	[RPM]
A	Static	No	1	32,8	40,2	0,667	5735	137	1351

HCFB/4-560/H

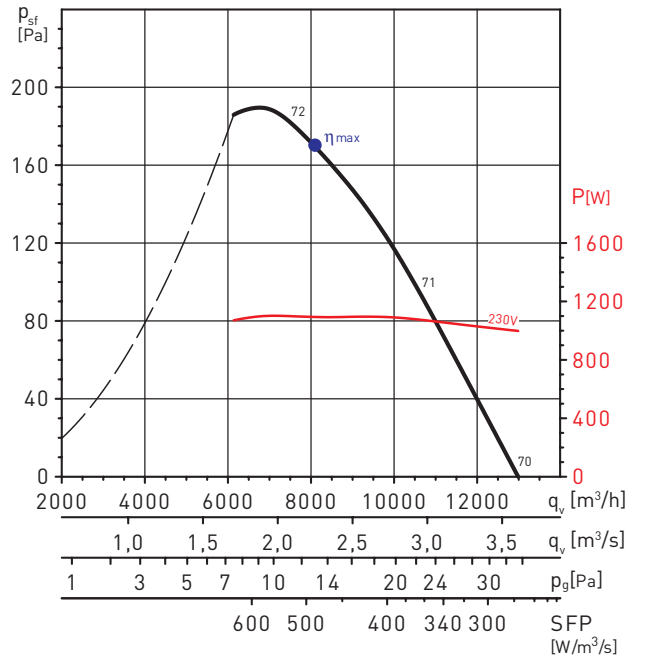

MC	EC	VSD	SR	$\eta$ [%]	N	[kW]	[m³/h]	[Pa]	[RPM]
A	Static	No	1	34,9	41,0	1,093	8081	170	1386

**PERFORMANCE CURVES - 4 POLE MOTORS**

HCFB/4-630/H

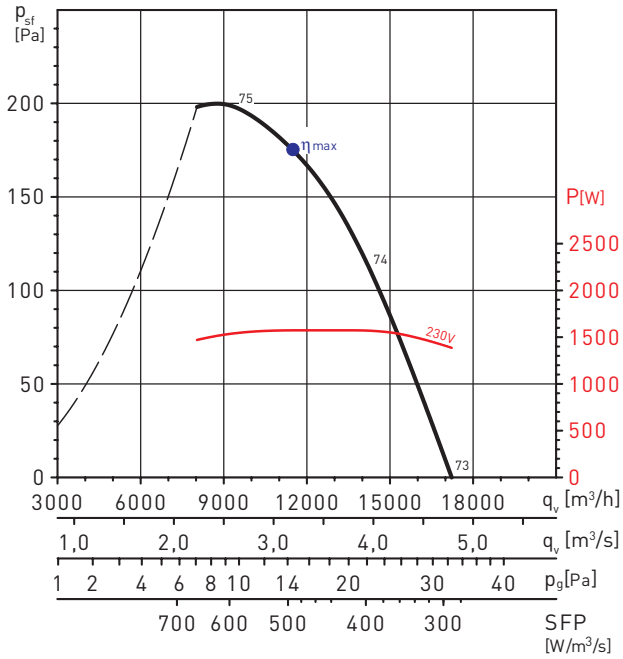

HCFT/4-250/H

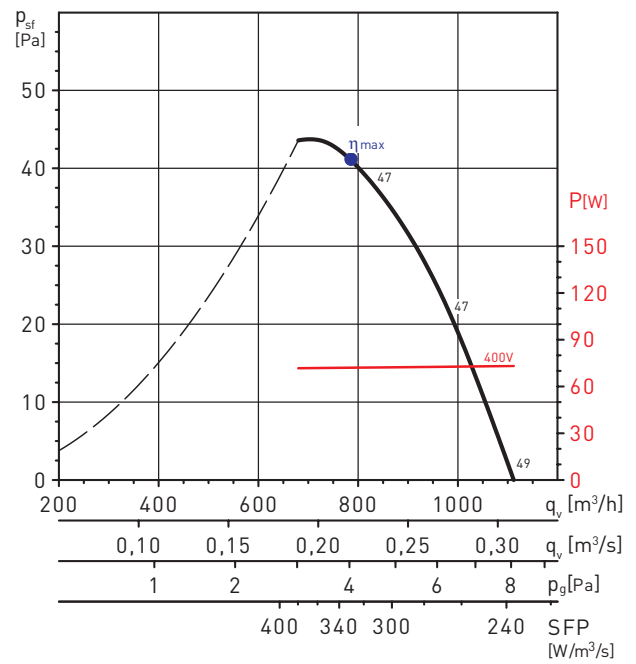

MC	EC	VSD	SR	η[%]	N	[kW]	[m³/h]	[Pa]	[RPM]
A	Static	No	1	35,5	40,6	1,573	11483	175	1345

HCFT/4-315/H

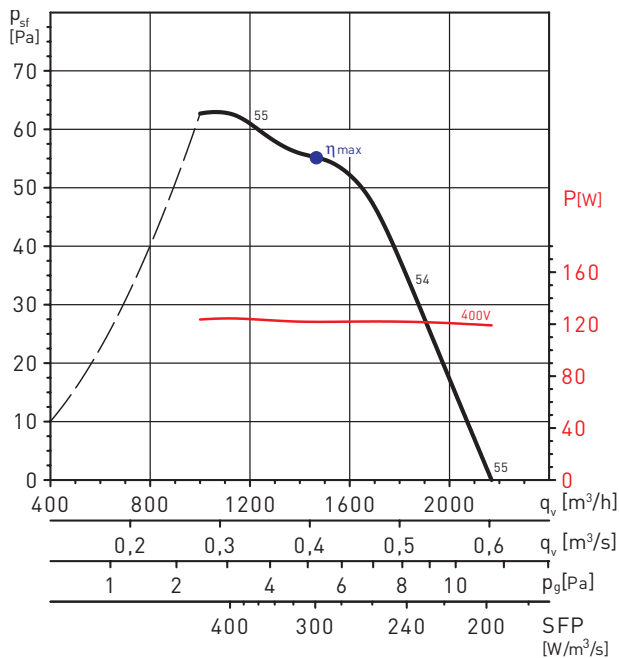

HCFT/4-355/H

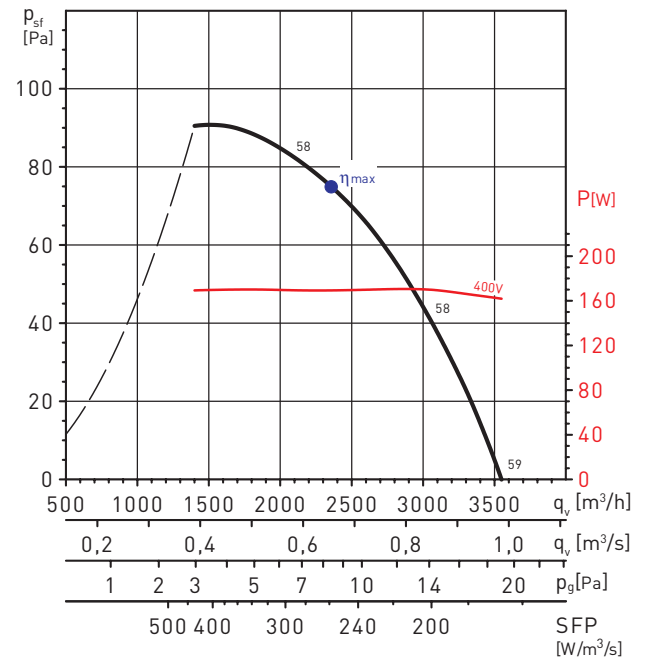

MC	EC	VSD	SR	η[%]	N	[kW]	[m³/h]	[Pa]	[RPM]
A	Static	No	1	29,0	40,2	0,169	2331	76	1379

**PERFORMANCE CURVES - 4 POLE MOTORS**

HCFT/4-400/H

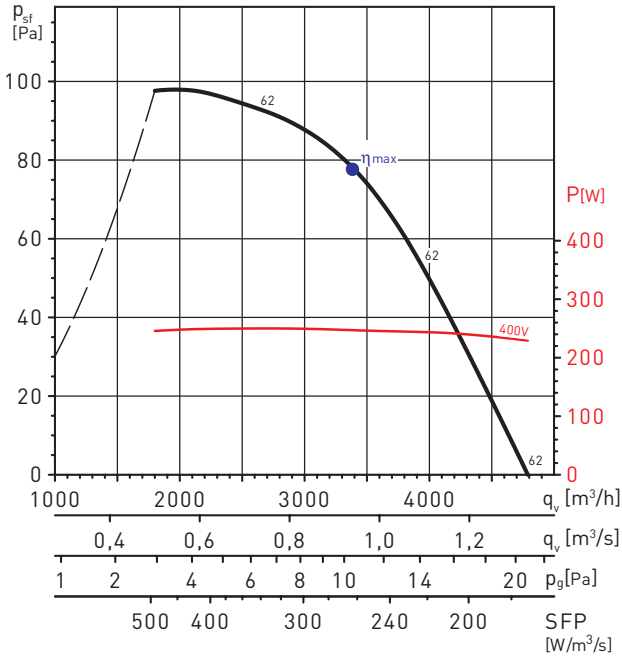

MC	EC	VSD	SR	$\eta$ [%]	N	[kW]	[m³/h]	[Pa]	[RPM]
A	Static	No	1	29,8	40,0	0,248	3257	82	1354

HCFT/4-450/H

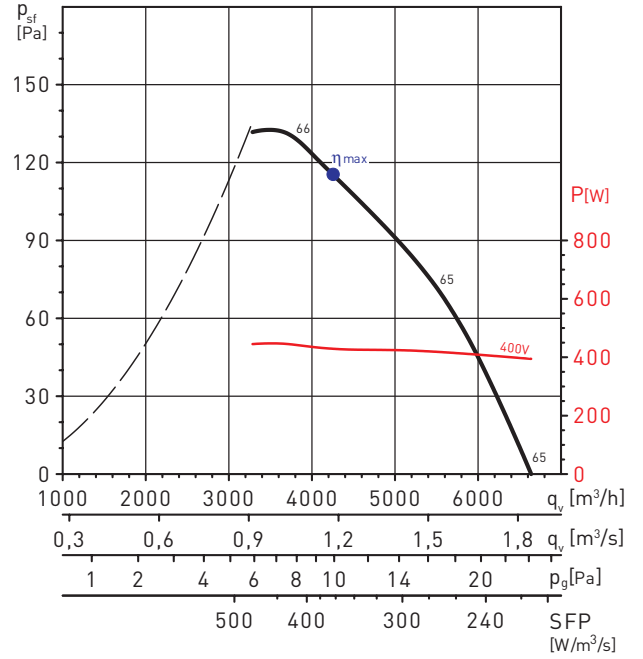

MC	EC	VSD	SR	$\eta$ [%]	N	[kW]	[m³/h]	[Pa]	[RPM]
A	Static	No	1	31,8	40,5	0,429	4261	115	1351

HCFT/4-500/H

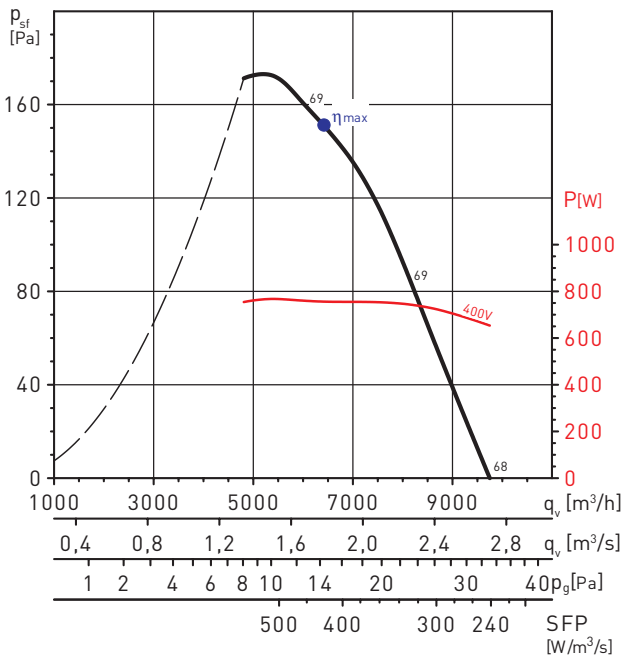

MC	EC	VSD	SR	$\eta$ [%]	N	[kW]	[m³/h]	[Pa]	[RPM]
A	Static	No	1	35,7	42,8	0,756	6476	150	1449

HCFT/4-560/H

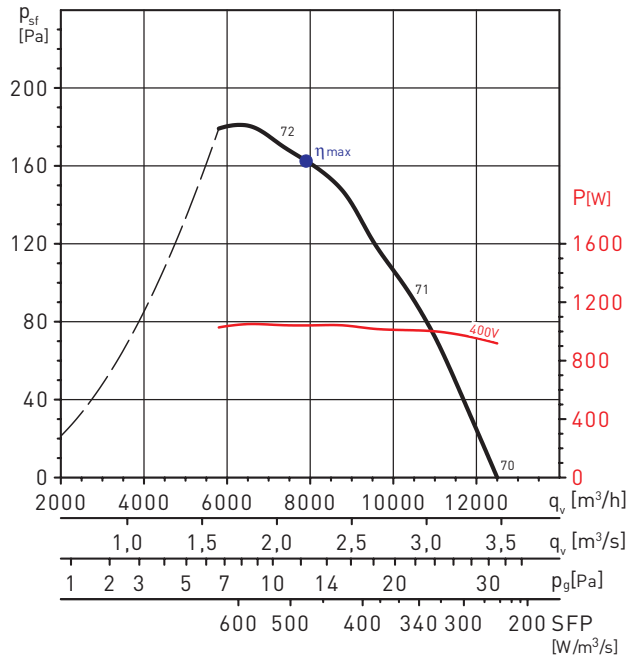

MC	EC	VSD	SR	$\eta$ [%]	N	[kW]	[m³/h]	[Pa]	[RPM]
A	Static	No	1	34,9	41,1	1,045	8422	156	1377

**PERFORMANCE CURVES - 4 POLE MOTORS**

HCFT/4-630/H

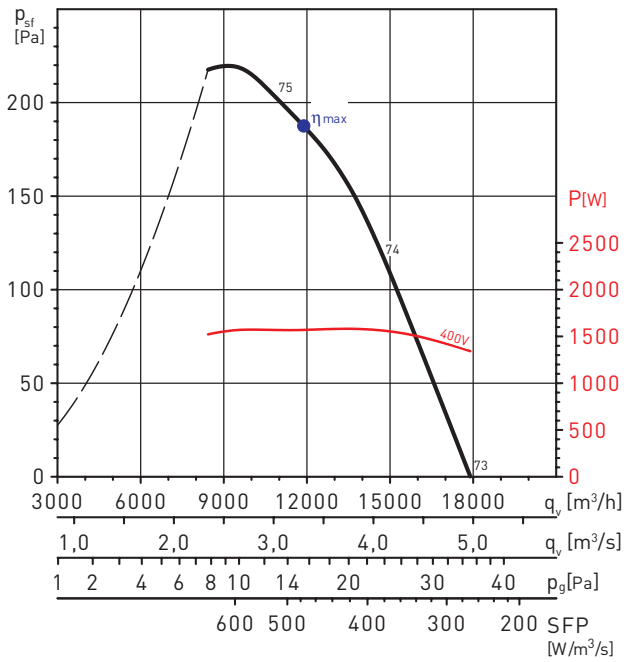

MC	EC	VSD	SR	$\eta$ [%]	N	[kW]	[m³/h]	[Pa]	[RPM]
A	Static	No	1	39,5	44,6	1,569	11760	189	1404

HCFT/4-710/H

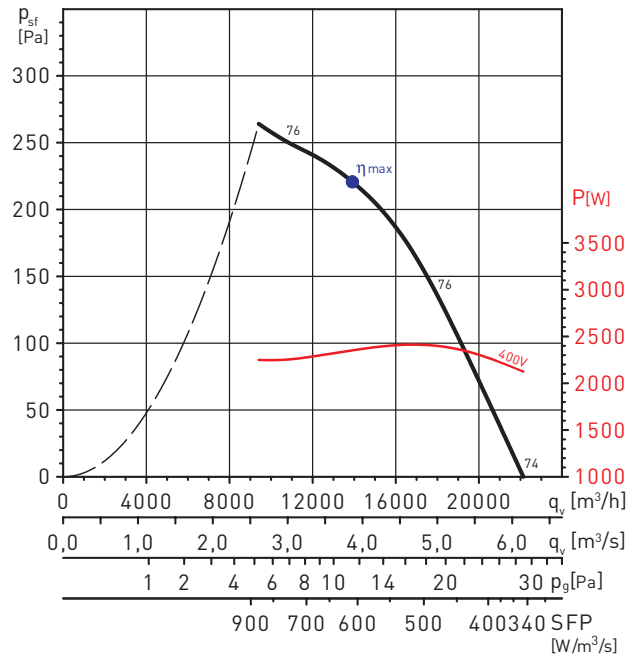

MC	EC	VSD	SR	$\eta$ [%]	N	[kW]	[m³/h]	[Pa]	[RPM]
A	Static	No	1	36,3	40,3	2,352	13929	221	1354

HCFT/4-800/L

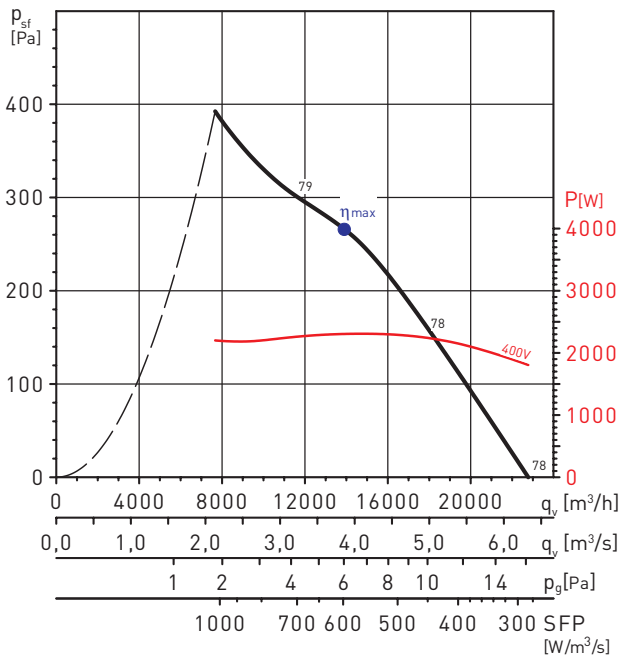

MC	EC	VSD	SR	$\eta$ [%]	N	[kW]	[m³/h]	[Pa]	[RPM]
A	Static	No	1	44,7	48,7	2,305	13900	266	1392

HCFT/4-800/H

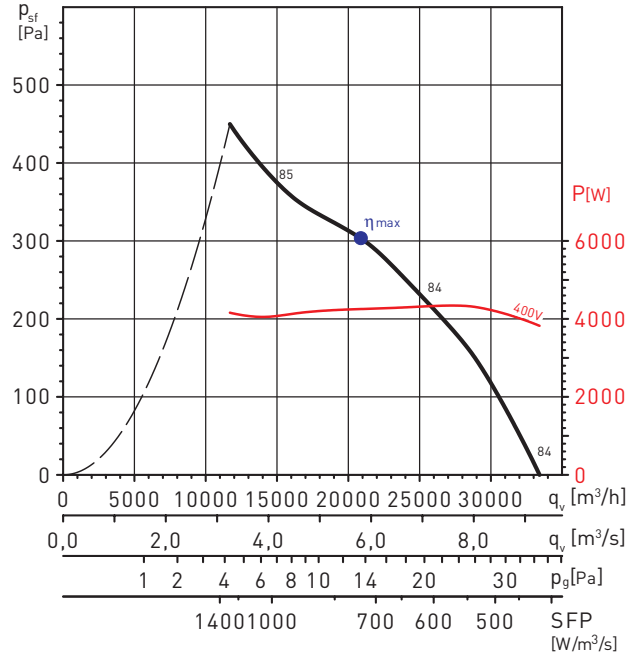

MC	EC	VSD	SR	$\eta$ [%]	N	[kW]	[m³/h]	[Pa]	[RPM]
A	Static	No	1	41,4	43,8	4,253	20873	304	1435

**PERFORMANCE CURVES - 4 POLE MOTORS**

HCFT/4-900/L

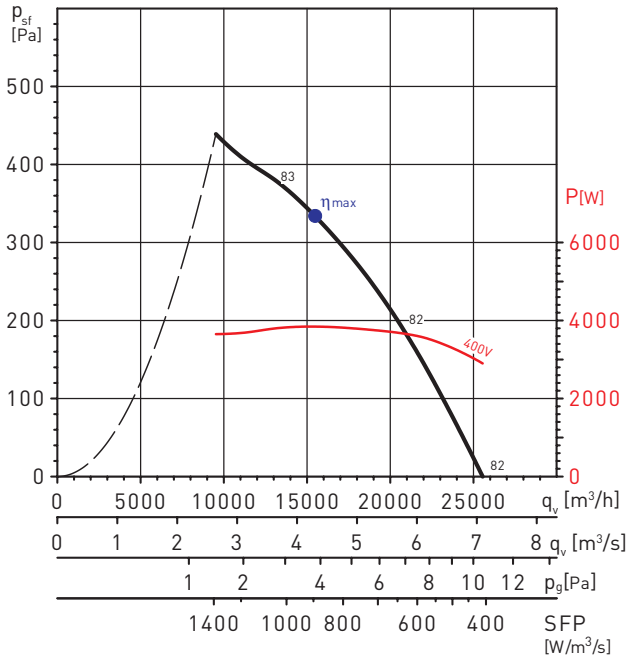

MC	EC	VSD	SR	$\eta$ [%]	N	[kW]	[m <sup>3</sup> /h]	[Pa]	[RPM]
A	Static	No	1	37,4	40,0	3,844	15455	334	1442

HCFT/4-900/H

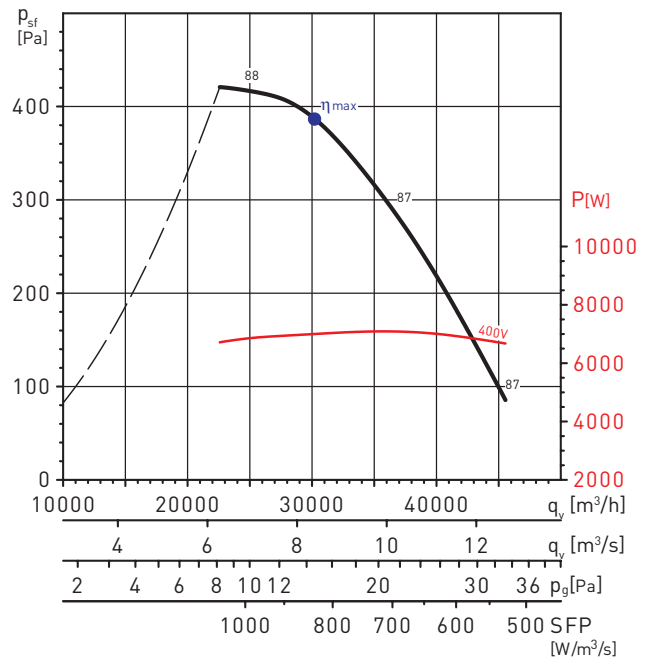

MC	EC	VSD	SR	$\eta$ [%]	N	[kW]	[m <sup>3</sup> /h]	[Pa]	[RPM]
A	Static	No	1	46,3	47,3	7,001	30198	387	1455

HCFT/4-1000/L

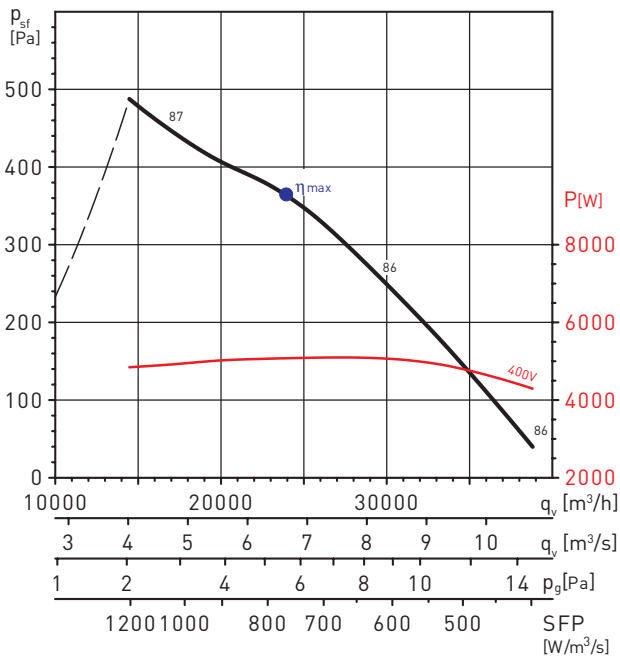

MC	EC	VSD	SR	$\eta$ [%]	N	[kW]	[m <sup>3</sup> /h]	[Pa]	[RPM]
A	Static	No	1	47,6	49,5	5,076	23915	364	1421

HCFT/4-1000/H

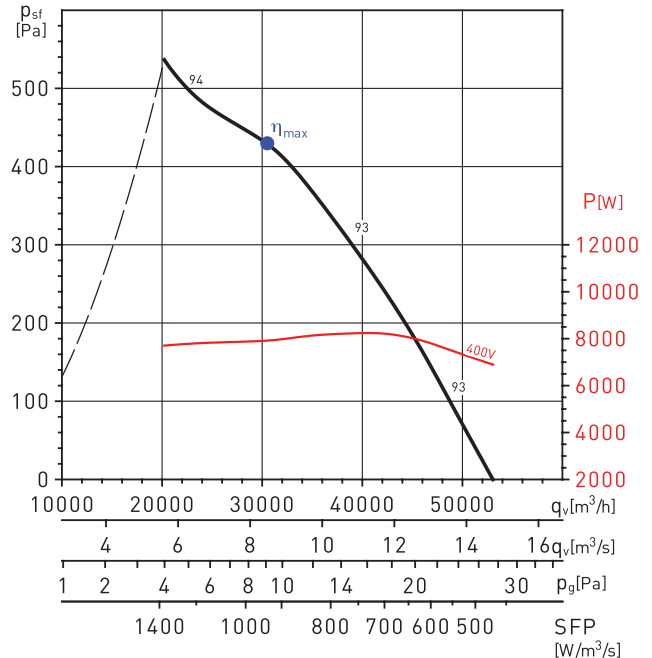

MC	EC	VSD	SR	$\eta$ [%]	N	[kW]	[m <sup>3</sup> /h]	[Pa]	[RPM]
A	Static	No	1	46,1	46,8	7,912	30528	430	1469

**PERFORMANCE CURVES - 6 POLE MOTORS**

HCFB/6-315/H

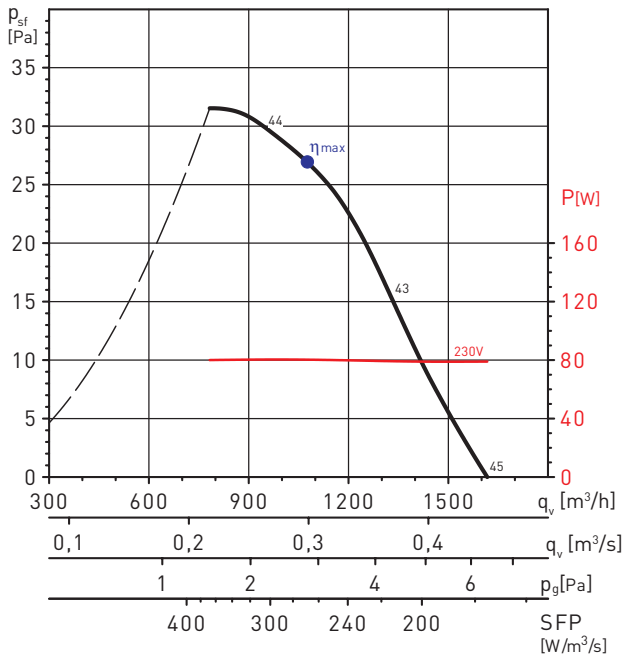

HCFB/6-355/H

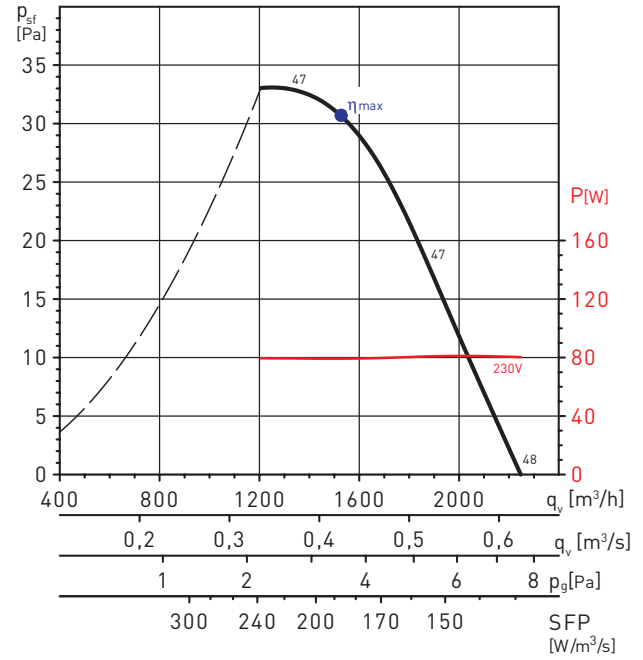

HCFB/6-400/H

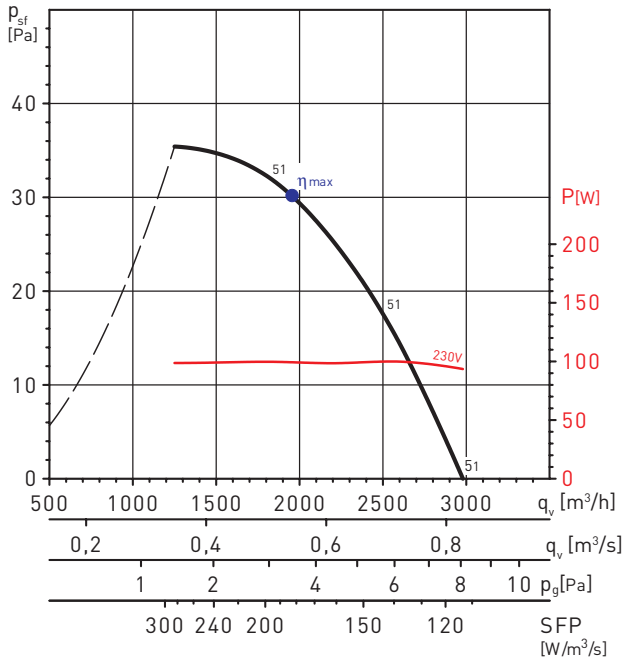

HCFB/6-450/H

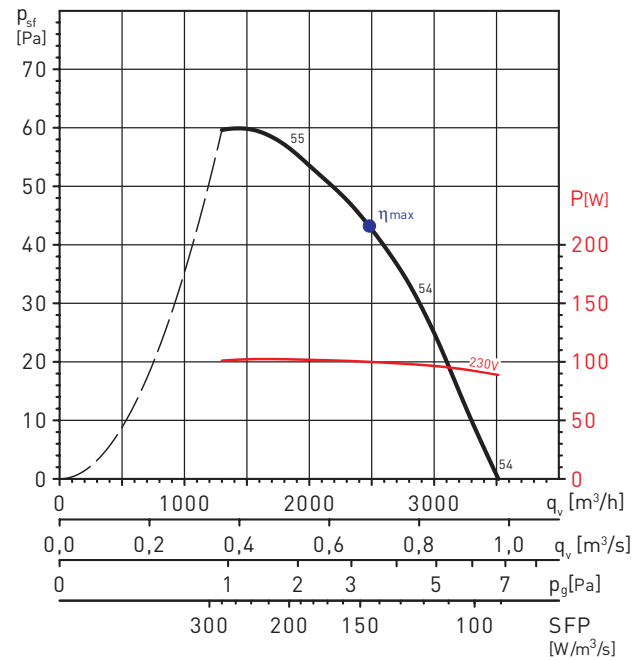

MC	EC	VSD	SR	$\eta$ [%]	N	[kW]	[m³/h]	[Pa]	[RPM]
A	Static	No	1	30,2	42,8	0,101	2327	47	885

**PERFORMANCE CURVES - 6 POLE MOTORS**

HCFB/6-500/H

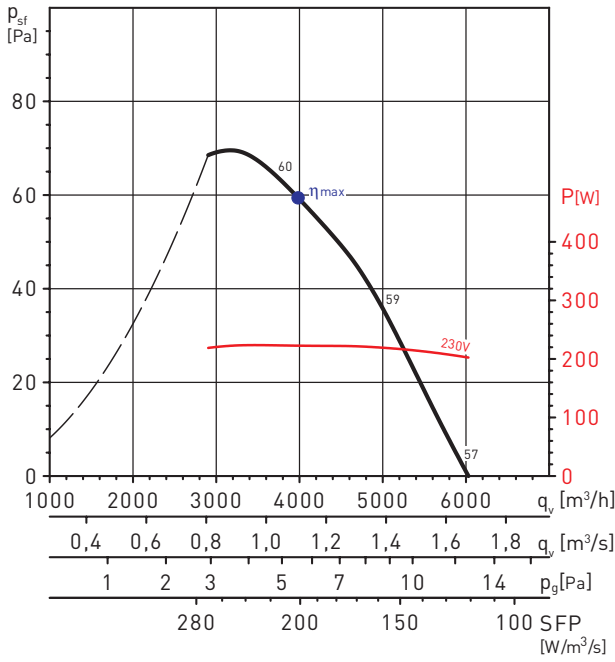

MC	EC	VSD	SR	$\eta$ [%]	N	[kW]	[m³/h]	[Pa]	[RPM]
A	Static	No	1	29,7	40,1	0,223	3783	63	904

HCFB/6-560/H

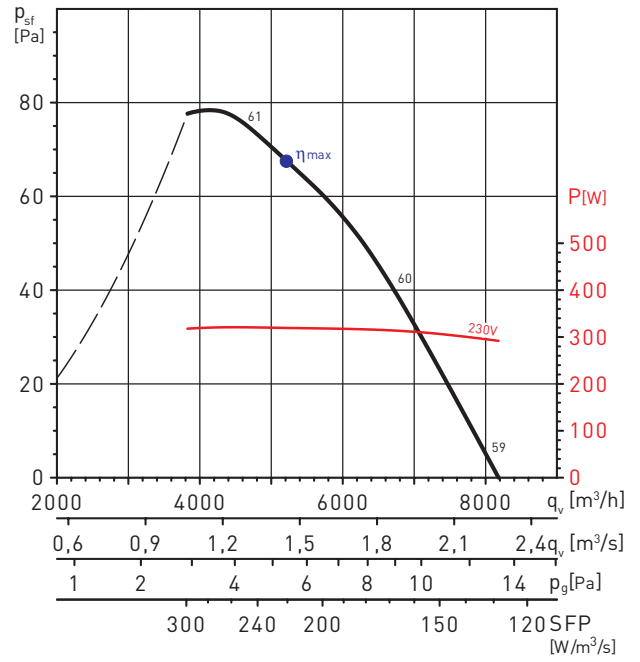

MC	EC	VSD	SR	$\eta$ [%]	N	[kW]	[m³/h]	[Pa]	[RPM]
A	Static	No	1	30,7	40,2	0,319	5214	68	880

HCFB/6-630/H

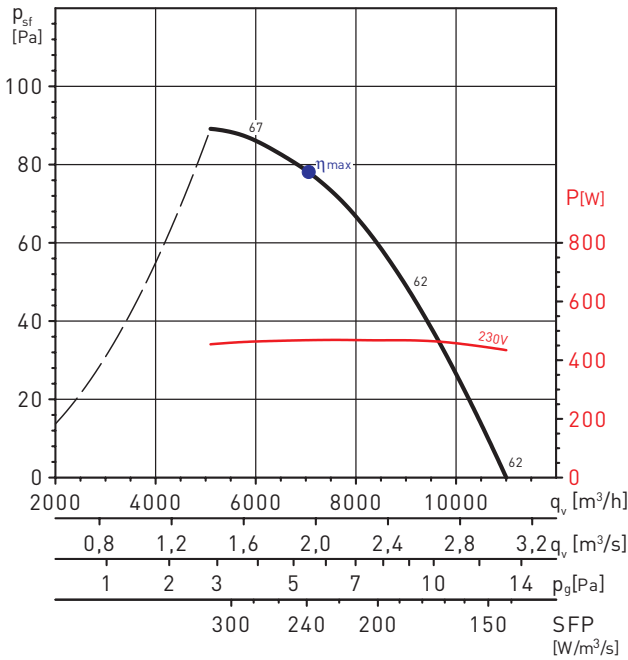

MC	EC	VSD	SR	$\eta$ [%]	N	[kW]	[m³/h]	[Pa]	[RPM]
A	Static	No	1	32,7	41,1	0,469	7230	76	899

HCFT/6-355/H

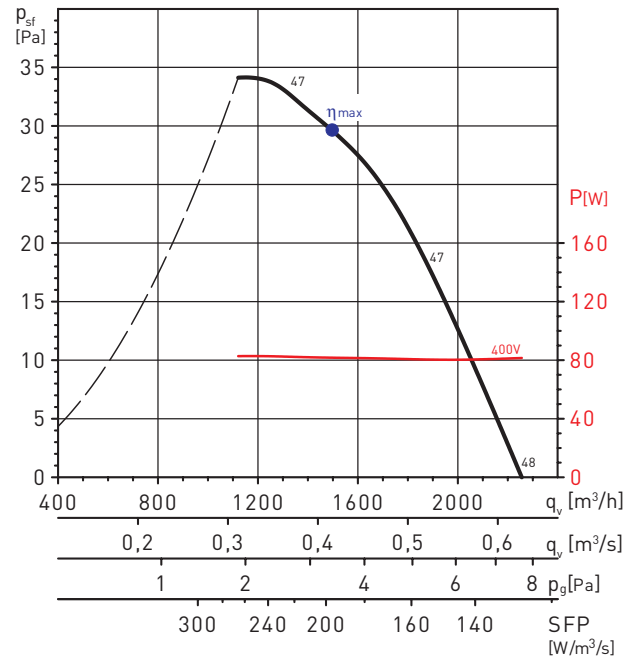

MC	EC	VSD	SR	$\eta$ [%]	N	[kW]	[m³/h]	[Pa]	[RPM]
A	Static	No	1	32,7	41,1	0,469	7230	76	899



**PERFORMANCE CURVES - 6 POLE MOTORS**

HCFT/6-400/H

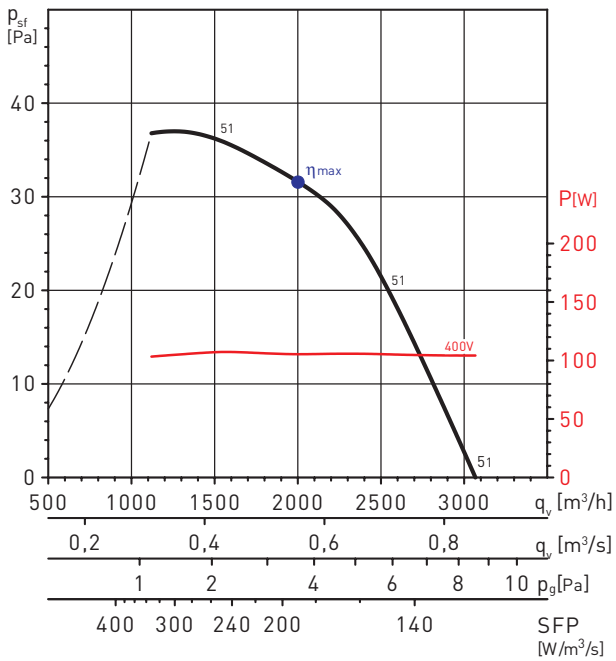

HCFT/6-450/H

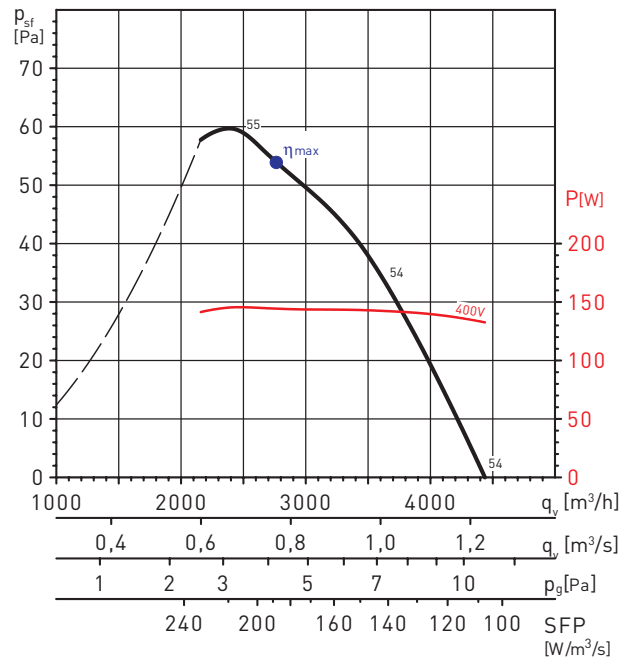

MC	EC	VSD	SR	η[%]	N	[kW]	[m³/h]	[Pa]	[RPM]
A	Static	No	1	28,8	40,4	0,144	2920	51	897

HCFT/6-500/H

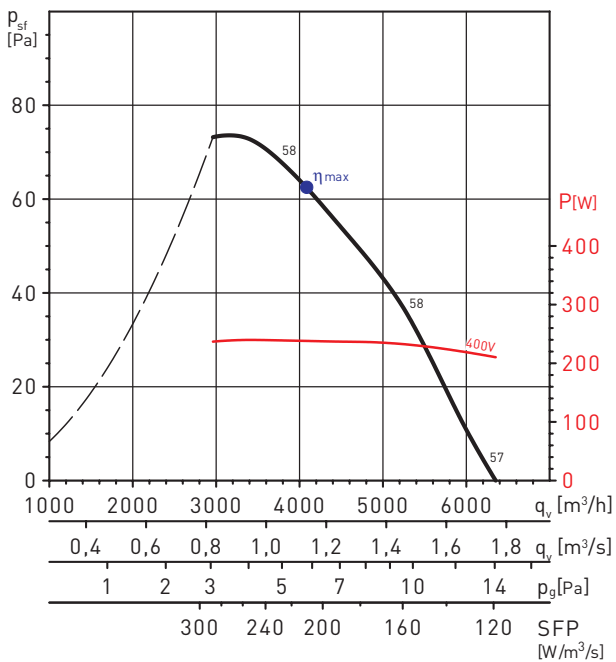

HCFT/6-560/H

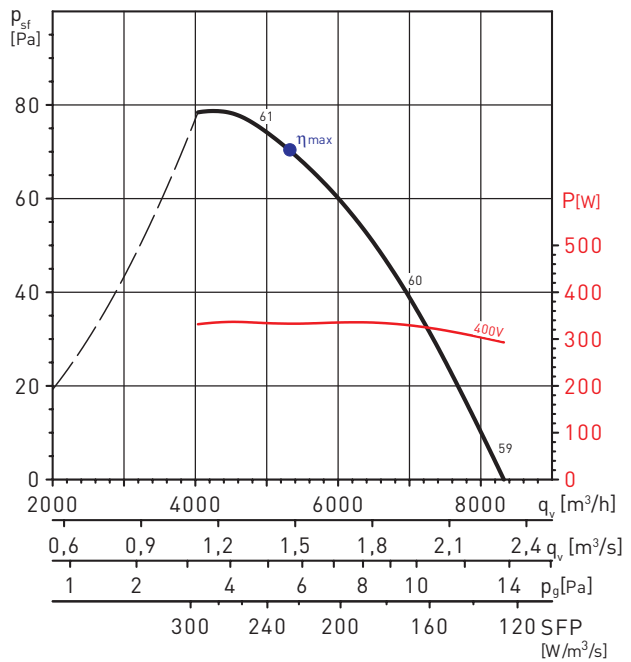

MC	EC	VSD	SR	η[%]	N	[kW]	[m³/h]	[Pa]	[RPM]
A	Static	No	1	29,9	40,2	0,239	3900	66	903

MC	EC	VSD	SR	η[%]	N	[kW]	[m³/h]	[Pa]	[RPM]
A	Static	No	1	31,2	40,5	0,333	5333	70	905

**PERFORMANCE CURVES - 6 POLE MOTORS**

HCFT/6-630/H

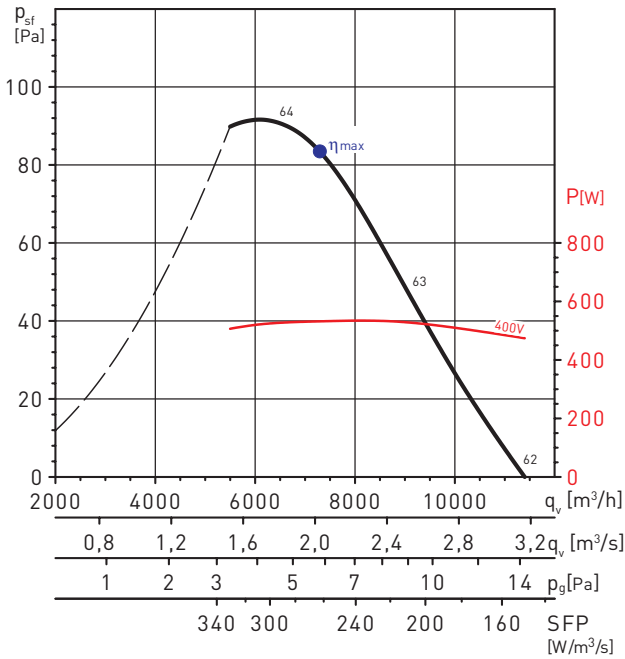

MC	EC	VSD	SR	$\eta$ [%]	N	[kW]	[m³/h]	[Pa]	[RPM]
A	Static	No	1	31,9	40,0	0,531	7080	86	904

HCFT/6-710/H

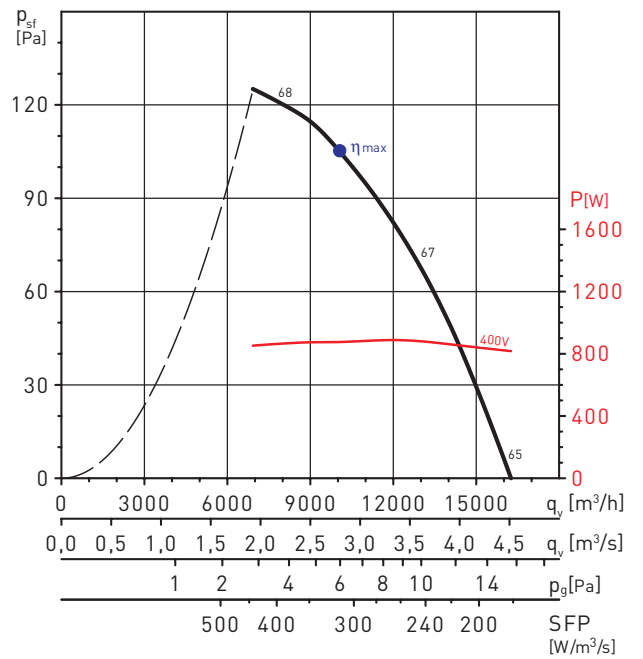

MC	EC	VSD	SR	$\eta$ [%]	N	[kW]	[m³/h]	[Pa]	[RPM]
A	Static	No	1	33,5	40,2	0,876	10055	105	949

HCFT/6-800/L

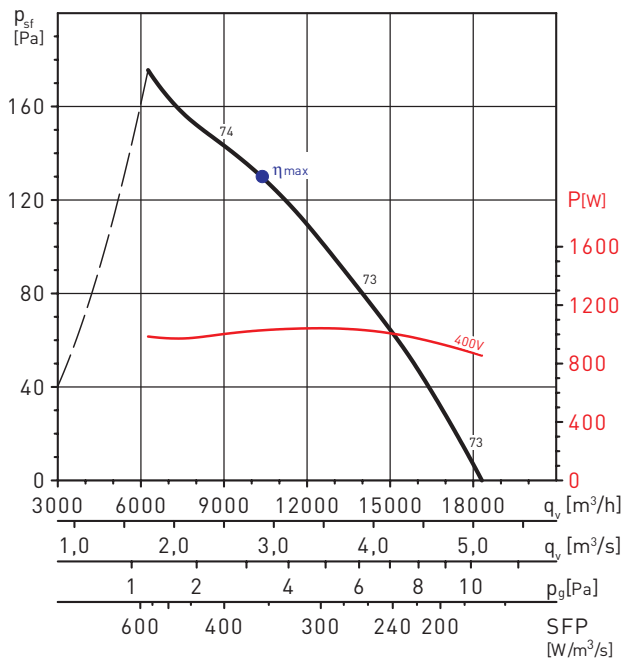

MC	EC	VSD	SR	$\eta$ [%]	N	[kW]	[m³/h]	[Pa]	[RPM]
A	Static	No	1	36,4	42,7	1,028	10372	130	922

HCFT/6-800/H

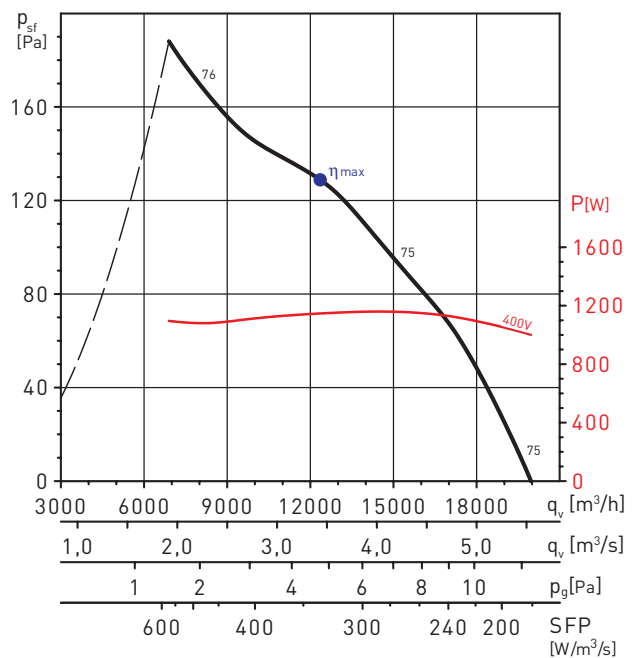

MC	EC	VSD	SR	$\eta$ [%]	N	[kW]	[m³/h]	[Pa]	[RPM]
A	Static	No	1	38,7	44,7	1,147	12360	129	931

**PERFORMANCE CURVES - 6 POLE MOTORS**

HCFT/6-900/L

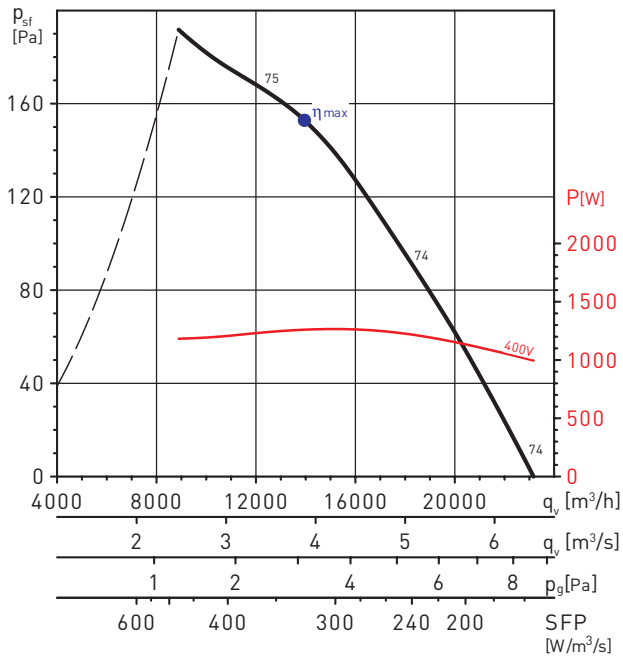

MC	EC	VSD	SR	$\eta$ [%]	N	[kW]	[m³/h]	[Pa]	[RPM]
A	Static	No	1	47,1	52,8	1,260	13960	153	954

HCFT/6-900/H

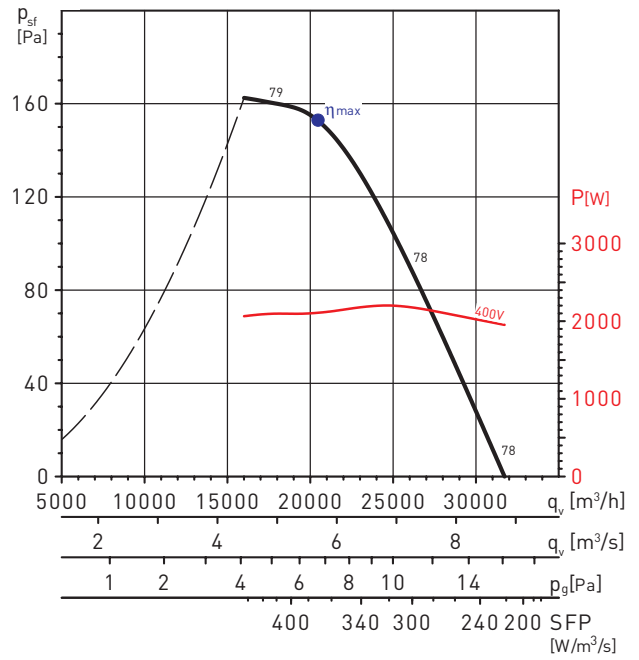

MC	EC	VSD	SR	$\eta$ [%]	N	[kW]	[m³/h]	[Pa]	[RPM]
A	Static	No	1	41,2	45,5	2,107	20461	153	947

HCFT/6-1000/L

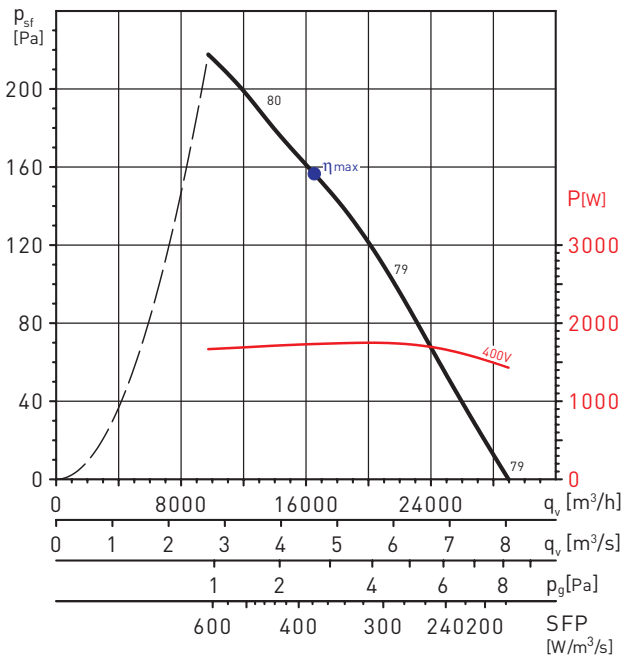

MC	EC	VSD	SR	$\eta$ [%]	N	[kW]	[m³/h]	[Pa]	[RPM]
A	Static	No	1	41,6	46,4	1,733	16522	157	926

HCFT/6-1000/H

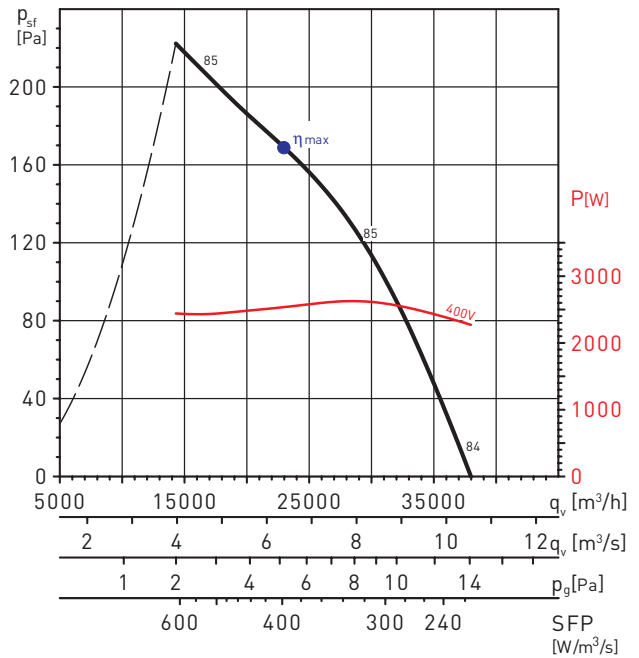

MC	EC	VSD	SR	$\eta$ [%]	N	[kW]	[m³/h]	[Pa]	[RPM]
A	Static	No	1	42,6	46,4	2,536	22959	169	931

**PERFORMANCE CURVES - 4 POLE MOTORS**

HCBB/4-250/H

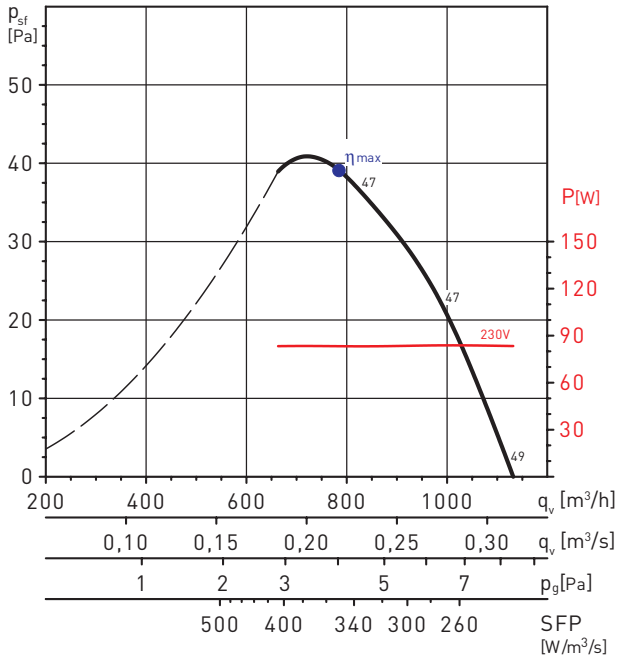

HCBB/4-315/H

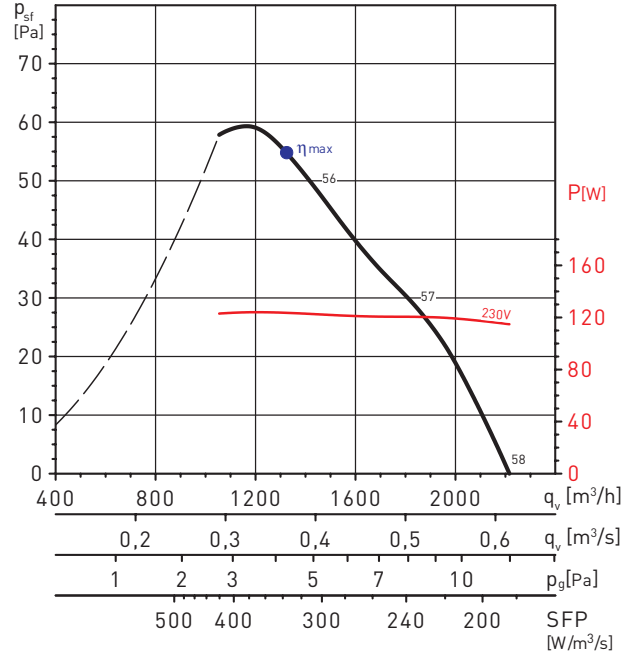

HCBB/4-355/H

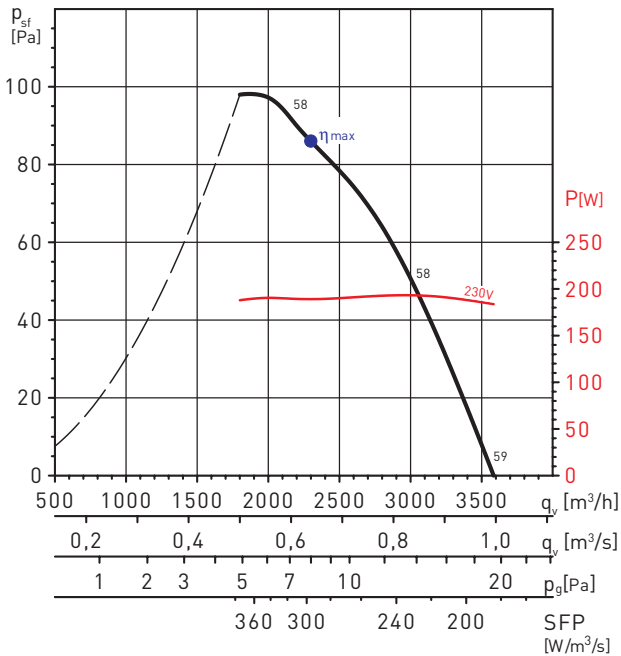

HCBB/4-400/H

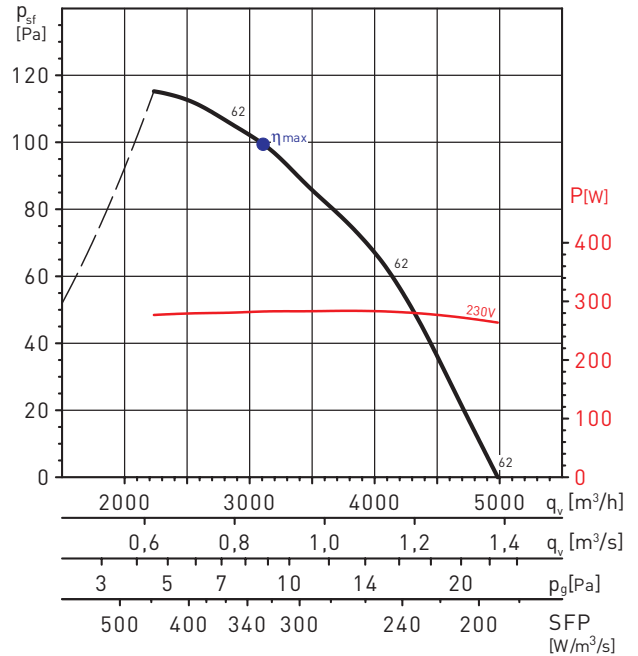

MC	EC	VSD	SR	η[%]	N	[kW]	[m³/h]	[Pa]	[RPM]
A	Static	No	1	29,1	40,0	0,189	2300	86	1377

MC	EC	VSD	SR	η[%]	N	[kW]	[m³/h]	[Pa]	[RPM]
A	Static	No	1	30,4	40,2	0,283	3107	100	1327

**PERFORMANCE CURVES - 4 POLE MOTORS**

HCBB/4-450/H

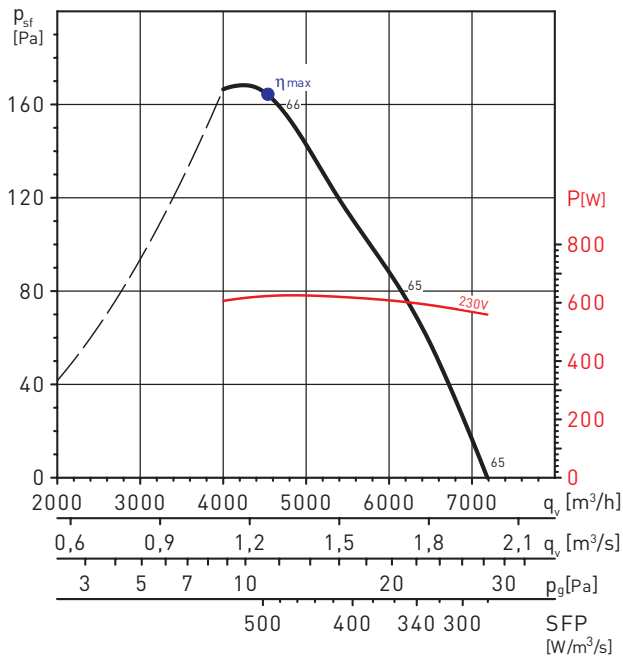

MC	EC	VSD	SR	$\eta$ [%]	N	[kW]	[m <sup>3</sup> /h]	[Pa]	[RPM]
A	Static	No	1	33,2	40,8	0,623	4538	164	1390

HCBB/4-500/H

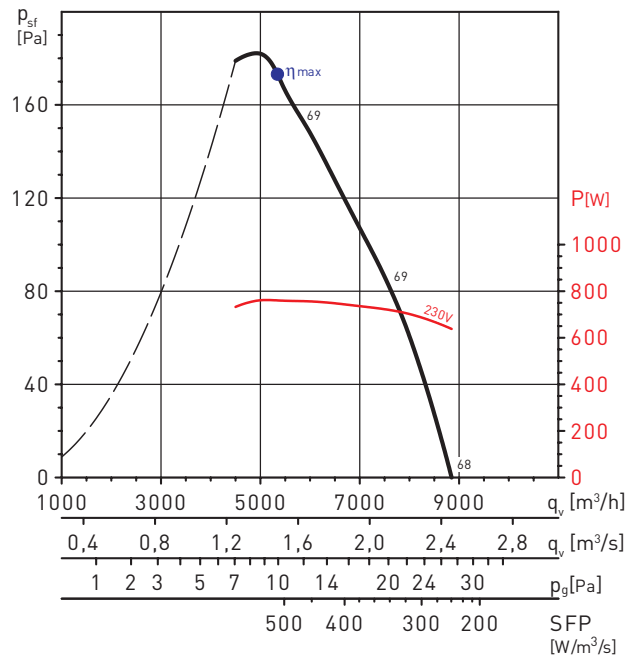

MC	EC	VSD	SR	$\eta$ [%]	N	[kW]	[m <sup>3</sup> /h]	[Pa]	[RPM]
A	Static	No	1	33,6	40,7	0,760	5336	172	1322

HCBB/4-560/H

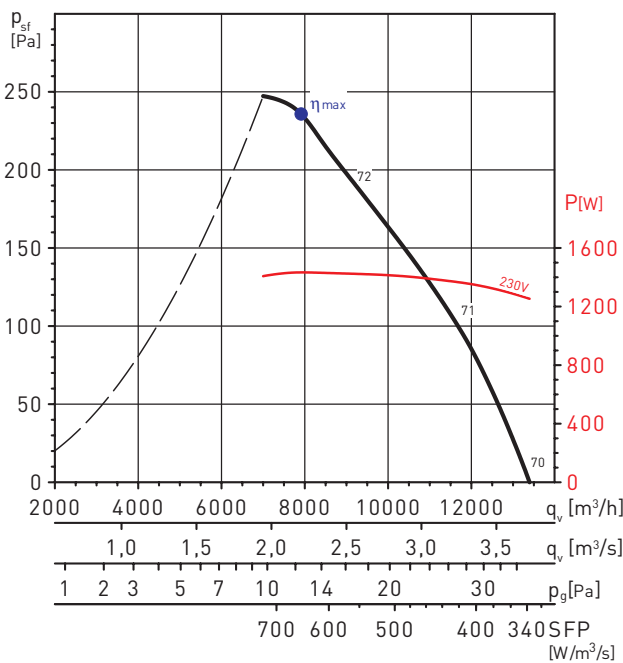

MC	EC	VSD	SR	$\eta$ [%]	N	[kW]	[m <sup>3</sup> /h]	[Pa]	[RPM]
A	Static	No	1	36,0	41,3	1,433	7896	235	1367

HCBB/4-630/H

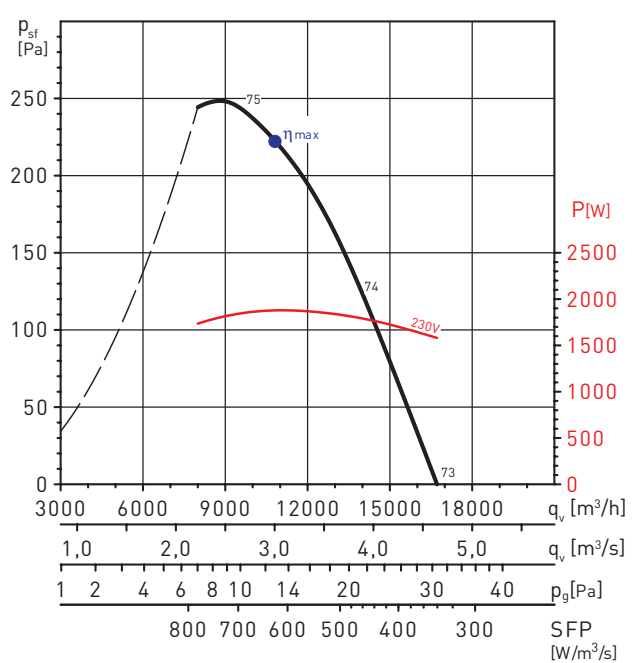

MC	EC	VSD	SR	$\eta$ [%]	N	[kW]	[m <sup>3</sup> /h]	[Pa]	[RPM]
A	Static	No	1	35,6	40,2	1,878	10817	223	1305

**PERFORMANCE CURVES - 4 POLE MOTORS**

HCBT/4-250/H

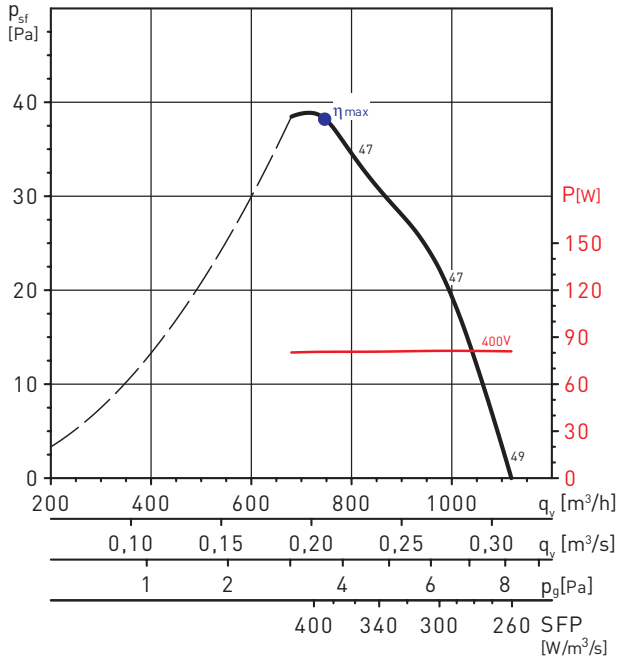

HCBT/4-315/H

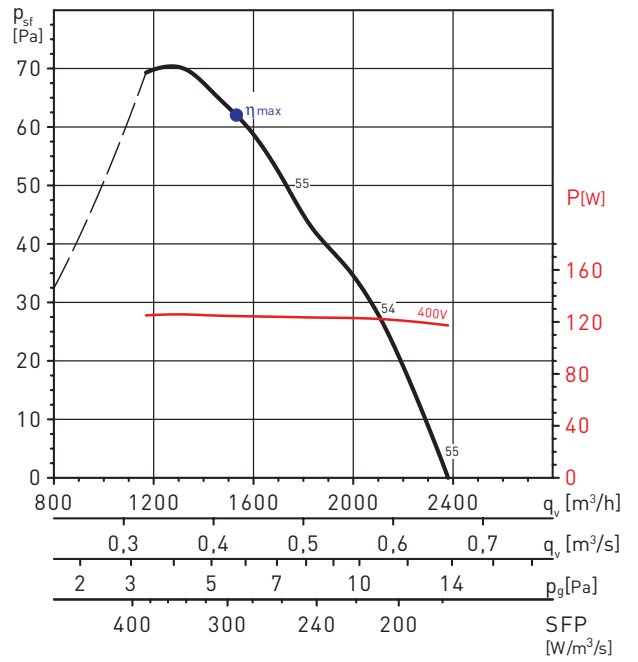

HCBT/4-355/H

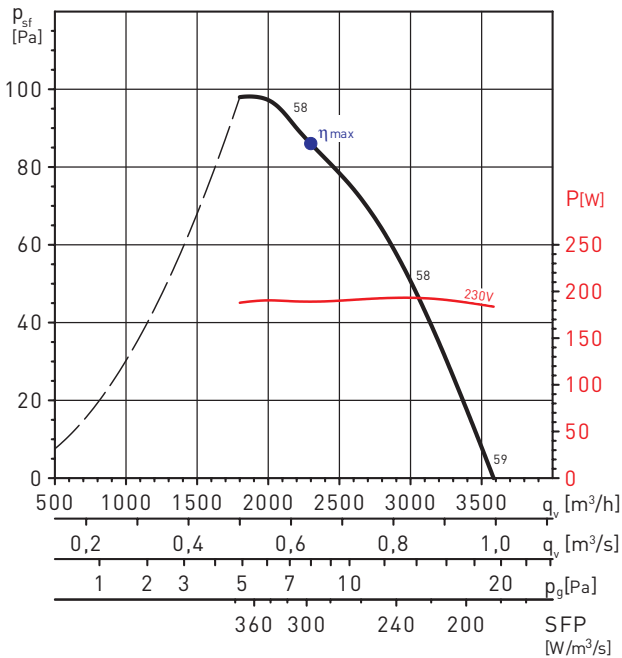

HCBT/4-400/H

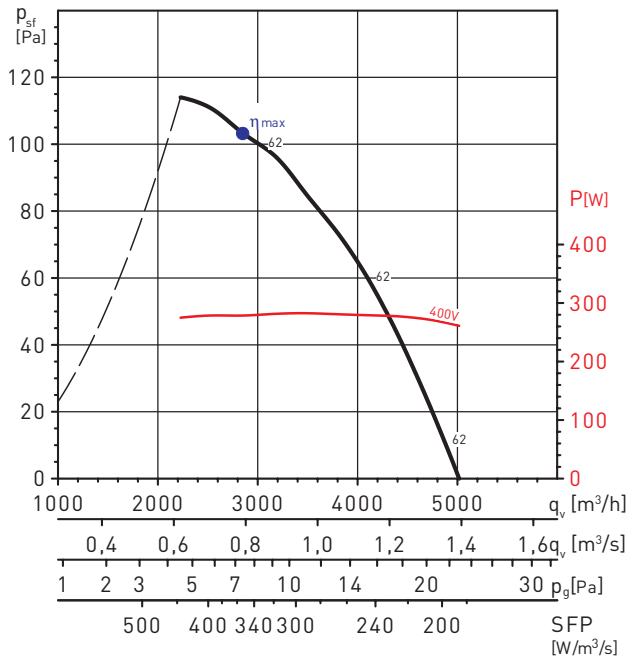

MC	EC	VSD	SR	η[%]	N	[kW]	[m³/h]	[Pa]	[RPM]
A	Static	No	1	29,0	40,0	0,179	2163	86	1372

MC	EC	VSD	SR	η[%]	N	[kW]	[m³/h]	[Pa]	[RPM]
A	Static	No	1	30,2	40,0	0,281	3127	98	1332

**PERFORMANCE CURVES - 4 POLE MOTORS**

HCBT/4-450/H

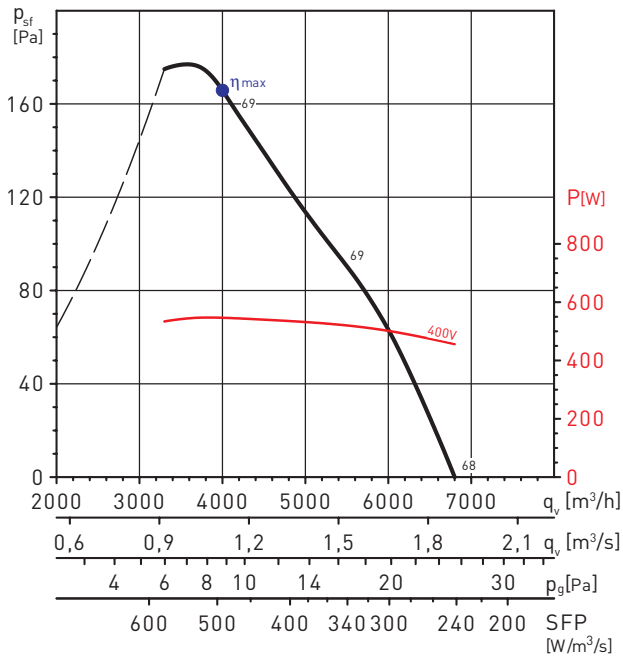

MC	EC	VSD	SR	$\eta$ [%]	N	[kW]	[m³/h]	[Pa]	[RPM]
A	Static	No	1	33,6	41,3	0,605	4179	175	1391

HCBT/4-500/H

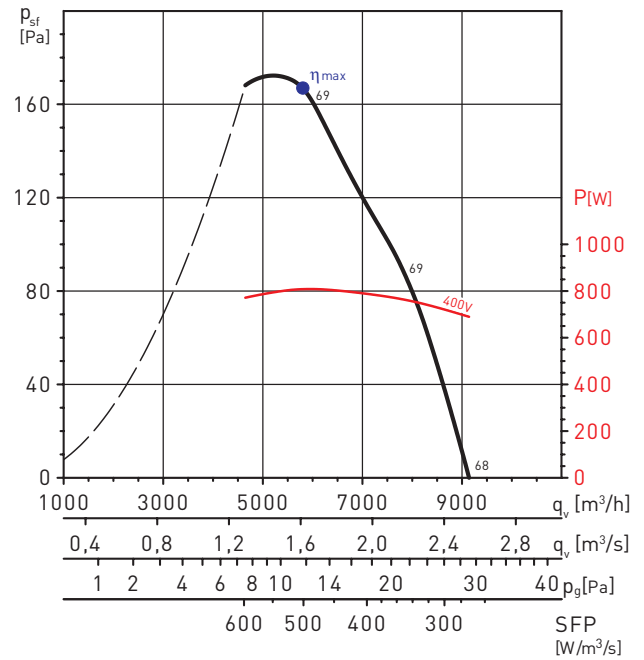

MC	EC	VSD	SR	$\eta$ [%]	N	[kW]	[m³/h]	[Pa]	[RPM]
A	Static	No	1	33,1	40,0	0,808	5793	167	1357

HCBT/4-560/H

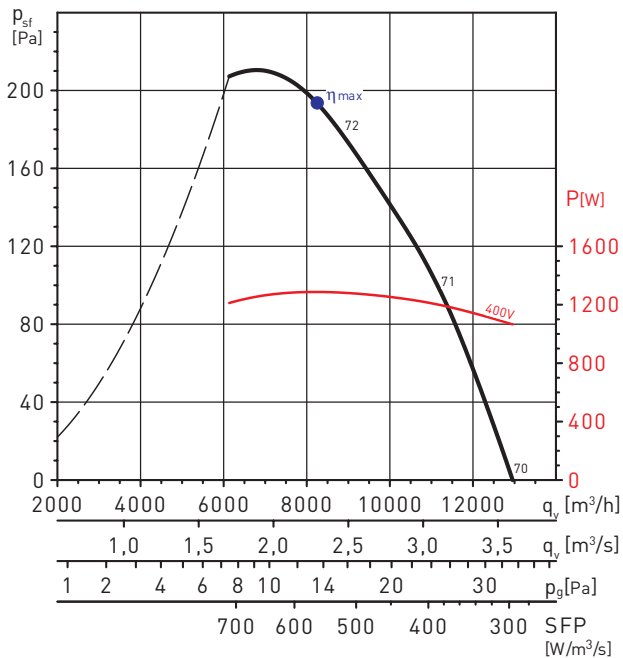

MC	EC	VSD	SR	$\eta$ [%]	N	[kW]	[m³/h]	[Pa]	[RPM]
A	Static	No	1	34,4	40,0	1,287	8244	194	1349

HCBT/4-630/H

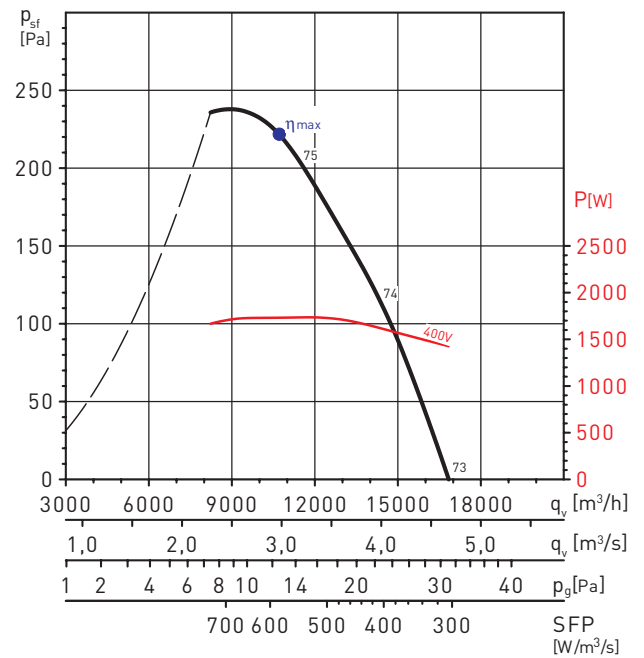

MC	EC	VSD	SR	$\eta$ [%]	N	[kW]	[m³/h]	[Pa]	[RPM]
A	Static	No	1	38,1	42,9	1,731	10708	222	1355

**PERFORMANCE CURVES - 4 POLE MOTORS**

HCBT/4-710/H

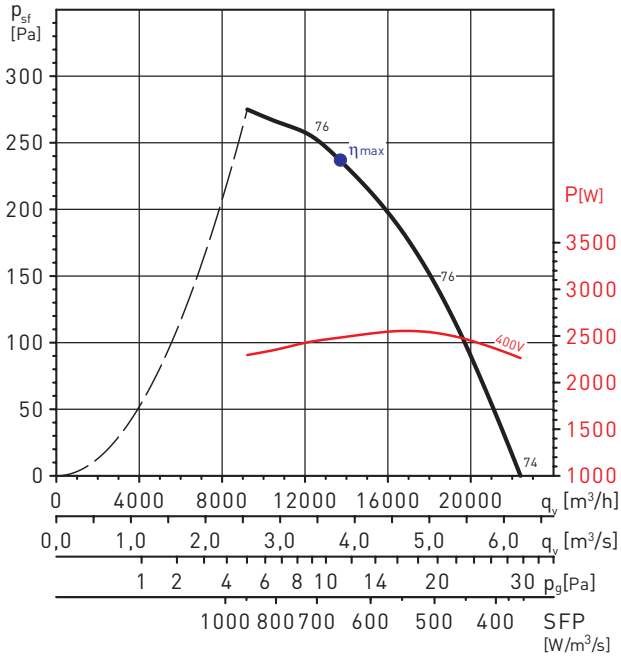

MC	EC	VSD	SR	$\eta$ [%]	N	[kW]	[m³/h]	[Pa]	[RPM]
A	Static	No	1	36,3	40,1	2,483	13700	237	1326

HCBT/4-800/L

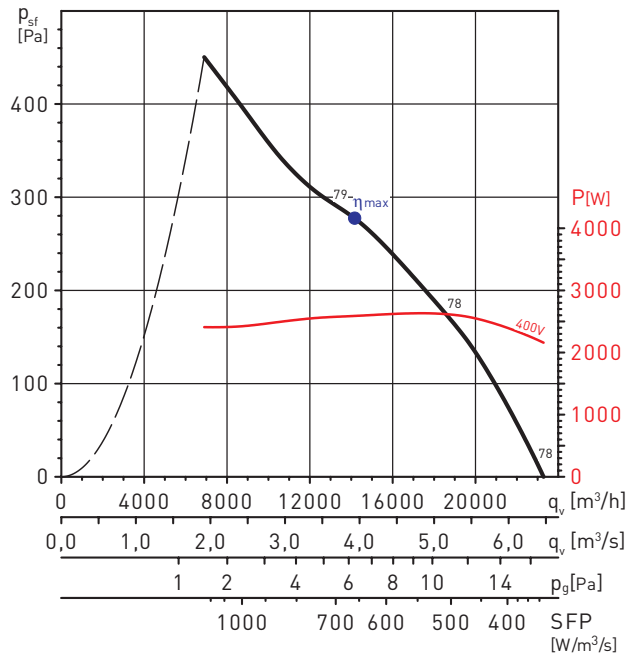

MC	EC	VSD	SR	$\eta$ [%]	N	[kW]	[m³/h]	[Pa]	[RPM]
A	Static	No	1	42,2	45,9	2,589	14152	278	1376

HCBT/4-800/H

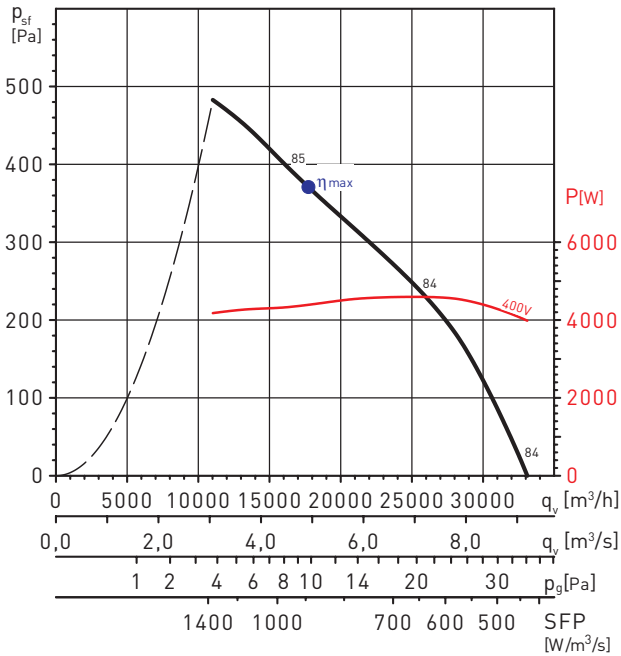

MC	EC	VSD	SR	$\eta$ [%]	N	[kW]	[m³/h]	[Pa]	[RPM]
A	Static	No	1	41,7	44,0	4,389	17734	371	1431

HCBT/4-900/L

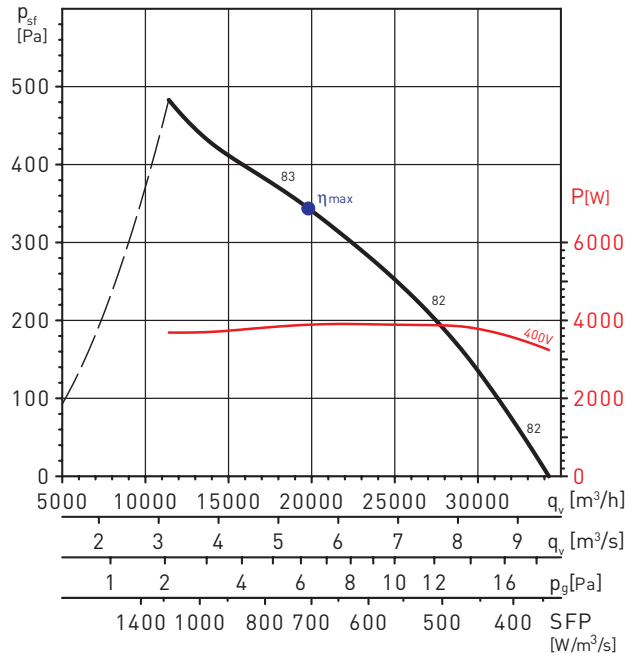

MC	EC	VSD	SR	$\eta$ [%]	N	[kW]	[m³/h]	[Pa]	[RPM]
A	Static	No	1	48,6	51,2	3,889	19789	344	1436



**PERFORMANCE CURVES - 4 POLE MOTORS**

HCBT/4-900/H

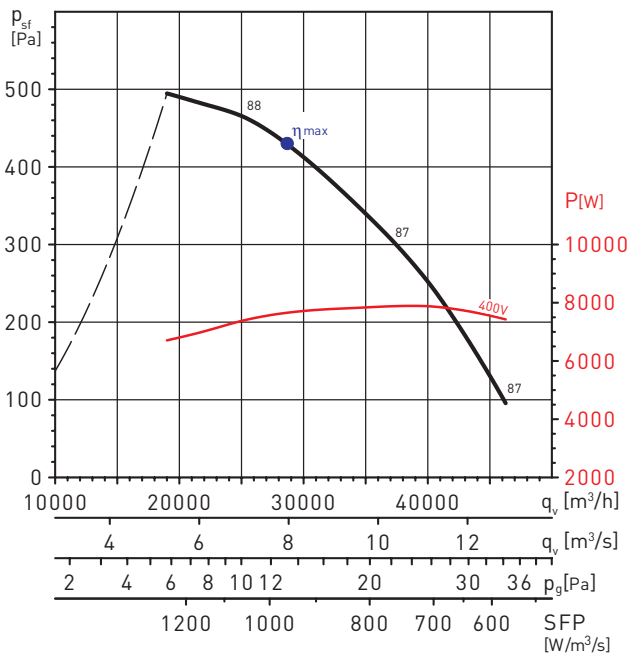

MC	EC	VSD	SR	$\eta$ [%]	N	[kW]	[m <sup>3</sup> /h]	[Pa]	[RPM]
A	Static	No	1	44,7	45,5	7,657	28654	430	1446

HCBT/4-1000/L

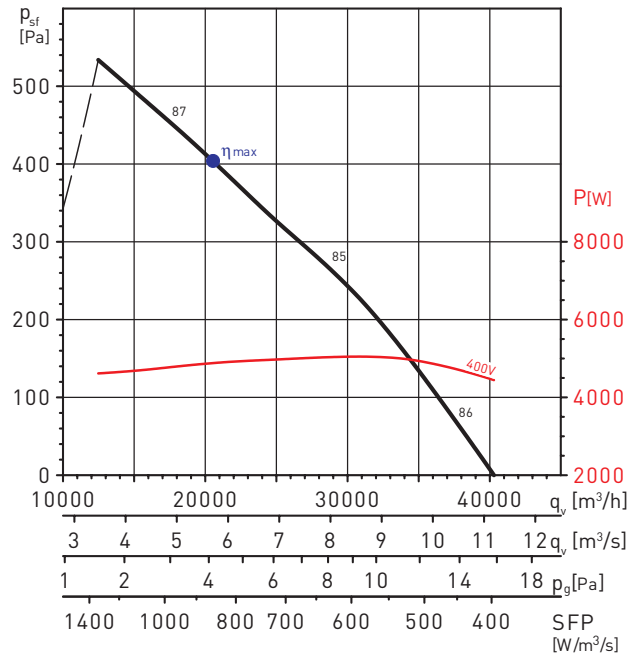

MC	EC	VSD	SR	$\eta$ [%]	N	[kW]	[m <sup>3</sup> /h]	[Pa]	[RPM]
A	Static	No	1	47,2	49,2	4,883	20544	404	1402

HCBT/4-1000/H

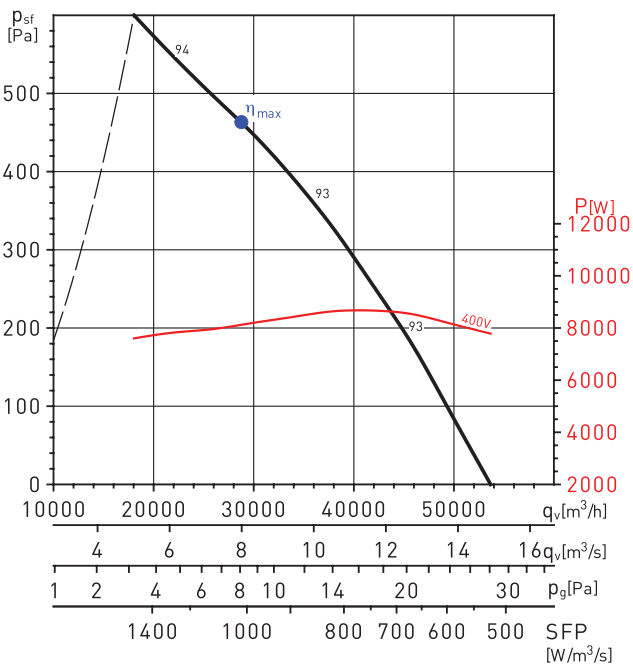

MC	EC	VSD	SR	$\eta$ [%]	N	[kW]	[m <sup>3</sup> /h]	[Pa]	[RPM]
A	Static	No	1	45,5	46,1	8,132	28765	463	1467

**PERFORMANCE CURVES - 6 POLE MOTORS**

HCBB/6-355/H

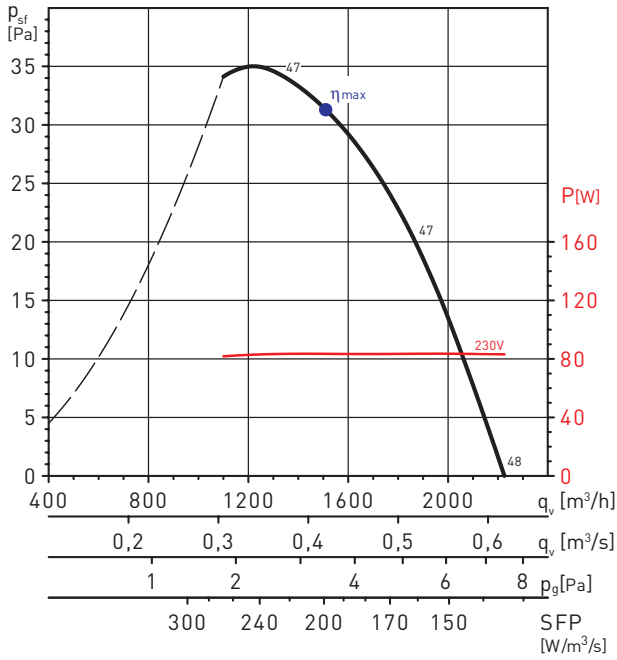

HCBB/6-400/H

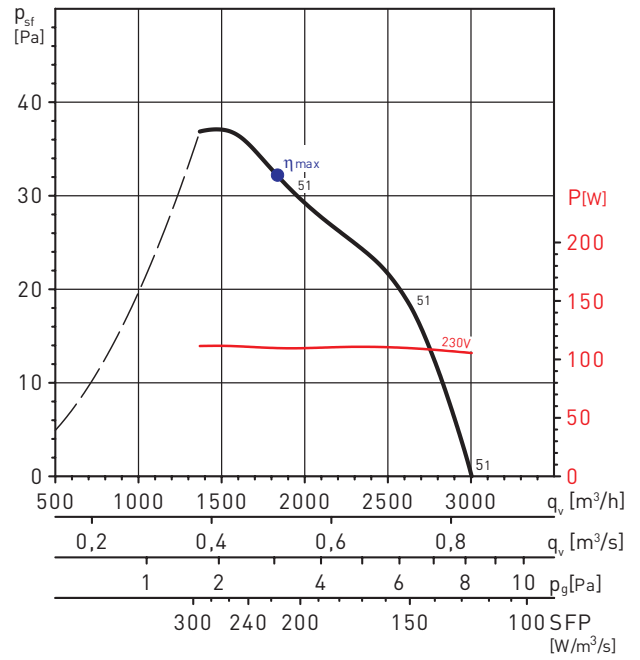

HCBB/6-450/H

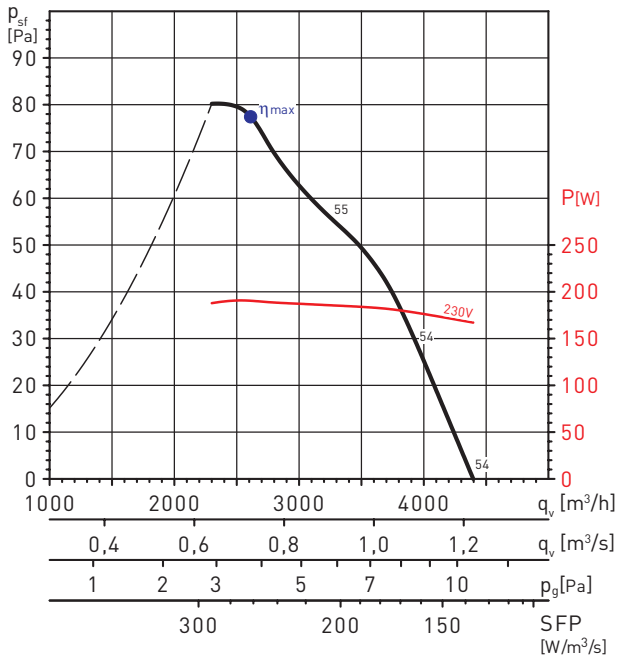

HCBB/6-500/H

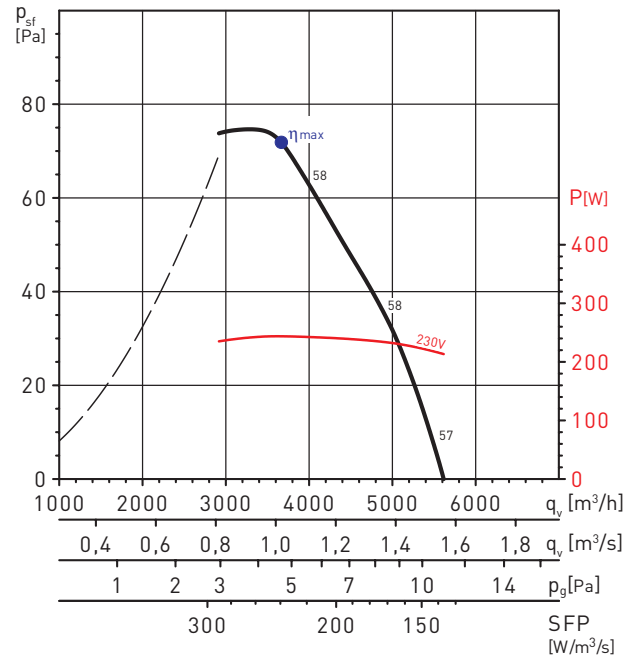

MC	EC	VSD	SR	$\eta$ [%]	N	[kW]	[m <sup>3</sup> /h]	[Pa]	[RPM]
A	Static	No	1	29,3	40,2	0,190	2604	77	908

MC	EC	VSD	SR	$\eta$ [%]	N	[kW]	[m <sup>3</sup> /h]	[Pa]	[RPM]
A	Static	No	1	29,9	40,1	0,244	3660	72	886

**PERFORMANCE CURVES - 6 POLE MOTORS**

HCBB/6-560/H

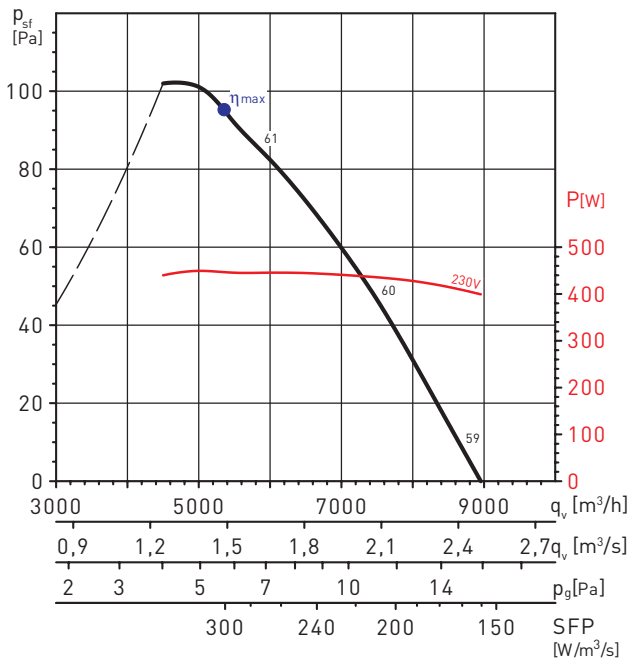

MC	EC	VSD	SR	$\eta$ [%]	N	[kW]	[m³/h]	[Pa]	[RPM]
A	Static	No	1	31,6	40,1	0,447	5347	95	903

HCBB/6-630/H

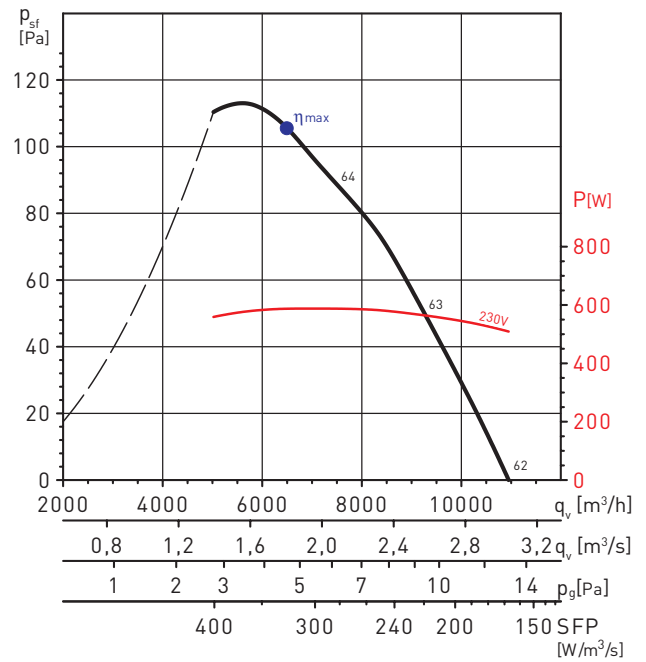

MC	EC	VSD	SR	$\eta$ [%]	N	[kW]	[m³/h]	[Pa]	[RPM]
A	Static	No	1	32,4	40,2	0,587	6492	106	888

HCBT/6-355/H

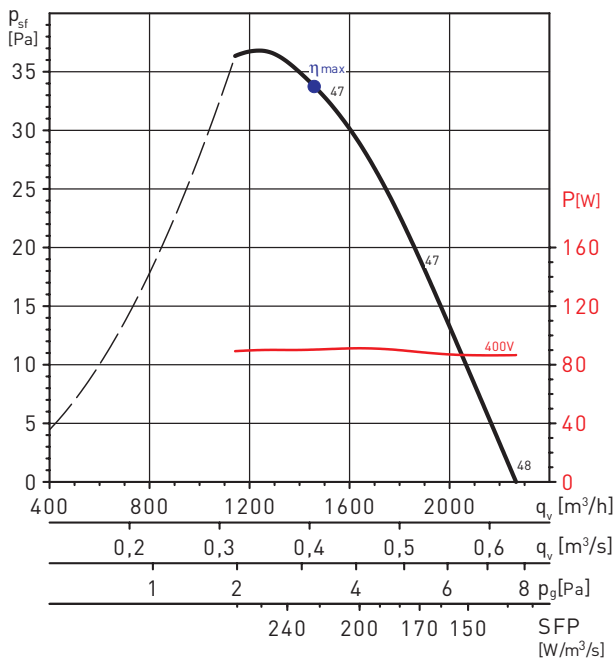

HCBT/6-400/H

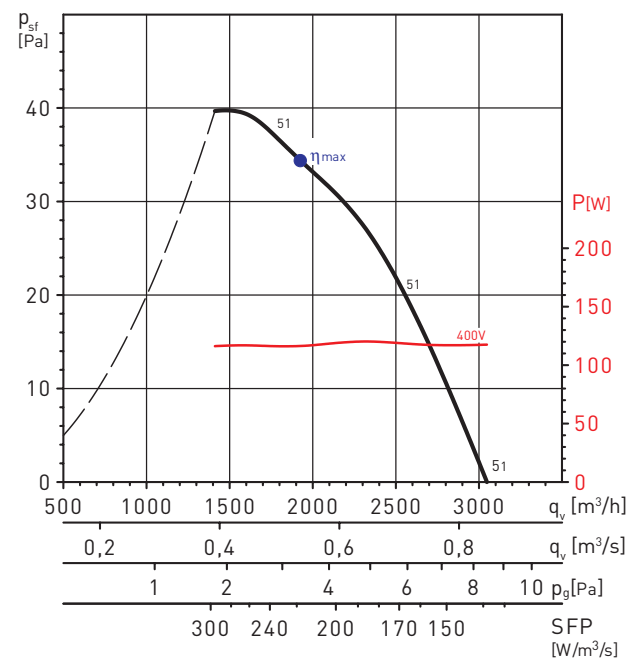

**PERFORMANCE CURVES - 6 POLE MOTORS**

HCBT/6-450/H

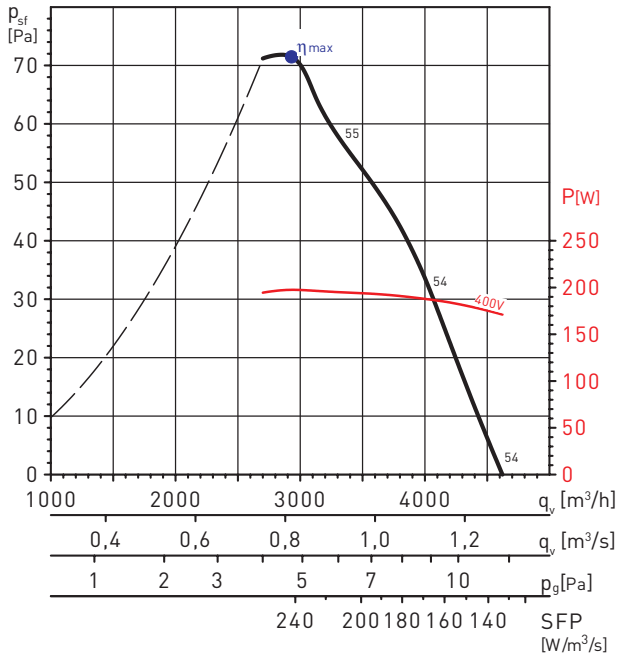

MC	EC	VSD	SR	$\eta$ [%]	N	[kW]	[m³/h]	[Pa]	[RPM]
A	Static	No	1	29,3	40,1	0,198	2925	71	904

HCBT/6-500/H

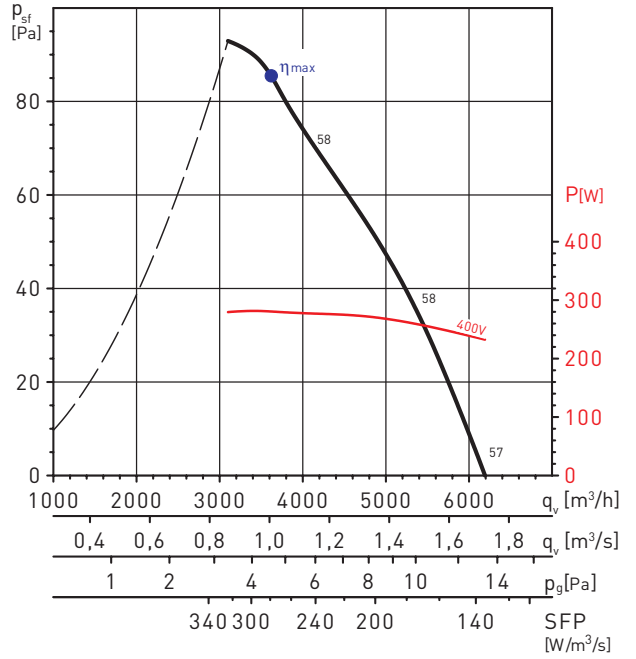

MC	EC	VSD	SR	$\eta$ [%]	N	[kW]	[m³/h]	[Pa]	[RPM]
A	Static	No	1	30,3	40,1	0,281	3613	85	874

HCBT/6-560/H

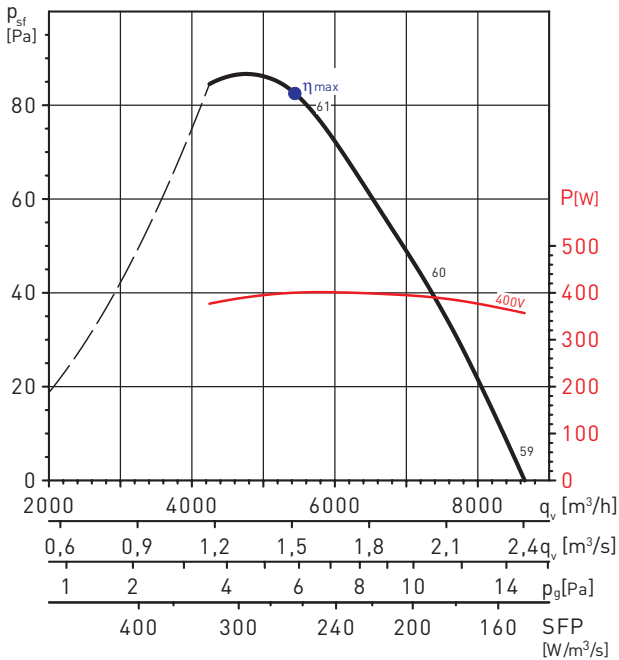

MC	EC	VSD	SR	$\eta$ [%]	N	[kW]	[m³/h]	[Pa]	[RPM]
A	Static	No	1	31,2	40,0	0,400	5444	83	876

HCBT/6-630/H

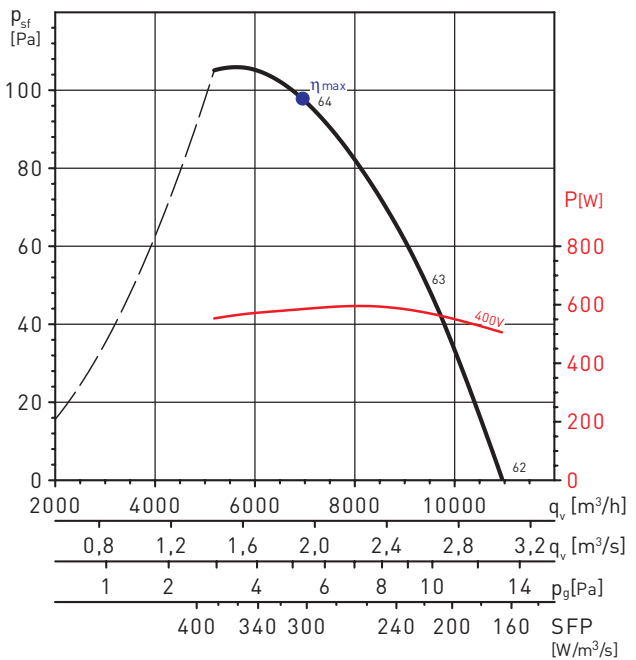

MC	EC	VSD	SR	$\eta$ [%]	N	[kW]	[m³/h]	[Pa]	[RPM]
A	Static	No	1	32,3	40,1	0,585	6954	98	889

**PERFORMANCE CURVES - 6 POLE MOTORS**

HCBT/6-710/H

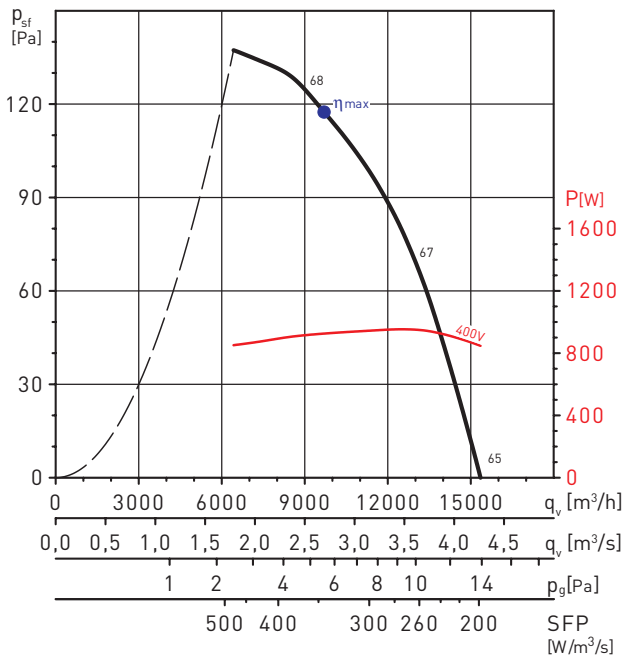

MC	EC	VSD	SR	$\eta$ [%]	N	[kW]	[ $m^3/h$ ]	[Pa]	[RPM]
A	Static	No	1	34,2	40,7	0,926	9683	118	946

HCBT/6-800/L

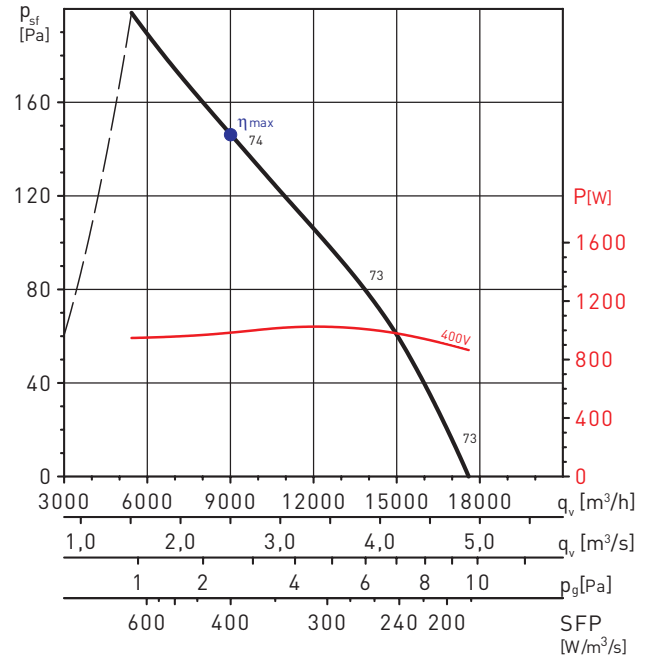

MC	EC	VSD	SR	$\eta$ [%]	N	[kW]	[ $m^3/h$ ]	[Pa]	[RPM]
A	Static	No	1	37,2	43,6	0,984	9004	146	927

HCBT/6-800/H

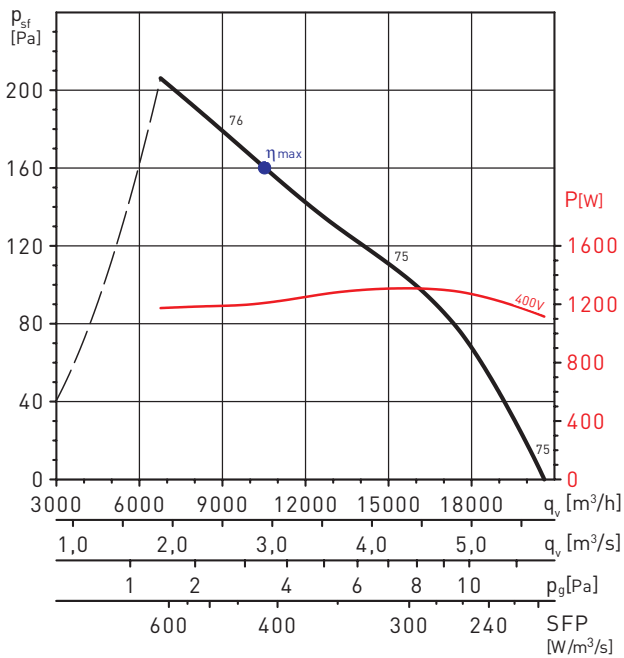

MC	EC	VSD	SR	$\eta$ [%]	N	[kW]	[ $m^3/h$ ]	[Pa]	[RPM]
A	Static	No	1	38,8	44,6	1,208	10519	160	923

HCBT/6-900/L

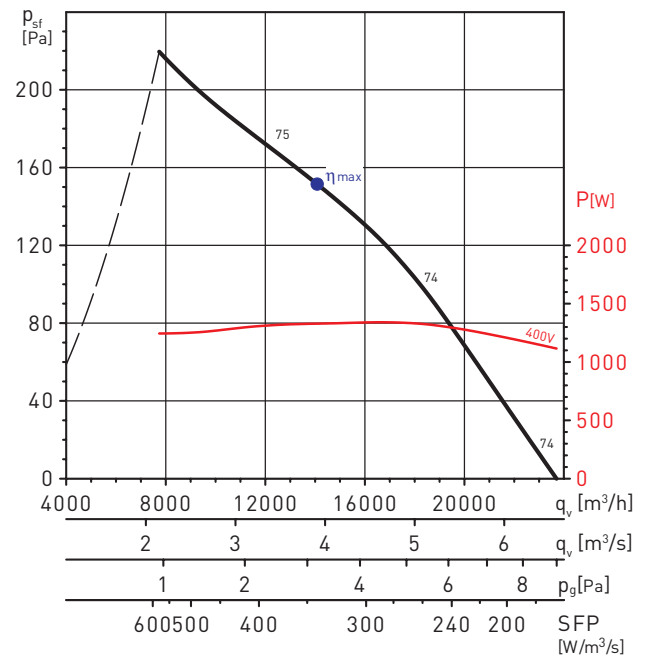

MC	EC	VSD	SR	$\eta$ [%]	N	[kW]	[ $m^3/h$ ]	[Pa]	[RPM]
A	Static	No	1	44,6	50,2	1,329	14066	152	953

**PERFORMANCE CURVES - 6 POLE MOTORS**

HCBT/6-900/H

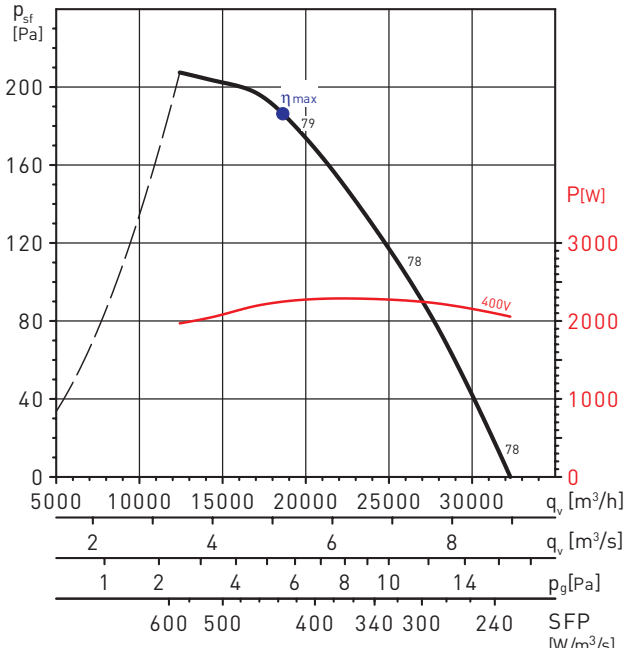

MC	EC	VSD	SR	$\eta$ [%]	N	[kW]	[m <sup>3</sup> /h]	[Pa]	[RPM]
A	Static	No	1	42,8	46,9	2,247	18590	187	943

HCBT/6-1000/L

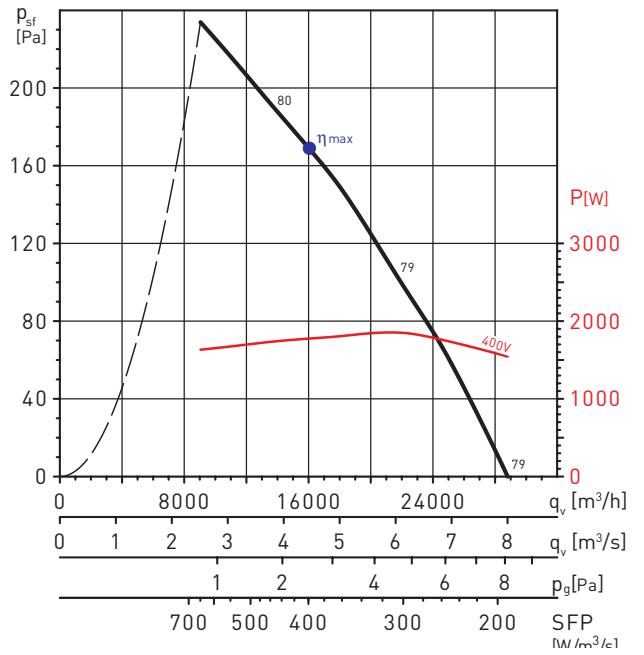

MC	EC	VSD	SR	$\eta$ [%]	N	[kW]	[m <sup>3</sup> /h]	[Pa]	[RPM]
A	Static	No	1	42,4	47,2	1,775	16021	169	927

HCBT/6-1000/H

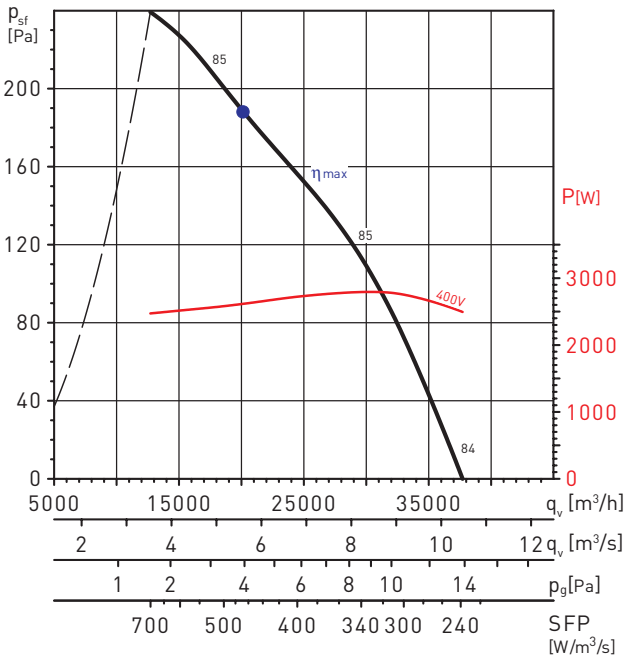

MC	EC	VSD	SR	$\eta$ [%]	N	[kW]	[m <sup>3</sup> /h]	[Pa]	[RPM]
A	Static	No	1	40,3	44,0	2,615	20140	188	929