

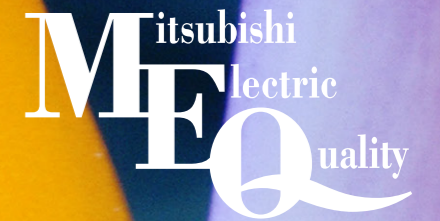

SPLIT-TYPE AIR CONDITIONERS

Changes for the Better



SPLIT-TYPE AIR CONDITIONERS Air to Water Catalogue 2022

MITSUBISHI ELECTRIC CORPORATION

**NOTICE**

- Do not install indoor units in areas (e.g. mobile phone base stations) where the emission of VOCs such as phthalate compounds and formaldehyde is known to be high as this may result in a chemical reaction.
- Our air-conditioning equipments and heat pumps contain a fluorinated greenhouse gas, R410A (GWP: 2088) or R32 (GWP: 675). \*These GWP values are based on Regulation (EU) No.517/2014 from IPCC 4th edition. In case of Regulation (EU) No.626/2011 from IPCC 3rd edition, these are as follows. R410A (GWP: 1975), R32 (GWP: 550)
- When installing or relocating or servicing our air-conditioning equipment, use only the specified refrigerant (R410A or R32) to charge the refrigerant lines.  
Do not mix it with any other refrigerant and do not allow air to remain in the lines.  
If air is mixed with the refrigerant, then it can be the cause of abnormal high pressure in the refrigerant lines, and may result in an explosion and other hazards.  
The use of any refrigerant other than that specified for the system will cause mechanical failure, system malfunction or unit breakdown. In the worst case, this could lead to a serious impediment to securing product safety.

**MITSUBISHI ELECTRIC CORPORATION**  
HEAD OFFICE: TOKYO BUILDING, 2-7-3 MARUNOUCHI, CHIYODA-KU, TOKYO 100-8310, JAPAN  
<http://Global.MitsubishiElectric.com/>

Wrap Yourself in Comfort and Quiet  
Eco-conscious Technologies from Japan

Air to Water Catalogue  
**2022**

Full Product Catalogue - Heating 2022 (Air to water)  
E-2203260(17360) sostituisce E-2203259(17331)





# Environmental Sustainability Vision 2050

## Environmental Declaration

Protect the air, land, and water with our hearts and technologies to sustain a better future for all.



Environmental Sustainability Vision 2050

To solve various factors that lead to environment issues, the Mitsubishi Electric Group shall unite the wishes of each and every person, and strive to create new value for a sustainable future.

## Three Environmental Action Guidelines

1

Apply diverse technologies in wide-ranging business areas to solve environmental issues

2

Challenge to develop business innovations for future generations

3

Publicize and share new values and lifestyles

## Key Initiatives

- Climate Change Measures
- Resource Circulation
- Live in Harmony with Nature
- Long-term Activities
- Innovation
- Nurturing Human Resources
- Understanding Needs
- Co-create and Disseminate New Values
- Live in Harmony with the Region

Heat pump technology inspires Mitsubishi Electric to design air conditioners that harmonize comfort and ecology.

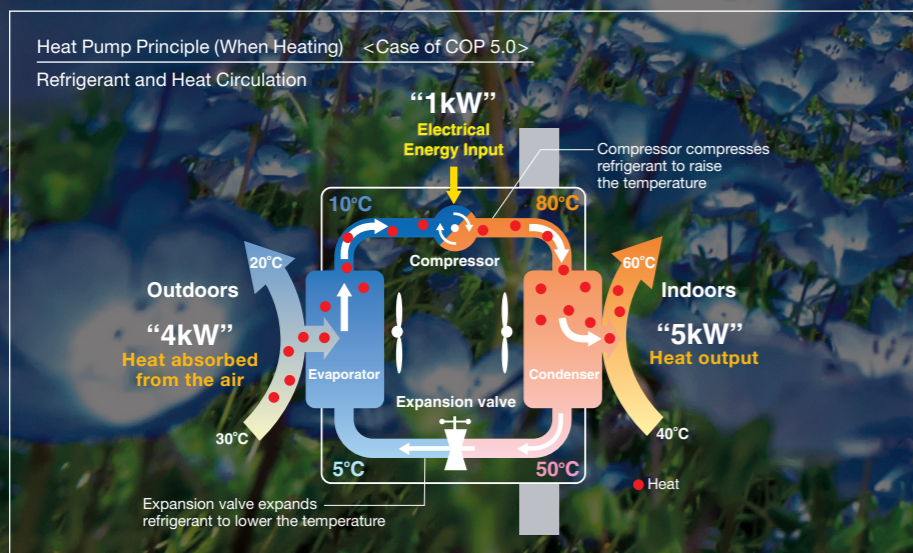

Mitsubishi Electric takes on the challenge of creating new value and contribute to a sustainable future in order to solve various environmental problems.

## Preventing Global Warming

Mitsubishi Electric is actively introducing R32 refrigerant which has a global warming potential approximately 1/3 that of R410A refrigerant. Not only by shifting from R410A to R32 but by decreasing the diameter of refrigerant piping, we are also striving to reduce the amount of refrigerant usage. Through these activities, we have achieved significant reduction in CO<sub>2</sub> equivalent amount compared to conventional models and realised minimizing the negative impact to the environment more than ever.

## Reducing the amount of refrigerant usage

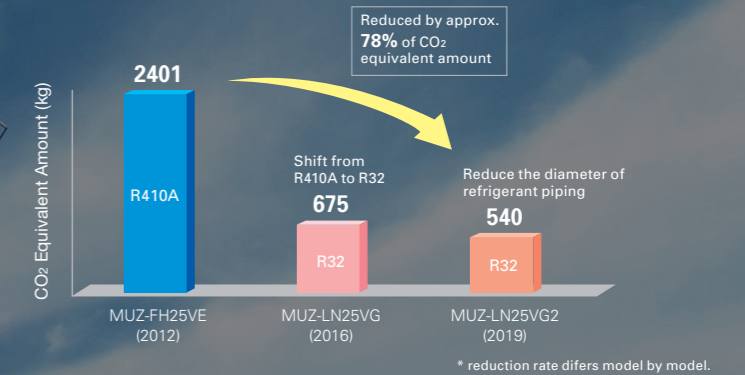

## Effective use of materials (Reduce & Recycle)

1. Accelerating the downsizing technology to reduce material use while balancing energy saving performance.
2. Designing products that are easy to separate and recycle.
3. All models are designed for WEEE and RoHS (II) compliance.\*

\*WEEE and RoHS directive: The Waste Electrical and Electronic Equipment (WEEE) Directive is a recycling directive for this type for equipment, while the Restrictions of Hazardous Substances (RoHS) Directive is an EU directive restricting the use of ten specified substances in electronic and electrical devices. In the EU, it is no longer possible (from July 2019) to sell products containing any of the ten substances.

## Balancing comfort and ecology

Mitsubishi Electric develops technologies to balance comfort and ecology, achieving greater efficiency in heat pump operation.

	Comfort	Ecology
1. Inverter	Faster start-up and more stable indoor temperature than non-inverter units.	Fewer On/Off operations than with non-inverter, saving energy.
2. 3D i-see Sensor	Since the positions of people can be detected, airflow can be set to personal taste, such as in airflow path or protected from the wind. The ability to adjust to individual preferences realizes more comfortable air conditioning.	Since the number of people in a room can be detected, energy-saving operation is adjusted or the power is turned off automatically. Efficient air conditioning with less waste is realized.
3. Flash Injection	Achieves high heating capacity even at low temperatures, plus faster start-up compared to conventional inverters.	Expands heat pump heating system to the cold regions to replace combustion heaters.
4. Dual Barrier Coating Dual Barrier Material	Prevents the indoor unit from getting dirty, delivering you clean air.	Keeping the inside of air conditioner clean leads to efficient operation and energy saving.



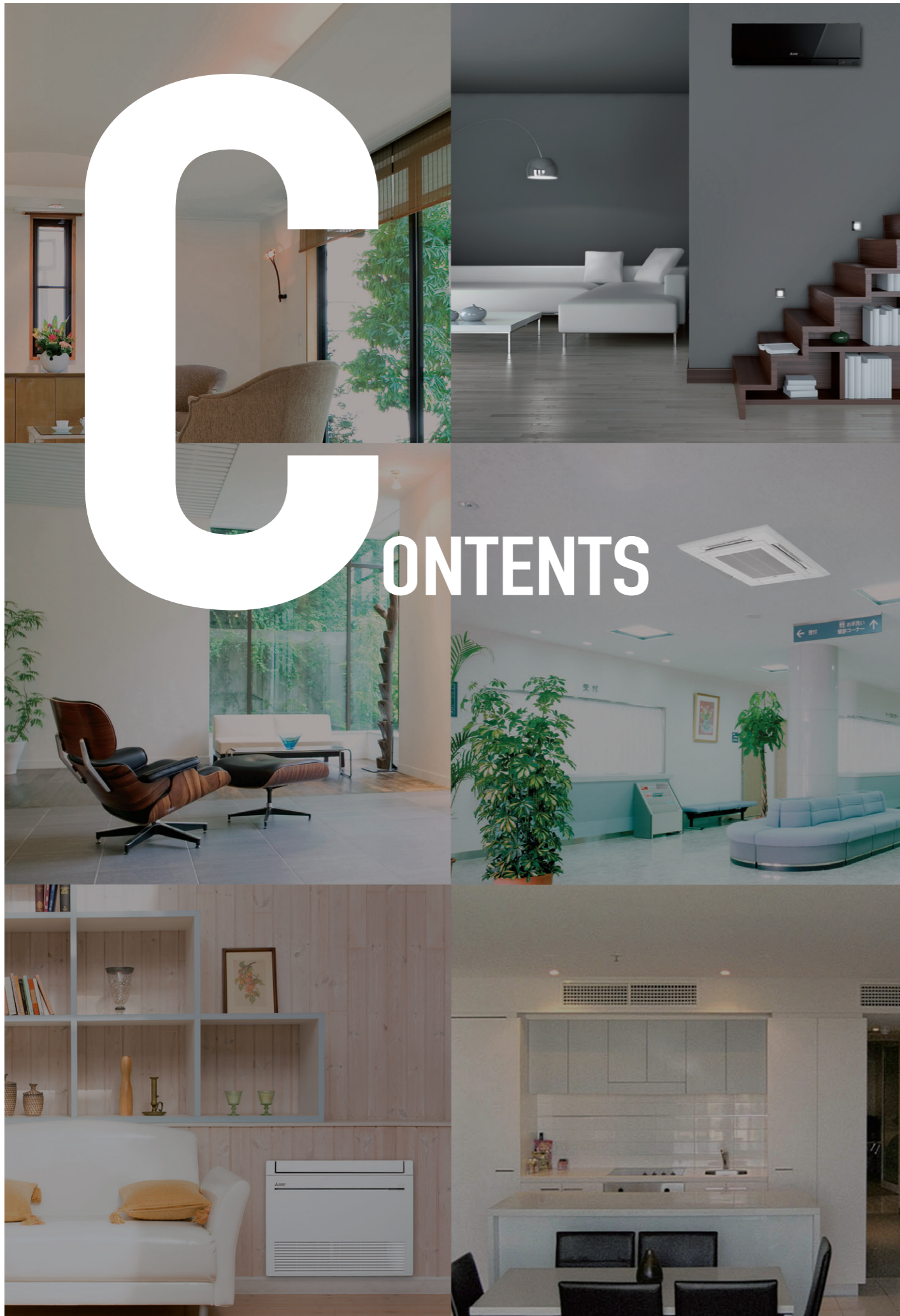

AIR TO WATER

■ FEATURES & SPECIFICATION ..... 007-043

# AIR TO WATER



**SELECTION** Choose the series that best matches the building layout.

Excellent ecodan's heating performance, even at low outdoor temperature!

R32	INDOOR UNIT		OUTDOOR UNIT		
	Hydrobox, Cylinder unit		Packaged type	Split type	
				Small capacity (Under 5kW)*  PUZ-HWM140	Medium capacity (6kW-14kW)*  PUZ-WM60/85/112
				 PUZ-WM50	 PUD-SHWM60/80/100/120/140
				Small capacity (Under 5kW)*  SUZ-SWM40/60	Medium capacity (6kW-14kW)*  SUZ-SWM80
					 SUZ-SWM80

\*Rated capacity is at conditions A2W35. (according to EN14511)

R410A	INDOOR UNIT		OUTDOOR UNIT			
	Hydrobox, Cylinder unit		Split type			
				Medium capacity (7.5kW-14kW)*  PUHZ-SHW80/112	 PUHZ-SHW140	Large capacity (≥16kW)*  PUHZ-SHW230
				 PUHZ-SW75/100	 PUHZ-SW120	 PUHZ-SW160/200

\*Rated capacity is at conditions A2W35. (according to EN14511)

Other ATW-related system	Mr.SLIM+	PUMY + ecodan	ecodan geodan
	<b>R410A</b>  PUHZ-FRP71	<b>R410A</b>  PUMY-P112/125/140	<b>R32</b>  EHGT17D-YM6ED



# New Eco-design Directive

## What is the ErP Directive?

The Eco-design Directive for Energy-related Products (ErP Directive) established a framework to set mandatory standards for ErPs sold in the European Union (EU). The ErP Directive introduces new energy efficiency ratings across various product categories. It affects how products such as computers, vacuum cleaners, boilers and even windows are classified in terms of environmental performance. Labelling regulations that apply to our ATW heat pumps came into effect from September 26, 2015, and then revised from September 26, 2019.

## New energy label and measurements

Under directive 2009/125/EC, ATW heat pumps of up to 70kW are required to show their heating efficiency on the energy label. The purpose of the energy label is to inform customers about the energy efficiency of a heating unit. The efficiency for space heating is ranked from A+++ to D (from September 2019). In the case of domestic hot water, it is from A+ to F (from September 2019).

### Product label

This label is for individual heating units, such as an ecodan heat pump. Typically, the space heater label is used for ecodan systems with a hydrobox, and the combination heater label is used for ecodan systems with a cylinder unit.

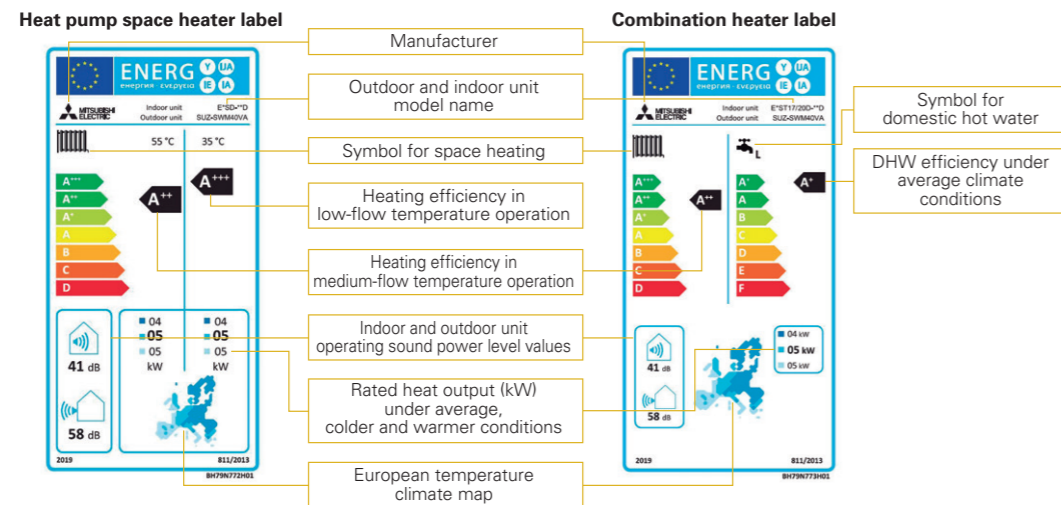

These labels are delivered with all ecodan outdoor units.

## What is the package label?

A heating system can use several energy-related products, such as a controller or solar thermal system. Therefore, a label showing the efficiency of the total heating system is required. The category range is defined from A+++ to G.

Creating the package label is the responsibility of the installers and distributors. A useful tool on the Mitsubishi Electric website is available to easily create the labels for ecodan products and controllers.

<http://erp.mitsubishielectric.eu/erp/options>

### Package label

This label is for heating systems that use several energy-related products, such as a controller or a solar thermal system.

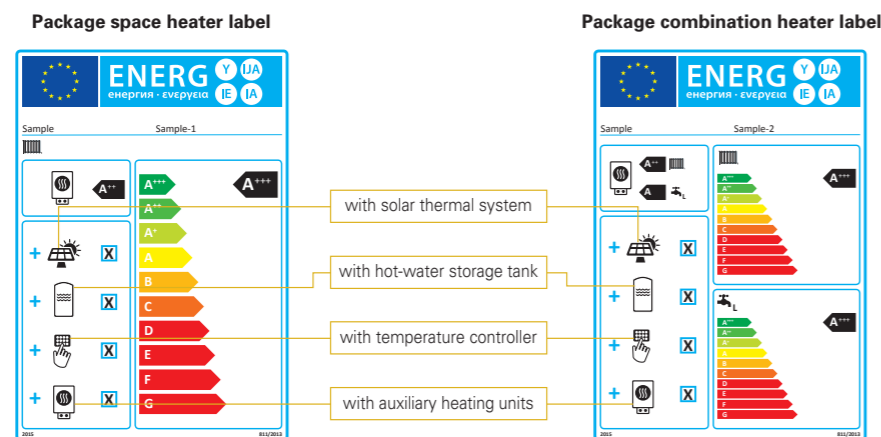

Customised package labels including ecodan heat pumps and the FTC6 controller can be created on the Mitsubishi Electric website.

# New R32 Eco Inverter Line-up

## Energy Efficient and Environmentally Friendly Heating

- Wide variety of product line with R32 refrigerant
- More energy efficient than conventional eco inverter models



## High Performance

All models have achieved the "RANK A+++ for SCOP at low temperature.

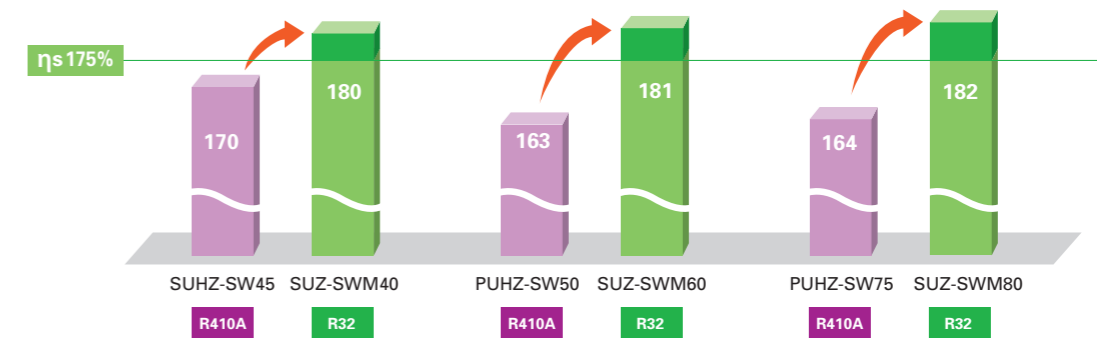

## Low Noise

Compared with conventional outdoor unit, New R32 eco inverter achieved lower noise level, assuring the flexibility of installation in dense residential areas.

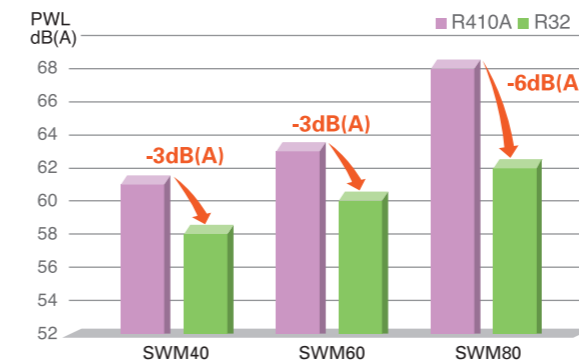

\*Compared SUZ-SWM40/60/80VA with SUHZ-SW45VA/PUHZ-SW50VKA/PUHZ-SW75VHA  
\*Rated condition (According to EN12102)

## 60°C Flow Temperature

Along with its increased lower operating range the New R32 range is capable of delivering a higher flow rate of 60°C, 5°C higher than the conventional model.

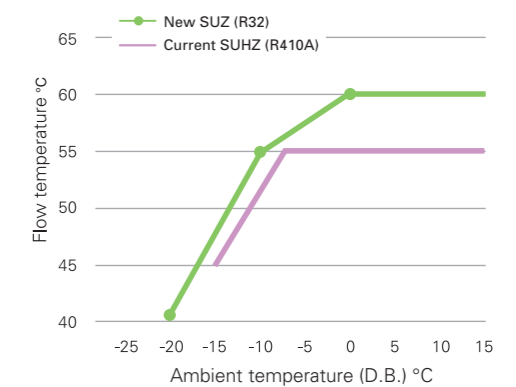

## Guaranteed Operating Range Expansion

Guaranteed heating operating range is extended to -20°C.

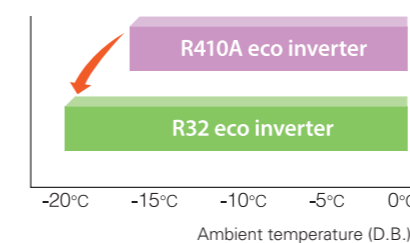

## Reducing Refrigerant Amount

<R410A vs R32> CO<sub>2</sub> equivalent emission

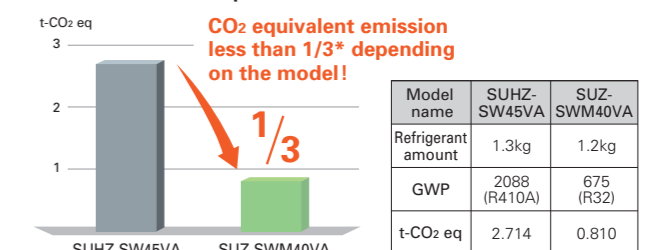

\*Source: IPCC 4th Assessment Report, global warming potential (GWP) 100-year value. Comparison of 2088 (R410A) and 675 (R32).



# Dedicated Heat Pump for Residence

## Stylish and Compact

### The Stylish Design and Compact Size Harmonises Residential Application

- Simple and elegant design by rounding left and right corners of the unit.
- Concealing the fan by matching the panel and the grille in dark colour.
- Unified shape and safety by setting the fan whole backwards and matching the grille on the same level of the front panel.
- Wider lineup with environmental-friendly R32 refrigerant.

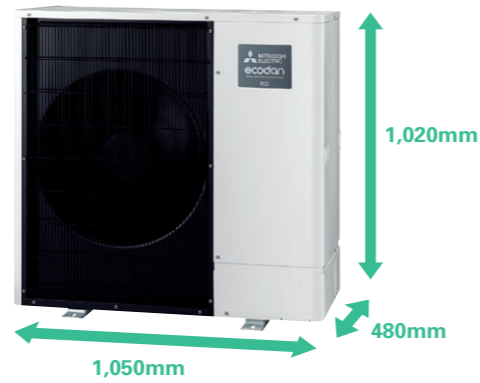

## High Performance

### New Compressor



- Compact
  - High performance
  - Flash injection\*
- \*ZUBADAN (SHWM) only

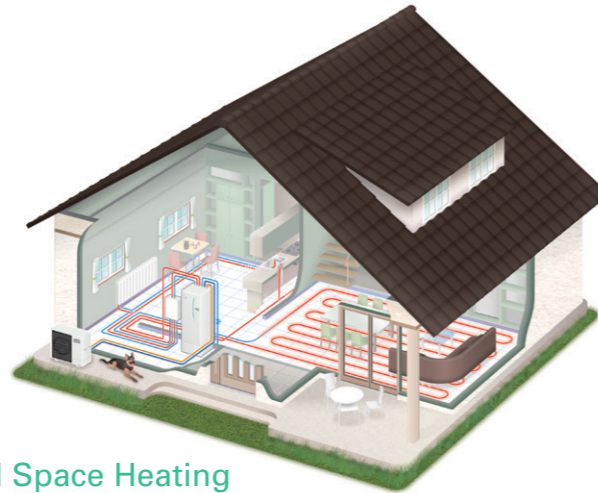

## ErP Lot 1 Compliant with Highest Seasonal Space Heating Energy Efficiency Class A+++

All models have achieved the "RANK A+++" for SCOP at low temperature.

### Heating

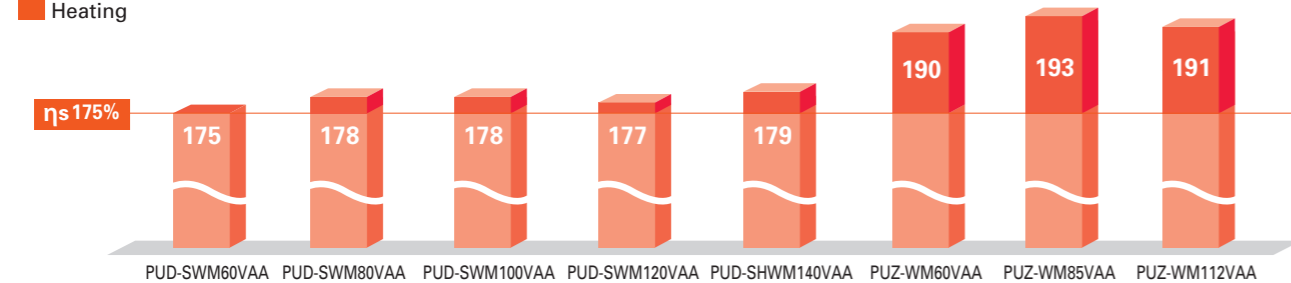

## 60°C Flow Temperature at Low Ambient Temperature

60°C max flow temperature can be maintained up to Ambient -7°C. (For PUD-S(H)WM models)

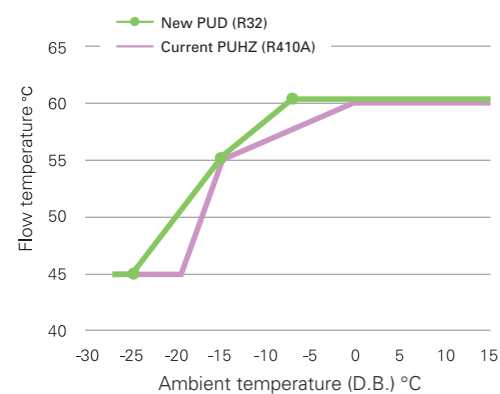

## Reducing Refrigerant Amount

### <R410A vs R32> CO<sub>2</sub> equivalent emission

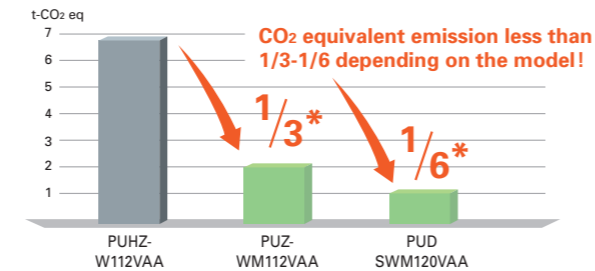

Model name	PUHZ-W112VAA	PUZ-WM112VAA	PUD-SWM120VAA
Refrigerant amount	3.3kg	3.0kg	1.6kg
GWP	2088 (R410A)	675 (R32)	675 (R32)
t-CO <sub>2</sub> eq	6.890	2.025	1.080

\*Source: IPCC 4th Assessment Report, global warming potential (GWP) 100-year value. Comparison of 2088(R410A) and 675 (R32).

## Compact with Silence

### Noise Reduction-10dB(A)

Mitsubishi Electric heat pumps are designed to give you highly efficient and eco-friendly heating with 10dB(A) less in PWL. Compared with conventional models.

\* Rated condition (According to EN12102)

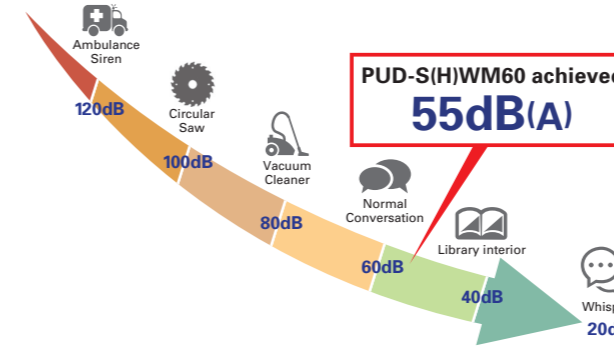

## Enclosing Noise

### Shutting Out Noise from Compressor

- The structure of double enclosing

Primary: enclosing a compressor (the structure is patented.)  
Secondary: enclosing machine room.



## New Control for Eco-friendly Heating

### Defrost Improvement

Conventional models often switch to defrost operation even when there is not much frost on outdoor units. By detecting frost more precisely, it is possible to prevent frequent on/off for defrosting and to give you more comfort.

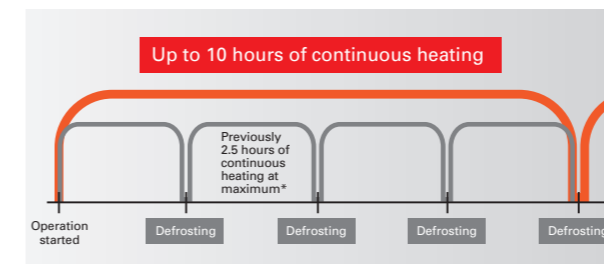

\*Comparison between prior PUHZ-SHW-AA model and new PUD-S(H)WM-AA model. Maximum number of operational hours at our Company's laboratory (external temperature -15°C). Hours of continuous operation may differ depending on external temperature conditions.

## Blowing Air

### To Reduce Fan Noise

- Optimising fan position
- Optimising bell mouth shape
- Bigger fan diameter

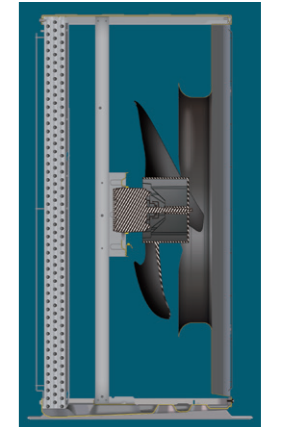

## Avoiding Vibration and Resonance

- Dedicated soft rubber mount for the compressor to avoid vibration.
- Optimising piping structure to avoid vibration and resonance.

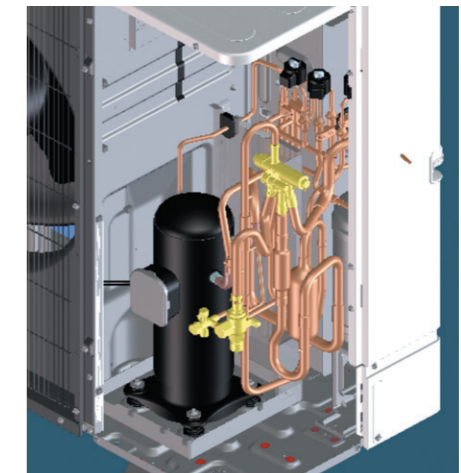

## New Compressor Frequency Control

By reducing frequency changes (from 17 to 4 times per hour), hunting is prevented. Reducing fluctuation improves efficiency and prolongs compressor life.

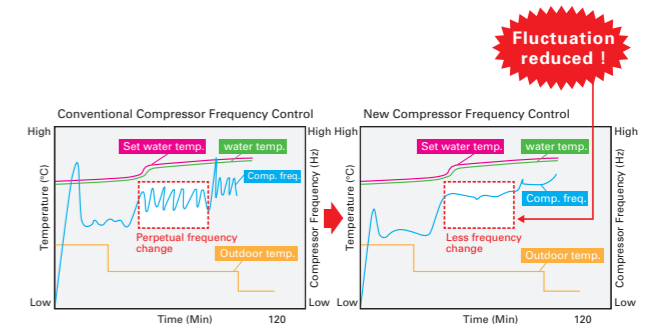

Fluctuation reduced!



## D generation Indoor Unit

### All-in-one Compact Indoor Unit

- All-in-one: Key functional components are incorporated
- Compact cylinder unit: 1,400~2,050mm in height
- Compact hydrobox: Only 530x360mm footprint
- Easy installation: Factory fitted pressure relief valve
- Easy service: Relevant parts are located at the front of the unit for easy maintenance
- Easy transport: Handles attached on front and back (cylinder unit)

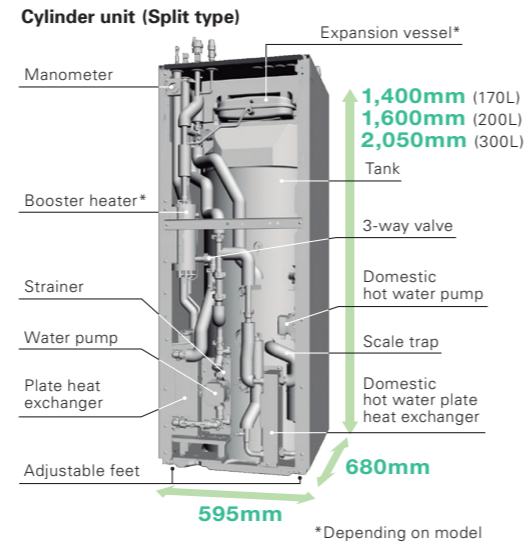
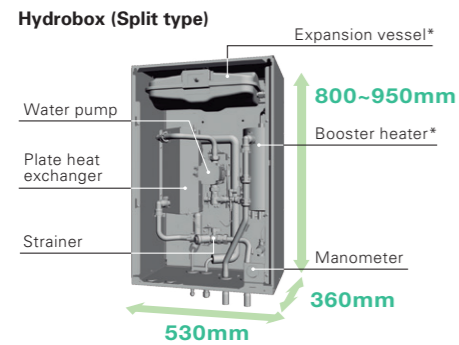

## Line-up

ecodan's line-up has many types of indoor units to satisfy diverse customers' needs, requests and local regulations. It includes various capacity units, with/without booster heater, with/without an expansion vessel, etc. In addition, a reversible hydrobox and a reversible cylinder unit are available.



### Available options

- Packaged or Split type
- With/without booster heater
- With/without expansion vessel
- Cylinder unit has an integrated 170L/200L/300L stainless steel tank
- Hydro box is control ready for domestic hot water with a stand-alone tank (locally supplied)

## Reversible Models

### (for heating/cooling)

### Perfect Comfort in Winter and Summer Time, Thanks to Our Reversible Models.

Reversible models are now available for both hydrobox and cylinder units (Both for split type and cylinder unit for packaged type). The new reversible cylinder is now able to produce cold water for cooling use and can alternatively produce domestic hot water in summer time.



## Easy Installation and Low Maintenance

### Simple Piping Arrangement

All water piping is aligned at the rear side of the unit for easy connection and neat finish.



### Built-in Drain Pan for Reversible Cylinder Models

Reversible models now include a built-in space saving drain pan and the drain socket is positioned at the back of the unit. With use of the adjuster bolt, the outlet height can be higher than 50mm, allowing 5m drainage.

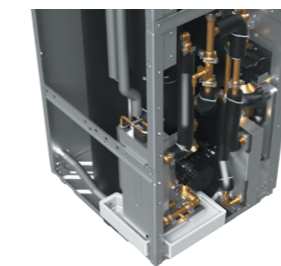

### Hydrobox Piping Arrangement Improvement

Through structural innovation related to the space around the pipes, the area where the spanner can be moved has been increased, thus improving pipe work and enabling it to be completed smoothly.

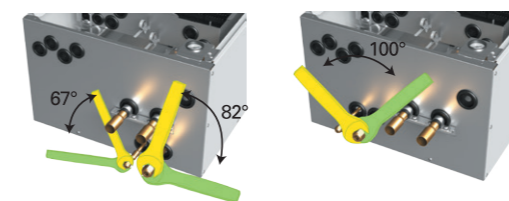

### Minimum Additional Water Required

In average/warmer conditions, minimum additional water is required for outdoor unit. If there is enough water amount inside water pipe, radiator, or underfloor heating no buffer tank is required. \*Refer to the indoor unit installation manual for specific outdoor unit models.

### Easy Adjustment

Adjust bolt capable of 50mm expansion for easy installation on uneven surfaces.



### Initial Setting Wizard

In addition to language, date and time, you can set up hot water and heating/cooling operation, pump speed, flow rate range initial setting much simpler than previous models.

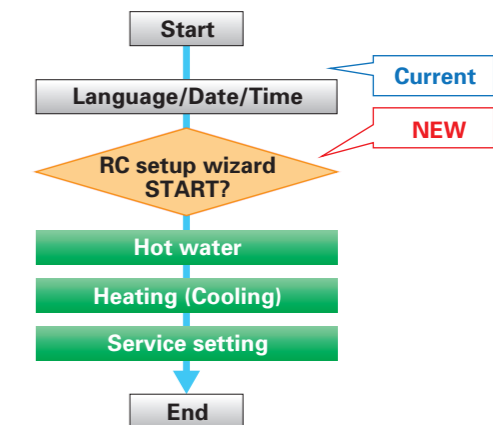

### Operation Data Monitoring

Time, operation mode, flow/return/tank temperature, can be displayed on main remote controller.

Sample display of monitoring setting

26 Feb 2019 10:00				
	THW1	THW2	THW5	Flow
10:00	☀ 41°C	☀ 38°C	☀ 54°C	20L
9:55	☀ 38°C	☀ 38°C	☀ 54°C	20L
9:50	☀ 48°C	☀ 48°C	☀ 54°C	20L
9:45	☀ 60°C	☀ 56°C	☀ 54°C	15L
9:40	☀ 59°C	☀ 55°C	☀ 52°C	15L

Navigation icons: i, left arrow, right arrow, (1/5)

### 2 Zone Kit

- You can select from 3 types of pump operations, 1. Fixed speed mode, 2. Fixed pressure mode, 3. Energy saving mode, depending on your preference.



- All-in-one kit: Key functional components are incorporated in 2 zone kit.
- Easy installation: G1 screw type flexi-piping to avoid brazing.
- Compact size: Just to fit on the top of cylinder unit, also wall mountable.



## High Performance Improved Efficiency

With additional thermistor (THW5A),  $\eta_{wh}$  [%] rating is improved by more than 40% compared to previous C generation 200L models allowing 170L and 200L to achieve A+, the highest possible domestic hot water efficiency rank.

Excellent DHW efficiency



	170L	200L	300L
	$\eta_{wh}$ [%]	$\eta_{wh}$ [%]	$\eta_{wh}$ [%]
Conventional	-	96~104	-
New	120~148	135~159	118~128
Load Profile	L	L	XL
DHW Rank	A+	A+	A/A+

## Thermistor Position of Cylinder

The thermistor position is now selectable allowing the unit to accommodate for different water demands in order to maximise the efficiency of the unit for any size of household or application. Using two thermistors equipped with all sizes of tanks, you can now select the DHW recharge amount from two options (Standard/Large). It helps accommodate for different water demands in order to maximise the efficiency of the unit for any size of household or application. This mode can be selected from main remote controller.

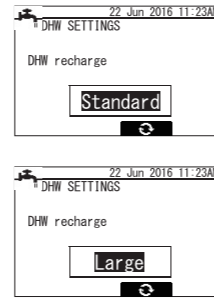

## Unique Technology of ecodan

### Auto Adaptation

#### Maximise Energy Savings While Retaining Comfort at All Times

Regarding the relation of flow temperature and unit performance, a 1°C drop in the flow temperature improves the coefficient of performance (COP) of the ATW system by 2%. This means that energy savings are dramatically affected by controlling the flow temperature in the system.

In a conventional system controller, the flow temperature is determined based on the pre-set heat curve depending on the actual outdoor temperature. However, this requires a complicated setting to achieve the optimal heat curve.

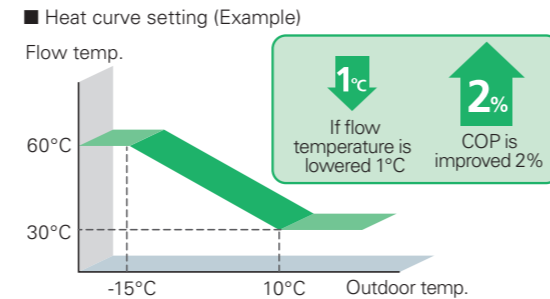

### Auto Adaptation Improvement

#### Mitsubishi Electric's Auto Adaptation Function Automatically Tracks Changes in the Actual Room Temperature and Outdoor Temperature and Adjusts the Flow Temperatures Accordingly.

Aiming to realise further comfort and energy savings, Mitsubishi Electric has already introduced a revolutionary new controller. Auto Adaptation function measures the room temperature and outdoor temperature, and then calculates the required heating capacity for the room. Simply stated, the flow temperature is automatically controlled according to the required heating capacity, while optimal room temperature is maintained at all times, ensuring the appropriate heating capacity and preventing energy from being wasted.

Furthermore, by estimating future changes in room temperature, the system works to prevent unnecessary increases and decreases in the flow temperature. Accordingly, Auto Adaptation maximises both comfort and energy savings without the need for complicated settings.

For Mitsubishi Electric ecodan, by introducing improved control logic, we achieved faster heating and more energy saving.

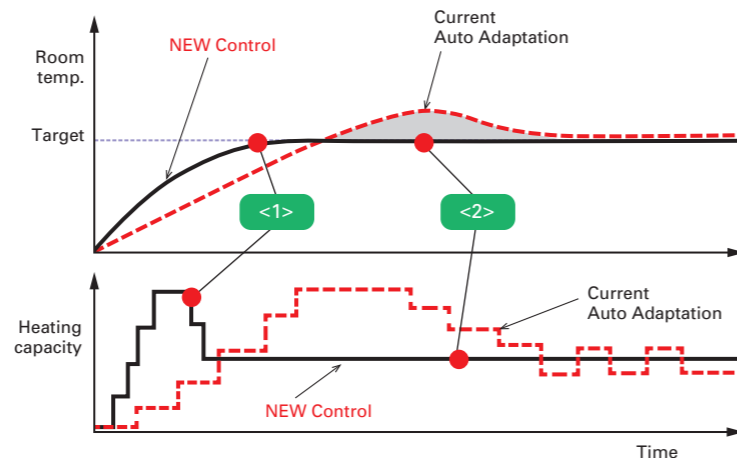

<1> Fast heating with improved accuracy in learning building heat load  
<2> Energy saving by avoiding over heating and capacity fluctuation with better control response, i.e. control interval and resolution

## Smart Grid Ready Function

In recent years renewable energy generation has become popular. However, this rapid growing causes the problem of supply and demand gap of electricity. The aim of "SG Ready" is to make the electricity demand response more flexible by creating a uniform interface for the smart grid integration of heat pumps. Air-to-Water units need to be able to change the operation pattern when the signal is received from the Smart Grid Controller.

New ecodan Cylinder, Hydrobox and FTC have been modified to communicate with Smart Grid Controller. The communication protocol is based on "SG Ready" label regulation. (Version 1.1; gültig ab 01.01.2013)

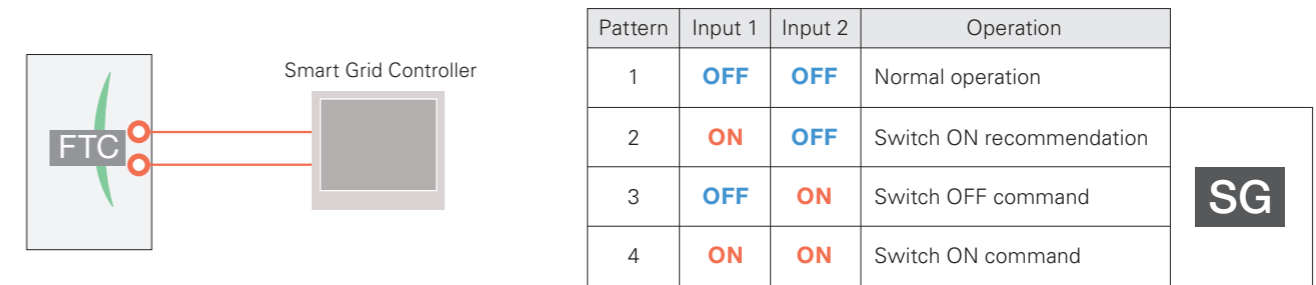

#### Pattern 1: Normal operation

When there is no signal from the Smart Grid Controller, DHW and Heating operate according to user settings.

#### Pattern 2: Switch ON recommendation

When set to the "Switch ON" recommendation, the target temperature of DHW is increased a specified amount and the heating "Thermo ON" condition range is extended.

#### Pattern 3: Switch OFF command

When the "Switch OFF" command is received, both DHW and Heating are turned off.

#### Pattern 4: Switch ON command

When the "Switch ON" command is received, the target temperature of DHW is increased to the maximum target temperature and Heating continues.

## Improved Smart Grid Ready

SG ready icon on main remote controller indicates that SG ready is active and its setting can be easily operated with main remote controller. Improved SG ready function enables you to choose the target temperature in unit of 1°C. Also, when PV manager is interlocked with ecodan and ecodan receives its signal, heat is stored as much as possible while heat pump and/or electric heater running.

Heat storage in large buffer tank will be made available for zone2 as well when peak cut signal is on. As long as a mixing valve keeps its control, zone2 flow temperature is maintained.

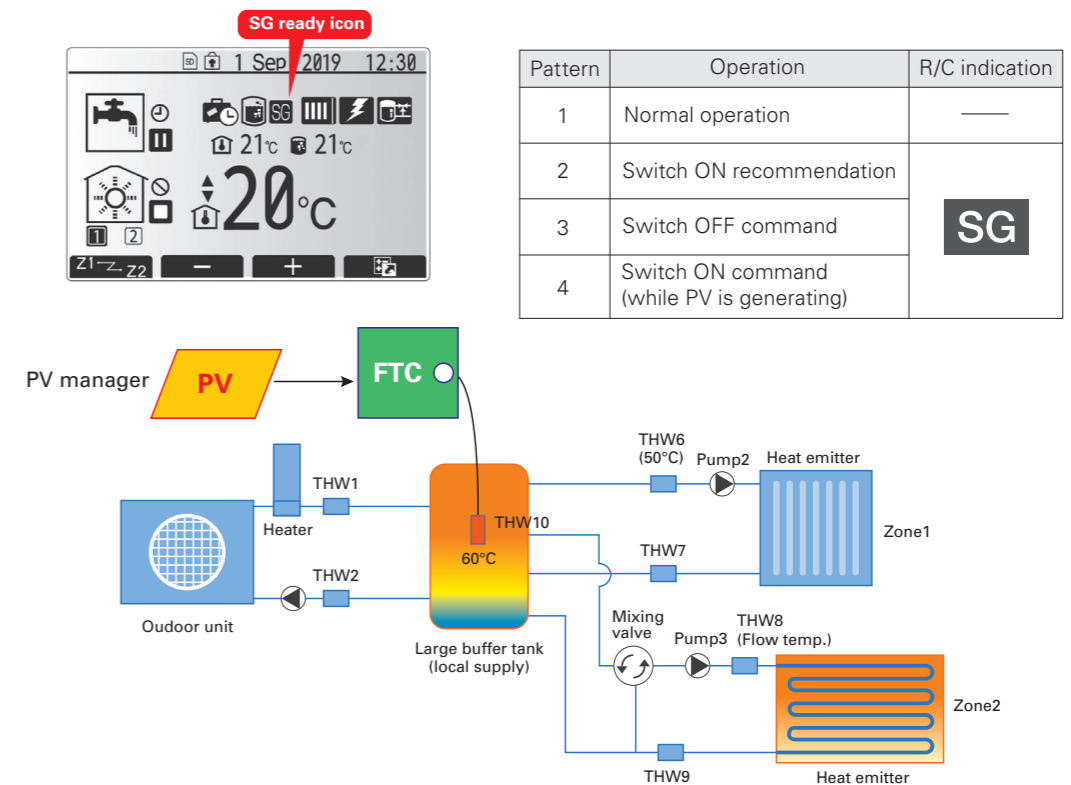

Pattern	Operation	R/C indication
1	Normal operation	—
2	Switch ON recommendation	SG
3	Switch OFF command	
4	Switch ON command (while PV is generating)	





## Intelligent Hybrid Control (boiler interlock)

### An Existing Boiler Can Be Used for Extra Heating Capacity in an Efficient Way

The flexibility of ecodan's intelligent control allows the system to be combined with the boiler currently in use. Additionally, this control can judge which heating source to use either ecodan or the existing boiler, based on various conditions\*. In the event of one heating unit not working due to some unforeseen problem, the other heating system can be used as a back-up, thereby preventing the heating system operation from stopping completely.

\*Please see below "Heat source switchover".

### Intelligent system combining a boiler with ecodan

#### Intelligent boiler interlock system

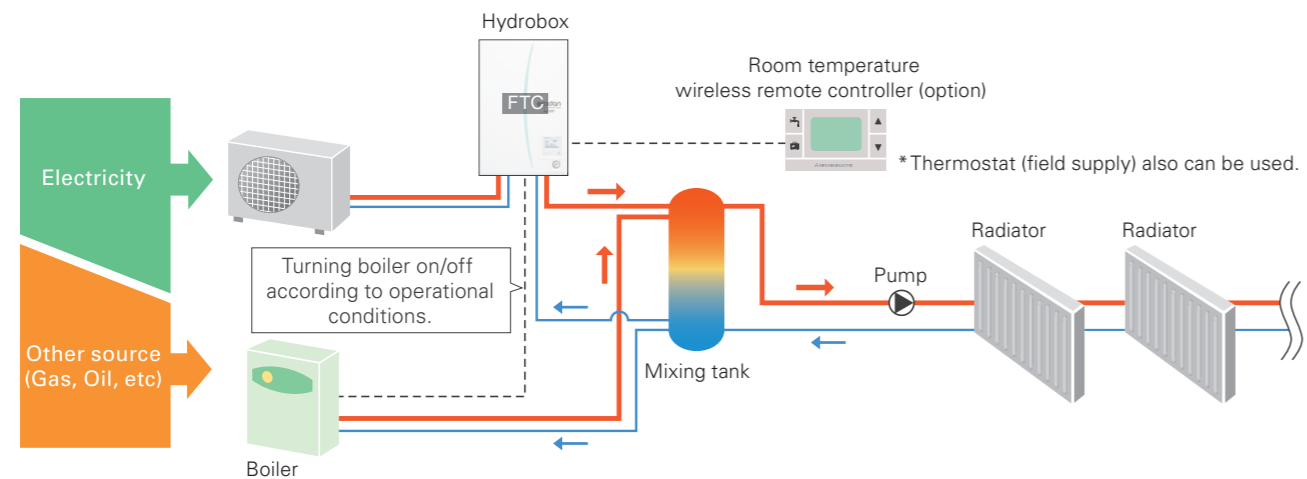

\* Items such as a mixing tank, and pump are not included and need to be purchased locally.

### Heat source switchover - Choose appropriate system based on needs

#### 4 types of heat source switchover logic

- ① Switchover based on actual outdoor temperature
  - Heat source switchover occurs when the outdoor temperature drops below a pre-set temperature.
- ② Switchover based on running cost
  - Heat source switchover occurs by judging optimal operation based on running cost.
  - \*Pre-registration of the energy price of electricity, and gas or oil per 1kWh is necessary.
- ③ Switchover based on CO<sub>2</sub> emission level
  - Heat source switchover occurs to minimise CO<sub>2</sub> emission.
  - \*Pre-registration of CO<sub>2</sub> emission amount from electricity and gas or oil is necessary.
- ④ Switchover can also be activated via external input
  - For example, the peak cut signal from electric power company.

## 2 Zone Control (for heating/cooling)

### Improved Simultaneous Control of Two Different Zones

Using ecodan, it is possible to control two different flow temperatures, thereby managing two different heating load requirements. The system can adjust and maintain two flow temperatures when different temperatures are required for different rooms; for example, controlling a flow temperature of 40°C for the bedroom radiators and another flow temperature of 30°C for the living room floor heating. Moreover, mixing valve control is advanced for improving zone 2 comfort by using heat storage in buffer tank. Also, new controller monitors the temperature inside buffer tank and prioritizes using the heat inside the tank to avoid frequent on/off operation when using 2 zone control.

#### Two temperature zones

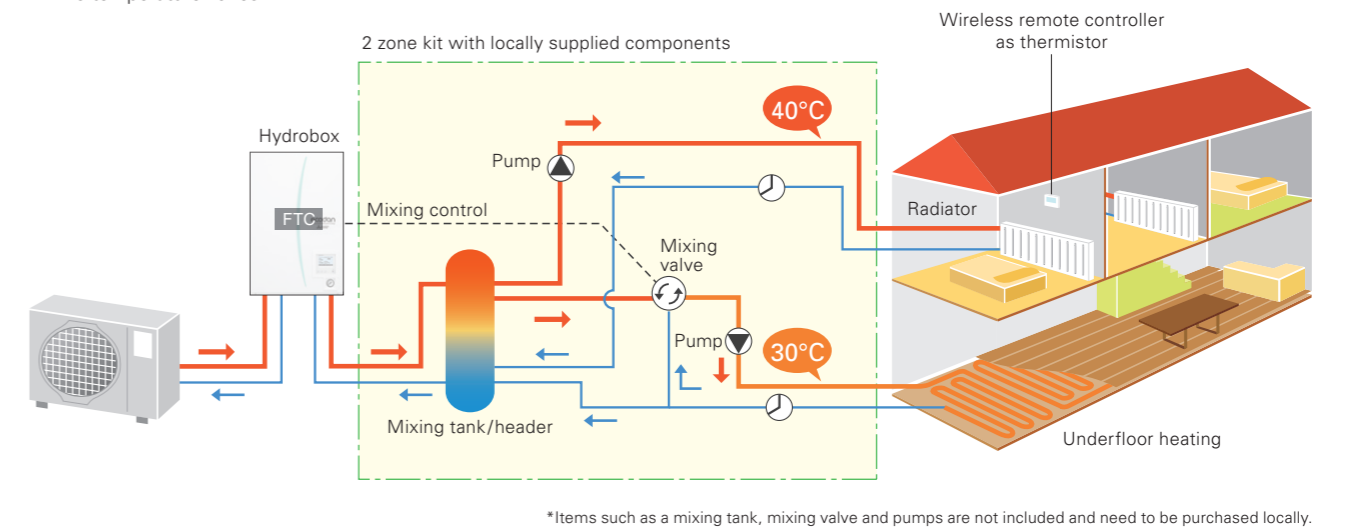

## Multiple Unit Control

### Connect up to 6 Units – Automatic Control of Multiple Units for Bigger Capacity and Better Efficiency

A maximum of 6 units\* can be configured according to the heating/cooling load of the building. The most efficient number of operating units is determined automatically based on heating/cooling load. This enables ecodan to provide optimal room temperature control, and thus superior comfort for room occupants. Also incorporated is a rotation function that enables each unit to run for an equal time period. If one of the units malfunctions when using the Multiple Unit Control, another unit can be automatically operated for back-up, thereby preventing the system operation from stopping completely.

\*Only same models (same capacity) can be used.

#### Multiple unit control

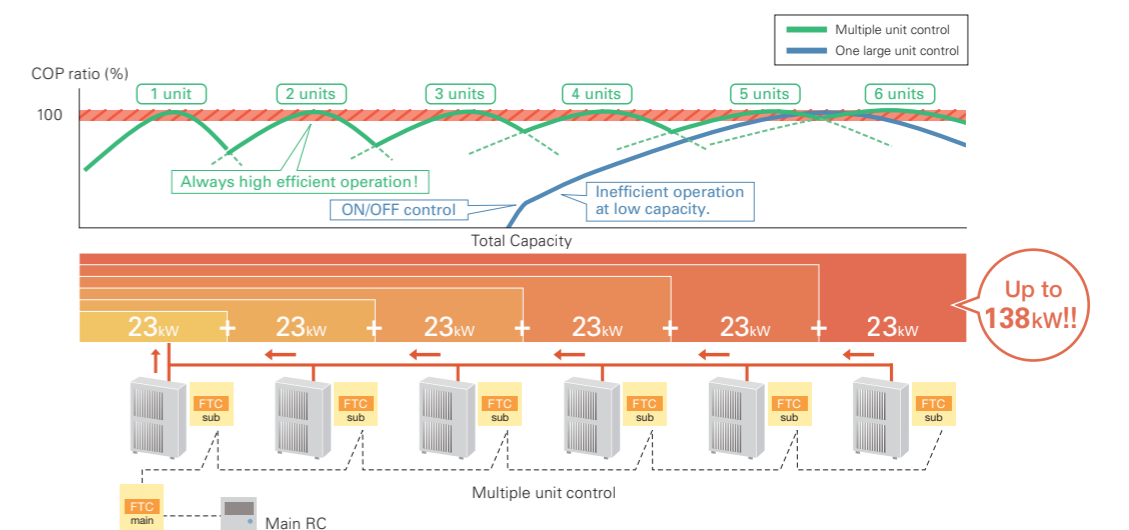



## Remote Controllers

### Smart User-friendly Controller with Stylish Design

#### Main remote controller

- Large screen and backlight for excellent visibility, even in dark environment
- Multi-language support (supports 15 languages)
- Can be removed from main unit and installed in a remote location (up to 500m)
- Quick reading of operation data (7.5 times faster than previous model)
- Wide range of convenient functions in response to user demand

#### Function settings

- Energy monitoring
- Two-zone control (cooling and heating)
- Two separate schedules
- Summer time setting
- Built-in room temperature sensors
- Hybrid control (boiler interlock)
- Floor drying mode
- Weekly timer
- Holiday mode
- Legionella prevention
- Error codes

#### Wireless remote controller (optional)

- Built-in room temperature sensor; easy to place in the best position to detect room temperature
- Wiring work eliminated
- Simple design that is easy to operate
- Remote control from any room without needing to choose an installation location
- Backlight and big buttons that are easy to operate
- Domestic hot water boost and cancellation
- Simplified holiday mode



## Energy Monitoring

### View Electricity Consumption and Heat Output on the Remote Controller

Every end user can now easily check the energy data of the ecodan heat pump.

#### Other features

- Daily, monthly and yearly data are stored and can be displayed using the main remote controller.
- External power meter and heat meter can be connected for accurate measurement.
- SD card is also available for storing data.

\*Using pre-set values on the main remote controller, estimated energy consumption/output can be shown without external power and a heat meter.

Depending on operating condition and system configuration, there is some possibility to show different data from the reality.

\*This function is available depending on the version of the outdoor unit model.



## Summer Time Setting

### Easy Adjustment for Summer Time

Just switch the summer time mode 'on' using the main remote controller and the clock in the main remote controller is adjusted to summer time hours.

This function can release the end user from clock setting tasks.



## Two Separate Schedules

### Pre-setting Two Different Schedules for Winter and Summer Seasons

Two different schedule settings are available for use via the main remote controller.

These schedules can be pre-set and changed depending on the season. For example, from November to March, space heating and domestic hot water are used; however, during warm months such as from April to October, only domestic hot water is used.

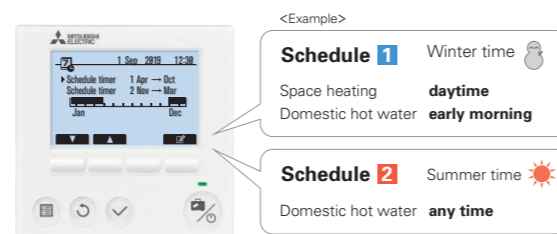

## Easy Commissioning

### Pump for Primary Water Circuit\* Speed Setting Possible Using ecodan's Main Remote Controller

Even when the system is running, pump output can be set to one of five different settings using the main remote controller.

The person commissioning the system can adjust this speed much more easily.

\*Speed setting of pump for domestic hot water is not available through the main remote controller when the system is running.

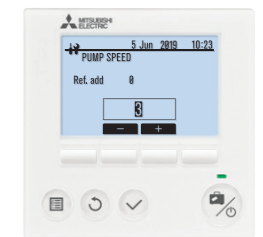

#### Flow sensor newly incorporated

The flow sensor is key for monitoring energy output and can also be used to detect flow error as well.

- Flow rate can be checked on the main remote controller.
- Flow rate can also be shown as graphs using the SD card tool.

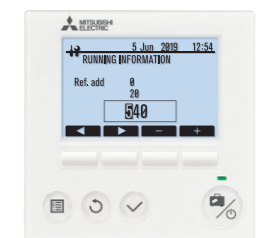

#### Run indoor unit\* without outdoor unit

During installation or situations such as an outdoor unit malfunction, the indoor unit can be operated using a heater.

While using this mode, flow and tank temperature are selectable.

Fixing and maintenance of the outdoor unit can be done without stopping heating and domestic hot water operation\*.

\*Models with electric heater only.

\*When the indoor unit operation stops, please check all settings after the outdoor unit is connected.



## SD\* Card

### For Easier Settings and Data Logging

The initial setting for ecodan is now simpler than ever before. The special software enables the required initial settings to be saved to an SD card using a personal computer. The system set-up is as easy as moving the SD card from the computer to the SD card slot in the indoor unit. Compared to the previous procedure of inputting settings using the main controller at the installation site, a remarkable reduction in set-up time has been achieved. Thus, it is ideal for busy installers.

\*SD card function is only used at the time of installation.

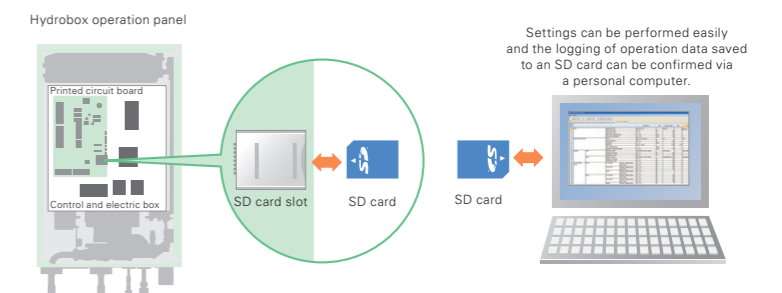

#### Items that can be pre-set

Simply copying pre-set data to an SD card, the same settings can be input into another unit using the SD card.

- Initial settings (time display, contact number, etc.)
- Heating settings
  - Auto adaptation
  - Heat curve
  - Two different temperature zones (heating and cooling)
- Interlocked boiler operation settings
- Holiday mode settings
- Schedule timer settings (two separate schedules)
- Domestic hot water settings
- Legionella prevention settings

All items that are set by the main controller can be set via a personal computer.

#### Data that can be stored

Operation data up to a month long can be stored on a single SD card

- Consumed electrical energy
- Delivered energy
- Flow rate
- Operation time
- Defrost time
- Actual temperature
  - Room temperature
  - Flow temperature
  - Return temperature
  - Domestic hot water temperature
  - Outdoor temperature
- Error record
- Input signal
- Etc.



# 2 Zone Cylinder

## Excellent Performance with Mitsubishi Electric First 2 zone cylinder

2 zone cylinder control 1/2 zones water temperature. Also, magnetic filter and mud trap are newly added instead of strainer. Thanks to built-in magnetic filter and mud trap, installer work/time can be reduced.

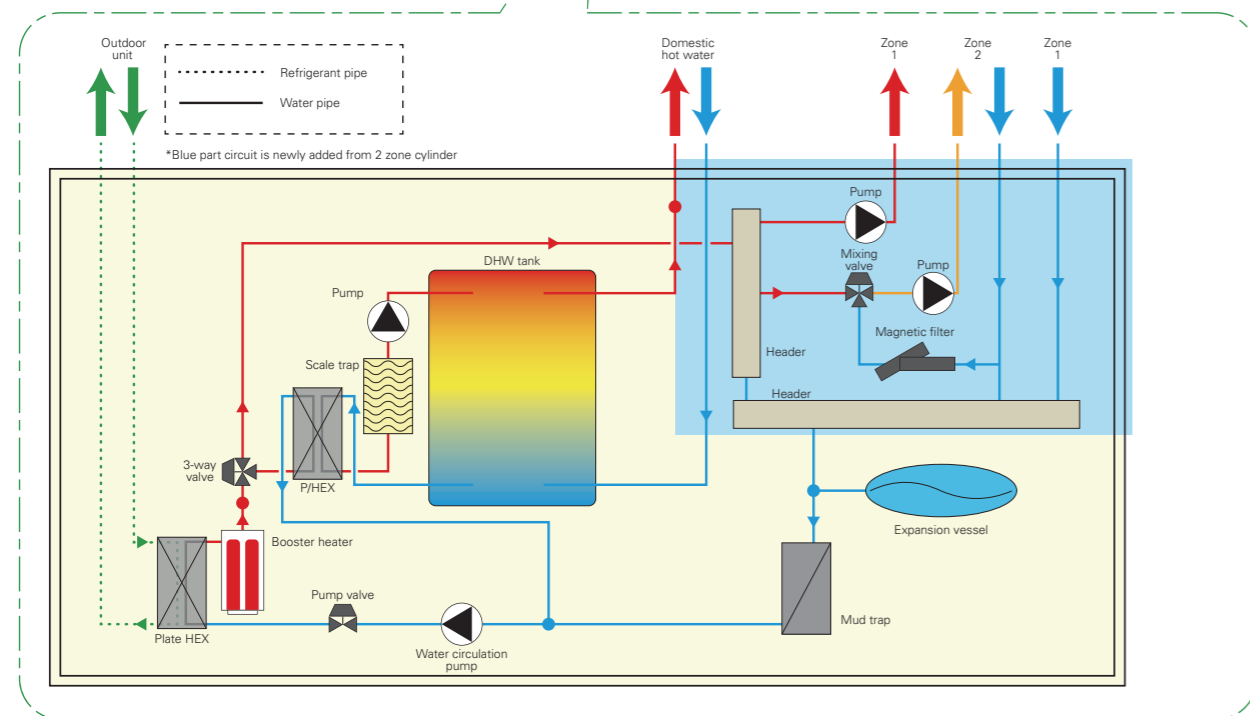
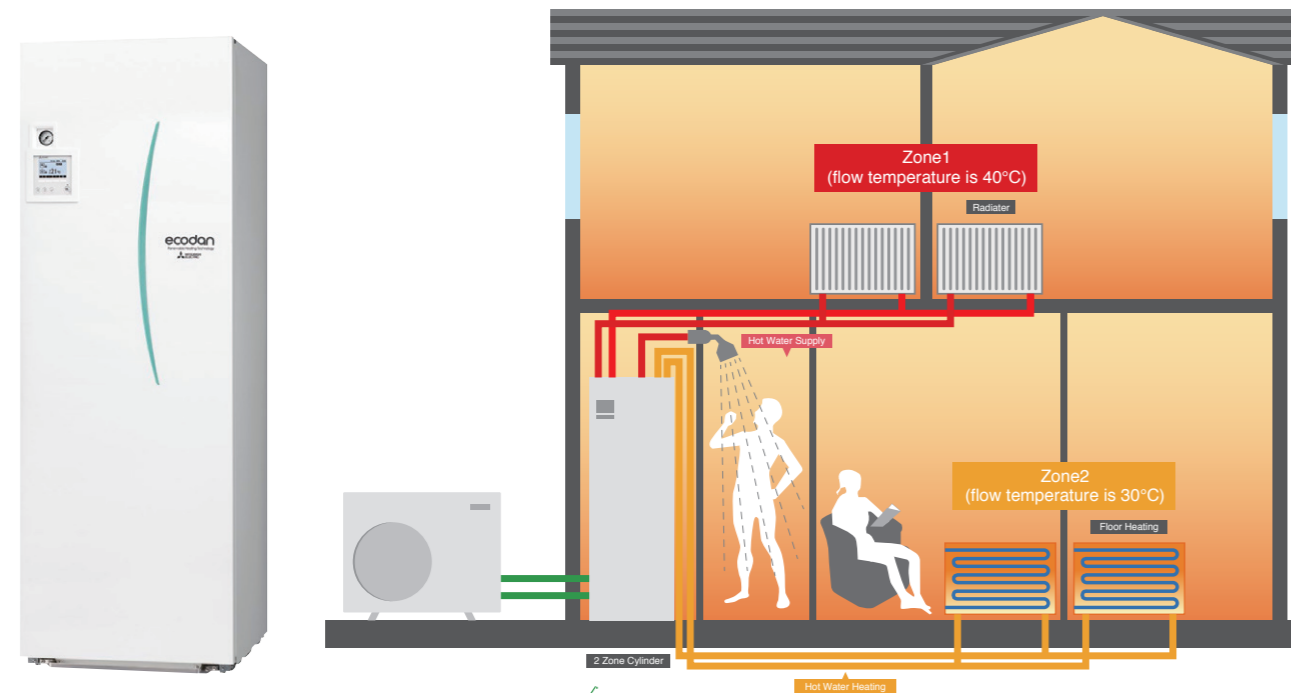

## Components

The figure below is component of 2 zone cylinder. Magnetic filter/mud trap are newly added.

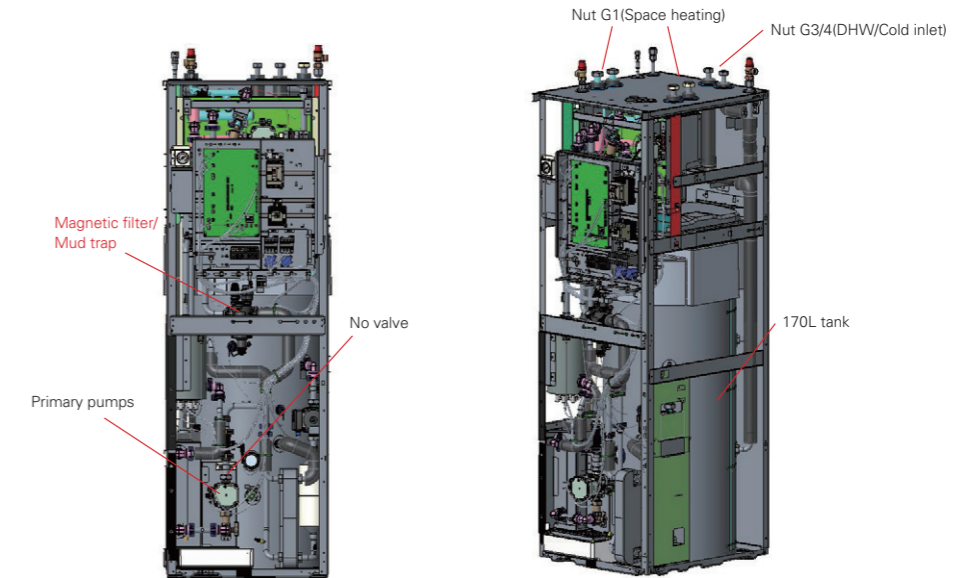

## Clean circuit water

Magnetic filter and mud trap are newly added instead of strainer. Thanks to them, keep the water in the circuit clean and prevent deterioration of mixing valve.

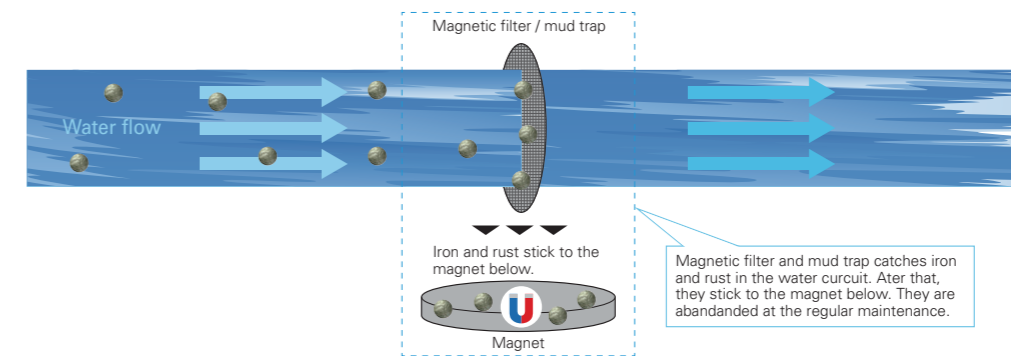

## Easy installation & transportation

At only 1750mm, 2 zone cylinder is the class-leading compact unit on the market, making the ideal solution for rooms and basements with a low ceiling height.

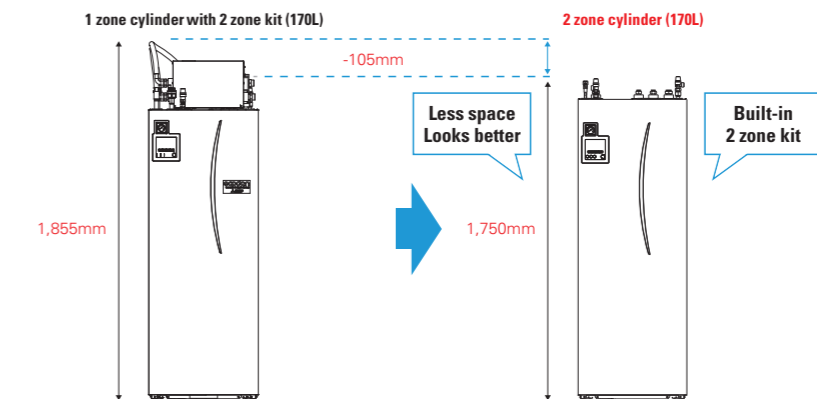

Dimension (H\*W\*D) 1,855\*595\*680

1,750\*595\*680



# ecodan geodan

## Excellent Performance with Mitsubishi Electric First Residential Ground Source Heat Pump

Ground source heat pump works best especially in replacement from old ground source heat pump.

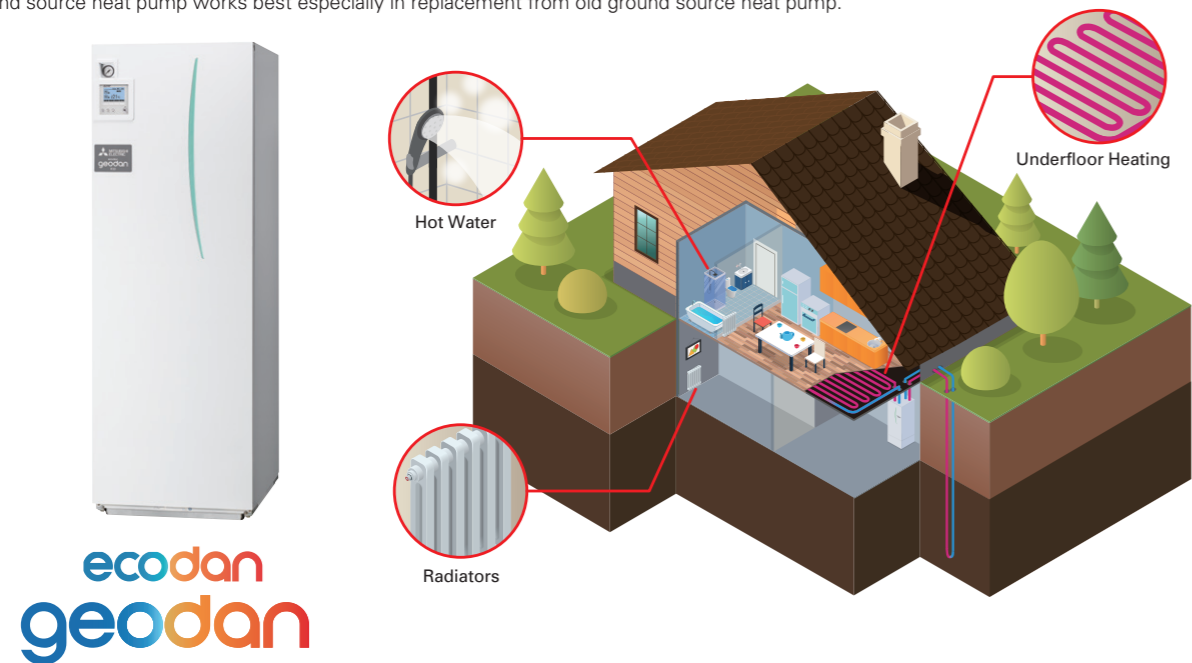

## Performance / Function

### High Performance

ErP Lot 1 Compliant with highest seasonal space heating energy efficiency class A+++.



TIME FOR R32

Low GWP refrigerant R32 contributes the reduction of CO<sub>2</sub> emission compared with conventional R410A refrigerant.

### A+++ Class Energy Efficiency

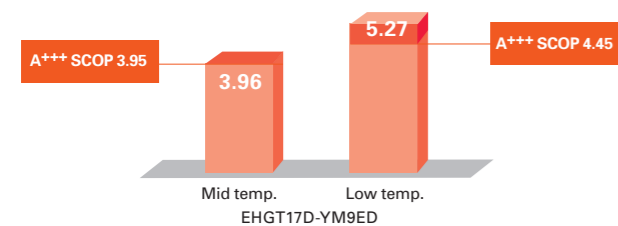

### <ATW vs GSHP> CO<sub>2</sub> equivalent emission

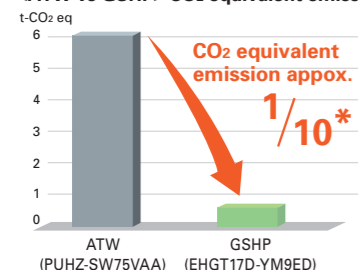

Model name	PUHZ-SW75VAA	EHG17D-YM9ED
Refrigerant amount	3.0kg	0.9kg
GWP	2088 (R410A)	675 (R32)
t-CO <sub>2</sub> eq	6.264	0.608

\*Source: IPCC 4th Assessment Report, global warming potential (GWP) 100-year value. Comparison of 2088(R410A) and 675 (R32).

### New Compressor Frequency Control

By reducing frequency changes (from 17 to 4 times per hour), hunting is prevented. Reducing fluctuation improves efficiency and prolongs compressor life.

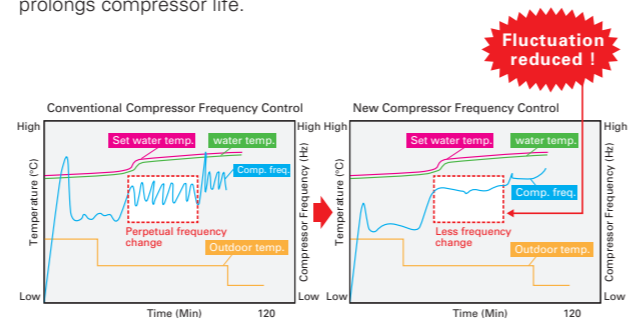

### Borehole Protection Control

When the unit detects low underground temperature, it automatically reduces the capacity by decreasing heat source collection in order to protect the borehole.

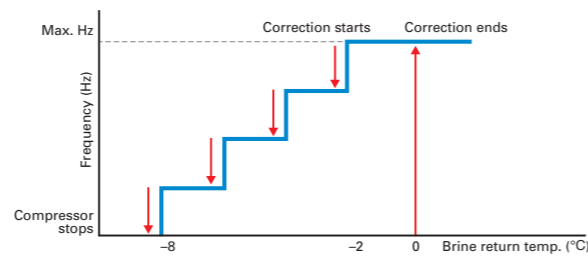

When the brine return temperature is below -8°C and brine outlet temperature is below -12°C, the unit operates only by booster heater. The correction temperature can be changed by dip SW.

## Comfort with Silence

Mitsubishi Electric heat pumps are designed to give you highly efficient and eco-friendly heating with the lowest possible noise level. ecodan geodan achieved industry-leading low noise, 42dB(A)\*.

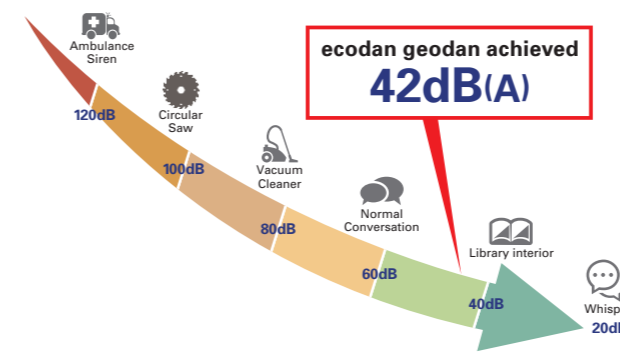

## Silencing Noise

The triple covering structure of the compressor unit greatly reduces sound level through noise absorption.

**1st Cover**  
Compressor sound insulation box (with noise absorbing felt and damper)

**2nd Cover**  
Module Box (with noise absorbing felt)

**3rd Cover**  
Outside panel (with noise absorbing felt)

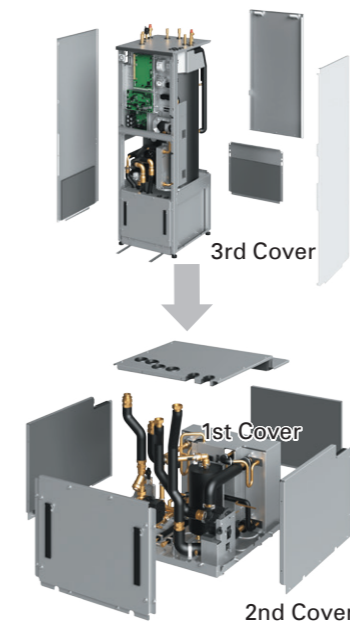

## Avoiding Vibration Noise

Rubber mounted stabilizer plate cushions the vibration noise of the compressor



## Easy Installation & Transportation

At only 1750mm, ecodan geodan is the class-leading compact unit on the market, making it the ideal solution for rooms and basements with a low ceiling height.

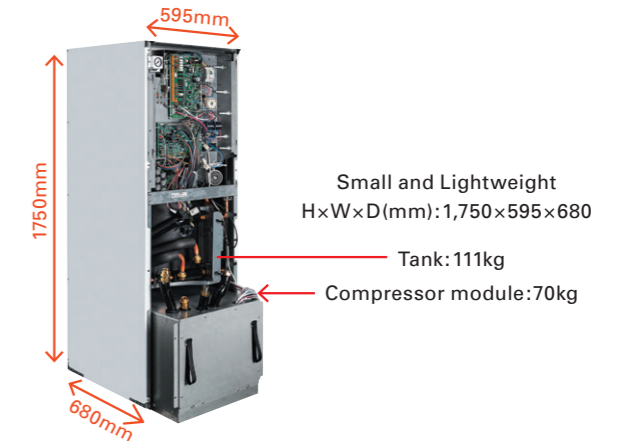

## Easy Transportation

Compressor module can be removed for easier installation and transportation. Once removed, the tank can be transported horizontally.



## Flexible Piping Work

Pipings on top are placed in a Zig-Zag shape. This enables easier installation without interrupting each piping work, especially in case of replacement.



## Easy Adjustment

Adjust bolt capable of 50mm expansion for easy installation even on uneven surfaces.

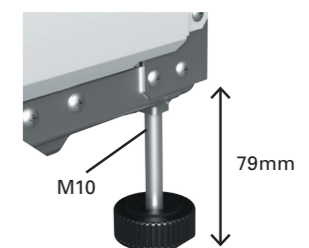



# Mr.SLIM+

## A Smart Air Conditioning and Hot Water Supply System Conceived from Eco-conscious Ideas

Mr. SLIM+ has a heat recovery function, which uses waste heat from air conditioners to heat water. Thanks to heat recovery, the Mr. SLIM+ model can achieve a COP of 7.0\*, resulting in intelligent systems with amazing efficiency.

\*Conditions for air-to-air cooling: Indoor 27°C (dry bulb), 19°C (wet bulb); Outdoor 35°C (dry bulb)

## 1 Unit, 2 Roles – Total Comfort Year-round

### Air Conditioning and Hot Water Supply Matching the Needs of Each Room

#### All-in-one outdoor unit (air conditioning, domestic hot water supply and hot water heating)

##### Mr. SLIM for Air-to-Air

Mr. SLIM+ utilises a duct system that enables the air conditioning or heating of multiple rooms, and other indoor unit type systems that it is possible to fit to various applications.

##### ecodan for Air-to-Water

- ✓ Domestic hot water (DHW) supply
- ✓ Heating for multiple rooms

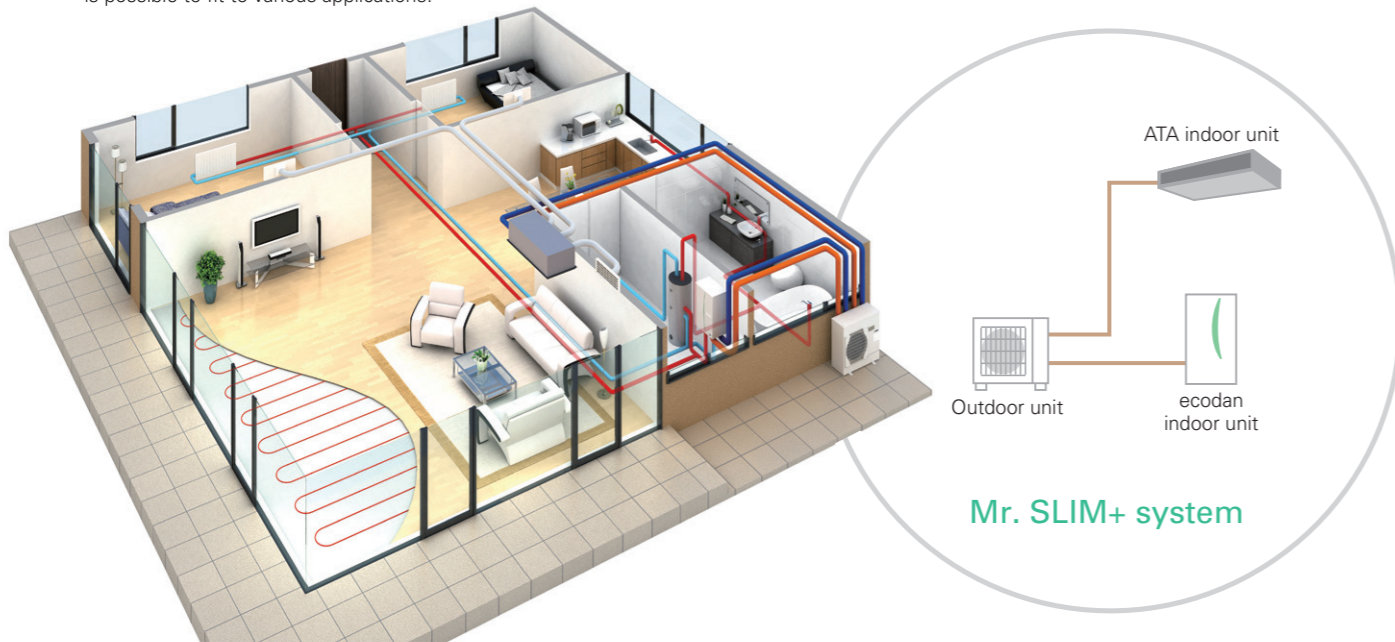

Mr. SLIM+ system

## Various Operations

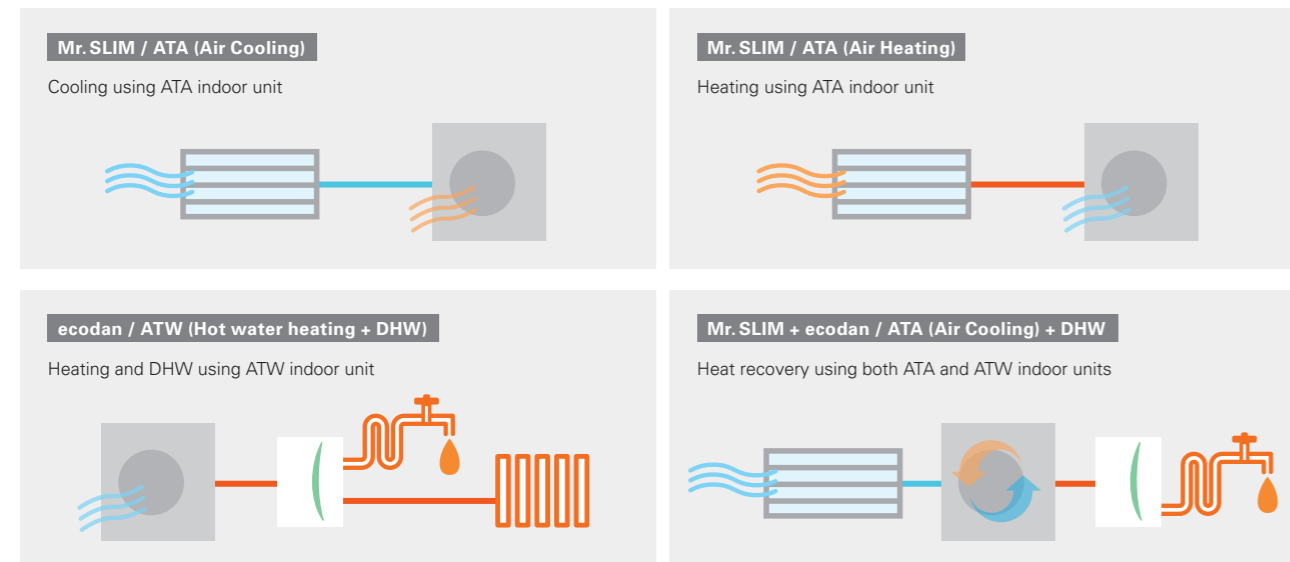

## Specifications

Indoor unit		PLA-ZM71EA2	PKA-M71KA(L)2	PCA-M71KA2	PSA-M71KA	PEAD-M71JA2	PEAD-M71JAL2				
Outdoor unit		PUHZ-FRP71VHA2	PUHZ-FRP71VHA2	PUHZ-FRP71VHA2	PUHZ-FRP71VHA2	PUHZ-FRP71VHA2	PUHZ-FRP71VHA2				
Refrigerant		R410A*1									
Power supply		230 / Single / 50									
Air-to-Air (ATA)	Cooling	Capacity	Rated	kW	7.1	7.1	7.1	7.1	7.1	7.1	
		Min-Max	kW	3.3-8.1	3.3-8.1	3.3-8.1	3.3-8.1	3.3-8.1	3.3-8.1	3.3-8.1	
	Total input	Rated	kW	1.88	1.93	1.93	2.15	2.15	2.09	2.09	
		EER		3.77	3.67	3.67	3.30	3.3	3.4	3.4	
	Design load		kW	7.1	7.1	7.1	7.1	7.1	7.1	7.1	
		Annual electricity consumption *2	kWh/a	376	386	384	409	446	423	423	
	SEER *4			6.6	6.4	6.4	6.0	5.5	5.8	5.8	
		Energy-efficiency class		A++	A++	A++	A+	A	A+	A+	
	Heating (average season)	Capacity	Rated	kW	8.0	8.0	8.0	8.0	8.0	8.0	8.0
			Min-Max	kW	3.5-10.2	3.5-10.2	3.5-10.2	3.5-10.2	3.5-10.2	3.5-10.2	3.5-10.2
Total input		Rated	kW	2.11	2.29	2.29	2.42	2.14	2.14	2.14	
		COP		3.80	3.50	3.50	3.30	3.74	3.74	3.74	
Design load			kW	4.7	4.7	4.7	4.7	4.9	4.9	4.9	
		Declared capacity	at reference design temperature	kW	4.7 (-10°C)	4.7 (-10°C)	4.7 (-10°C)	4.7 (-10°C)	4.9 (-10°C)	4.9 (-10°C)	4.9 (-10°C)
at bivalent temperature			kW	4.7 (-10°C)	4.7 (-10°C)	4.7 (-10°C)	4.7 (-10°C)	4.9 (-10°C)	4.9 (-10°C)	4.9 (-10°C)	
at operation limit temperature			kW	3.5 (-20°C)	3.5 (-20°C)	3.5 (-20°C)	3.5 (-20°C)	3.7 (-20°C)	3.7 (-20°C)	3.7 (-20°C)	
Back-up heating capacity			kW	0	0	0	0	0	0	0	
		Annual electricity consumption *2	kWh/a	1,509	1,564	1,556	1,699	1,741	1,741	1,741	
SCOP *4			4.3	4.2	4.2	3.8	3.9	3.9	3.9		
	Energy-efficiency class		A+	A+	A+	A	A	A	A		
Air-to-Water (ATW)	Nominal flow rate (for heating)		L/min	22.90							
		Heating *5	A7W35	Capacity	kW	8.00	8.00	8.00	8.00	8.00	8.00
	Input		kW	1.98	1.98	1.98	1.98	1.98	1.98	1.98	
			COP		4.05	4.05	4.05	4.05	4.05	4.05	
	A2W35	Capacity	kW	7.50	7.50	7.50	7.50	7.50	7.50		
		Input	kW	2.67	2.67	2.67	2.67	2.67	2.67		
			COP		2.81	2.81	2.81	2.81	2.81	2.81	
	Heat recovery (ATA cooling + ATW) *6	W45	Capacity (ATA cooling + ATW)	kW	7.1+8.0	7.1+8.0	7.1+8.0	7.1+8.0	7.1+8.0	7.1+8.0	
			Input	kW	1.90	1.93	1.95	2.02	2.20	2.18	
			COP		7.95	7.82	7.74	7.48	6.86	6.92	
W55		Capacity (ATA cooling + ATW)	kW	7.1+9.0	7.1+9.0	7.1+9.0	7.1+9.0	7.1+9.0	7.1+9.0		
		Input	kW	2.97	3.00	3.02	3.09	3.27	3.25		
		COP		5.42	5.37	5.33	5.21	4.92	4.95		
ATW indoor unit		Cylinder unit or Hydrobox (see previous page)									
Outdoor unit	Dimensions	HxWxD	mm	943-950-330 (+30)							
		Weight	kg	73	73	73	73	73	73		
	Air volume	Cooling	m <sup>3</sup> /min	50	50	50	50	50	50		
		Heating	m <sup>3</sup> /min	50	50	50	50	50	50		
	Sound pressure level (SPL)	Cooling	dB(A)	47	47	47	47	47	47		
		Heat recovery	dB(A)	47	47	47	47	47	47		
		ATA Heating	dB(A)	49	49	49	49	49	49		
		ATW Heating	dB(A)	49	49	49	49	49	49		
	Sound power level (PWL)	Cooling	dB(A)	67	67	67	67	67	67		
		Heat recovery	dB(A)	67	67	67	67	67	67		
ATA Heating		dB(A)	68	68	68	68	68	68			
ATW Heating		dB(A)	68	68	68	68	68	68			
Operating current (max)	A	19.0	19.0	19.0	19.0	19.0	19.0				
Breaker size	A	25	25	25	25	25	25				
Ext.piping	Diameter	Liquid/Gas	mm	9.52/15.88	9.52/15.88	9.52/15.88	9.52/15.88	9.52/15.88	9.52/15.88		
	Max. length	Out-In	m	30 (for ATA) + 30 (for ATW)							
		Out-In	m	20	20	20	20	20	20		
Guaranteed operating range (outdoor)	Cooling *3		°C	-15~+46	-15~+46	-15~+46	-15~+46	-15~+46	-15~+46		
		Heating	°C	-20~+21	-20~+21	-20~+21	-20~+21	-20~+21	-20~+21		
	ATW		°C	-20~+35	-20~+35	-20~+35	-20~+35	-20~+35	-20~+35		
		Heat recovery	°C	+7~+46	+7~+46	+7~+46	+7~+46	+7~+46	+7~+46		

\*1 Refrigerant leakage contributes to climate change. Refrigerant with lower global warming potential (GWP) would contribute less to global warming than a refrigerant with higher GWP, if leaked to the atmosphere. This appliance contains a refrigerant fluid with a GWP equal to 1975. This means that if 1 kg of this refrigerant fluid would be leaked to the atmosphere, the impact on global warming would be 1975 times higher than 1 kg of CO<sub>2</sub>, over a period of 100 years. Never try to interfere with the refrigerant circuit yourself or disassemble the product yourself and always ask a professional. The GWP of R410A is 2088 in the IPCC 4th Assessment Report.

\*2 Energy consumption based on standard test results. Actual energy consumption will depend on how the appliance is used and where it is located.

\*3 Optional air protection guide is required where ambient temperature is lower than -5°C.

\*4 SEER/SCOP values are measured based on EN14825.

\*5 Air-to-Water values are measured based on EN14511 (Circulation pump input is not included.).

\*6 Conditions for Air-to-Air cooling: Indoor 27°C (dry bulb) /19°C (wet bulb); Outdoor 35°C (dry bulb).



# PUMY+ecodan

Air-to-Air and Air-to-Water Hybrid Multi Split System

1 Unit, 2 Roles – Total Comfort Year-round

Air Conditioning and Hot Water Supply Matching the Needs of Each Room

All-in-one outdoor unit (air conditioning, domestic hot water supply and hot water heating)

## PUMY for Air-to-Air

PUMY utilises various indoor units, enabling the air conditioning or heating of multiple rooms, and controls each unit individually.

## ecodan for Air-to-Water

✓Domestic hot water (DHW) supply  
✓Heating for multiple rooms

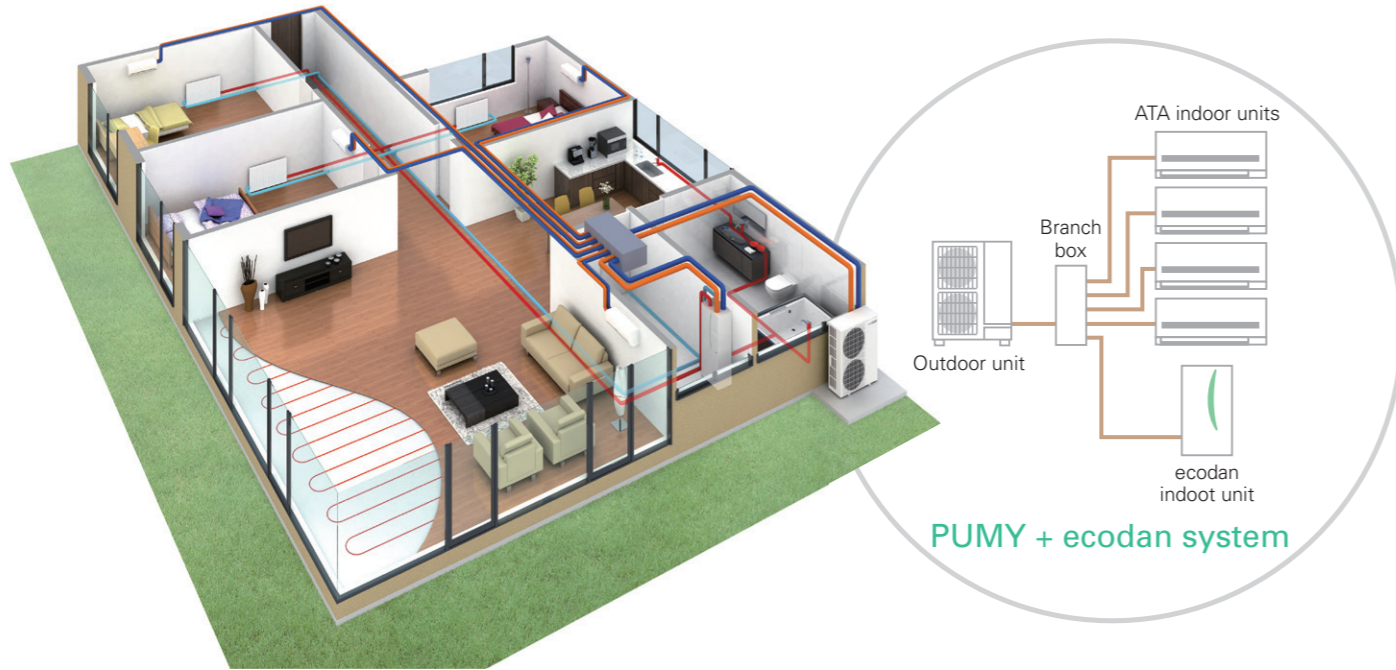

## Main Operation Patterns

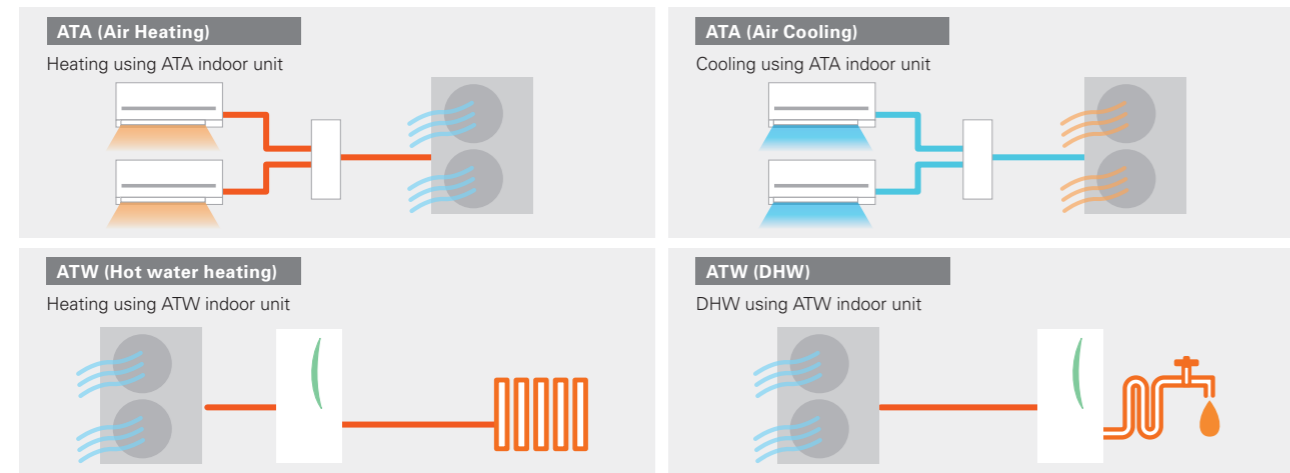

## Optional Operation Patterns\* (simultaneous)

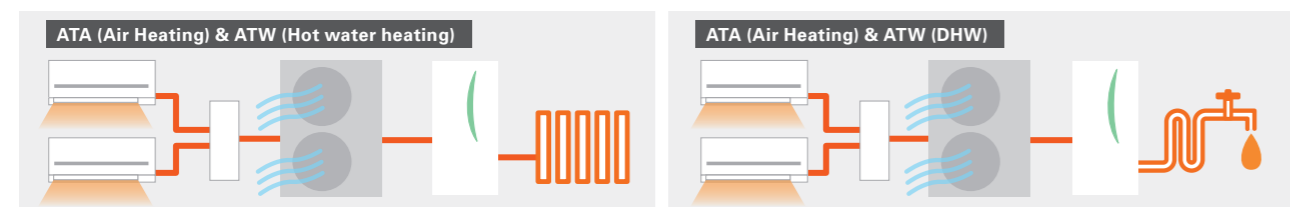

\*When using optional simultaneous operation, there are some restrictions, such as connectable indoor units, operation range and DHW flow temp.

## Usage Pattern All-in-one System Solution

### Summer 2-in-1 Operation

In summer ATA cooling and DHW are utilised. Keep your room comfortable with ATA cooling during high temperature daytime. Heat pump operates to heat up water stored in the DHW tank when ATA is not operated. The hot water can be utilised for shower and washing dishes during daytime.

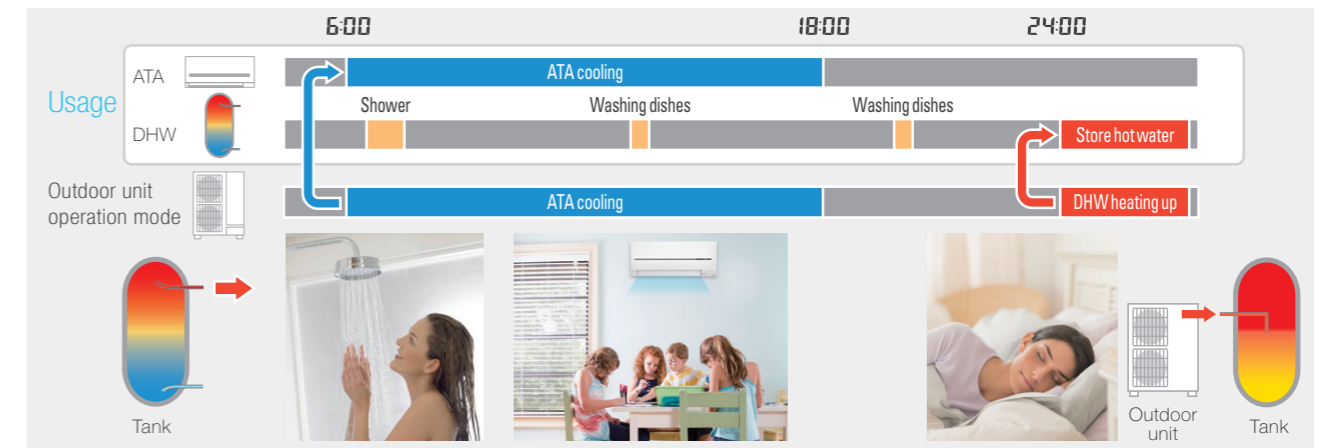

### Spring & Autumn 2-in-1 Operation

In spring and autumn, ATA heating and DHW are utilised. ATA heating can warm up each room quickly during the low temperature morning and evening. Heat pump operates to heat up water stored in the DHW tank when ATA is not operated. The hot water can be utilised for shower and washing dishes during daytime.

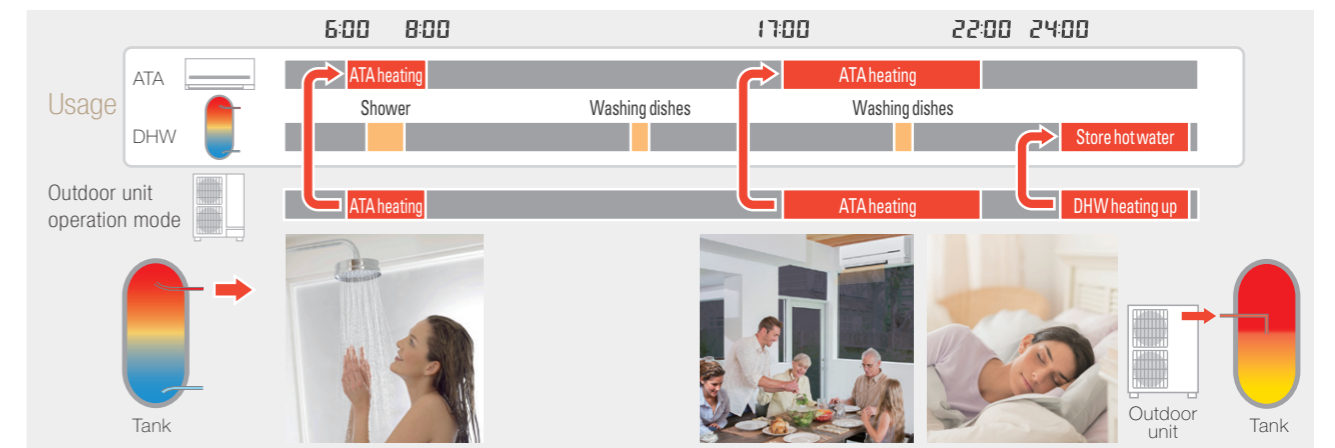

### Winter ecodan

In winter ATW heating and DHW are utilised. ATW heating warms home all the day in severe cold weather. ATW heating stops temporarily only when the heat pump operates to heat up water stored in the DHW tank.

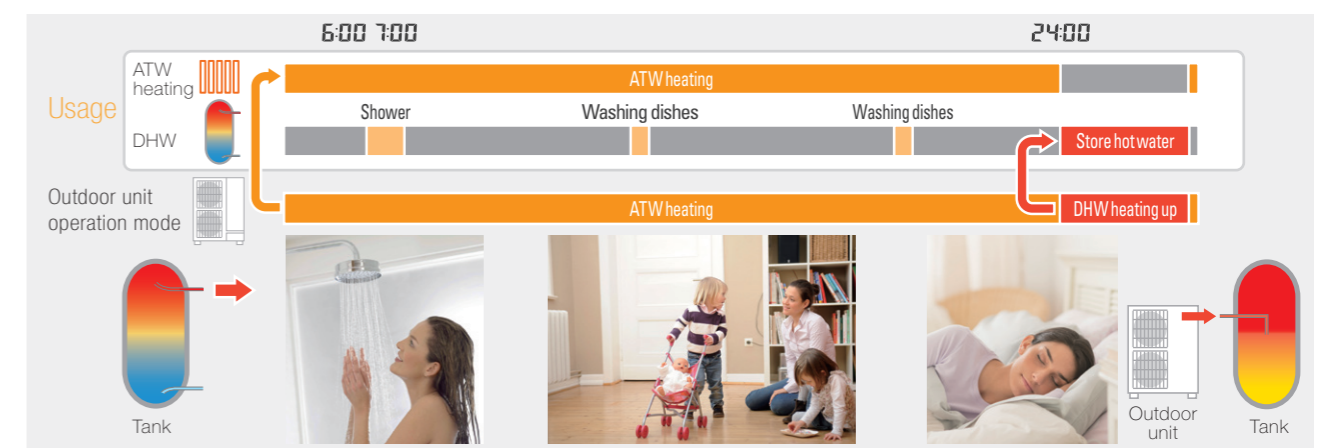



Model name		PUMY-P112VKM5(-BS)	PUMY-P125VKM5(-BS)	PUMY-P140VKM5(-BS)	PUMY-P112YKME(-BS)	PUMY-P125YKME(-BS)	PUMY-P140YKME(-BS)			
Power supply		1-phase 220 - 230 - 240V, 50Hz			3-phase 380 - 400 - 415V, 50Hz					
Air-to-Air (ATA)	Cooling (nominal)*1	Capacity	kW	12.5	14.0	15.5	12.5	14.0	15.5	
		Power input	kW	2.79	3.46	4.52	2.79	3.46	4.52	
		EER		4.48	4.05	3.43	4.48	4.05	3.43	
	Temp. range of cooling	Indoor temp.	W.B.	15 - 24°C						
		Outdoor temp.*2	D.B.	-5 - 52°C						
	Heating (nominal)*1	Capacity	kW	14.0	16.0	18.0	14.0	16.0	18.0	
Power input		kW	3.04	3.74	4.47	3.04	3.74	4.47		
COP			4.61	4.28	4.03	4.61	4.28	4.03		
Temp. range of heating	Indoor temp.	W.B.	15 - 27°C							
	Outdoor temp.	D.B.	-20 - 15°C							
Air-to-Water (ATW)	Nominal flow rate (for heating)	Capacity	L/min	35.8						
		Capacity	kW	12.5						
		Power input	kW	3.06						
	Heating*3	A7W35	COP		4.08					
			Capacity	kW	10.0					
			Power input	kW	3.50					
	Guaranteed operating range	ATA	Heating	D.B.	-20 - +21°C					
			DHW	D.B.	-20 - +35°C					
			ATA heating + DHW	D.B.	7 - +21°C					
	Maximum Outlet water temp.	ATA heating + ATW heating *4	D.B.		-10 - +21°C					
°C				55						
°C				55						
Outdoor unit	Indoor unit connectable	ATA only	Total capacity	50 to 130% of outdoor unit capacity						
			Model/Quantity	Branch box system	15-100/8	15-100/8	15-100/8	15-100/8	15-100/8	15-100/8
		ATA + ATW individual operation	Total capacity	ATA: Max 130% of outdoor unit capacity + ATW (EHST20C or EHSC) *7						
			Model/Quantity	Branch box system	15-100/8	15-100/8	15-100/8	15-100/8	15-100/8	15-100/8
		ATA + ATW simultaneous operation	Total capacity	Max 100% of outdoor unit capacity: ATA + ATW (EHST20C or EHSC) *7						
			Model/Quantity	ATA*12	15/1*8	15-25/2*9	15-42*11/3*10	15/1*8	15-25/2*9	15-42*11/3*10
	Sound pressure level (measured in anechoic room)	dB<A>	49 / 51	50 / 52	51 / 53	49 / 51	50 / 52	51 / 53		
			69 / 71	70 / 72	71 / 73	69 / 71	70 / 72	71 / 73		
	Refrigerant piping diameter	Liquid pipe	mm	9.52 flare						
		Gas pipe	mm	15.88 flare						
	Fan	Type x Quantity		Propeller fan x 2						
		Airflow rate	m³/min	110						
L/s			1,883							
cfm			3,884							
Compressor	Motor output	kW	0.074 + 0.074							
	Type x Quantity		Scroll hermetic compressor x 1							
External dimensions (H x W x D)	mm	1,338 x 1,050 x 330 (+40)								
		Inverter								
Weight	kg	122			YKM: 125 / YKME: 136					

	Indoor	Outdoor	Piping length	Level difference
Cooling	27°C DB / 19°C WB	35°C DB	7.5m	0m
Heating	20°C DB	7°C DB / 6°C WB	7.5m	0m

- \*1 10 to 52°C D.B.: When connecting PKFY-P15/20/25VBM, PFFY-P20/25/32VKM, PFFY-P20/25/32VLE(R)M, PEFY-P+VMA3 or M, S and P series indoor unit.
- \*2 In the case of ATW single connection. Input to circulation pump is not included.
- \*3 In the case of simultaneous operation of ATA heating and ATW heating, target flow temperature range is restricted to 45-55°C and when the ambient temp is under 7°C, the flow temp is lowered.
- \*4 Up to P100 when connecting via branch box.
- \*5 Up to 11 units when connecting via 2 branch boxes.
- \*6 Only one ecodan unit can be connected.
- \*7 Exceptionally, one MSZ-SF15VA or MSZ-AP15VF can be connected.
- \*8 Exceptionally, two MSZ-SF15VA or MSZ-AP15VF can be connected.
- \*9 Exceptionally, three MSZ-SF15VA or MSZ-AP15VF can be connected.
- \*10 In the case of City Multi connection, maximum is P32.
- \*11 PKFY and PFFY series are not connectable.

Piping specifications

Total piping length	m	150*	a+b+c+d+e+f
Farthest piping length	m	80	a+b+d or a+c+e
		85	a+f
Total piping length between outdoor unit and branch box	m	55	a+b+c
Total piping length between branch boxes and indoor units	m	95	d+e
Farthest piping length from the first joint	m	30	b or c or f
Farthest piping length after branch box	m	25	d or e
Height difference (Outdoor upside / Outdoor downside)	m	50 / 40	

\*When an ecodan is connected, the maximum piping length is 150m.

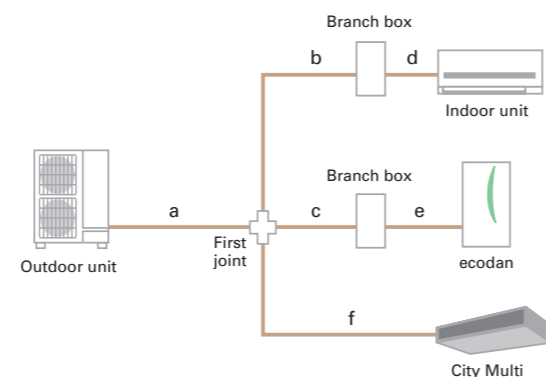

ATW branch box connection compatibility table

Series	Type	Model name	Compatibility	Type	Model name	Compatibility	Type	Model name	Compatibility
ATW	Cylinder unit	EHST20C-VM2/6D	●	Hydrobox	EHSC-VM2/6D	●	Branch box	PAC-MK53BC	●
		EHST20C-YM9D	●		EHSC-YM9D	●		PAC-MK33BC	●
		EHST20C-TM9D	●		EHSC-TM9D	●		PAC-MK53BCB	●
		EHST20C-YM9ED	●		EHSC-YM9ED	●		PAC-MK33BCB	●

Connectable indoor unit capacity

For individual operation ATA+ATW (no simultaneous operation) ATA: Max 130% of outdoor unit capacity + ATW (EHST20C or EHSC)

Outdoor capacity 12.5kW	ATW indoor unit (Cylinder or Hydrobox) 11.2kW	Connectable ATA indoor unit total capacity: Max.16.2kW (130%)
Outdoor capacity 14.0kW	ATW indoor unit (Cylinder or Hydrobox) 11.2kW	Connectable ATA indoor unit total capacity: Max.18.2kW (130%)
Outdoor capacity 15.5kW	ATW indoor unit (Cylinder or Hydrobox) 11.2kW	Connectable ATA indoor unit total capacity: Max.20.2kW (130%)

For simultaneous operation of ATA+ATW Max 100% of outdoor unit capacity: ATA + ATW (EHST20C or EHSC)

Outdoor capacity 12.5kW	ATW indoor unit (Cylinder or Hydrobox) 11.2kW	ATA capacity Max. 1.3kW	*Exceptionally, one MSZ-SF15VA or MSZ-AP15VF can be connected.
Outdoor capacity 14.0kW	ATW indoor unit (Cylinder or Hydrobox) 11.2kW	ATA capacity Max. 2.8kW	*Exceptionally, two units of MSZ-SF15VA or MSZ-AP15VF can be connected.
Outdoor capacity 15.5kW	ATW indoor unit (Cylinder or Hydrobox) 11.2kW	ATA capacity Max. 4.3kW	*Exceptionally, three units of MSZ-SF15VA or MSZ-AP15VF can be connected.



# Split Type Specifications

## Indoor unit

### <Cylinder unit (Heating only)>

Model name		Small capacity															
		EHST17D-VM2D	EHST17D-VM9D	EHST20D-MED	EHST20D-VM2D	EHST20D-VM6D	EHST20D-VM9D	EHST20D-VM9ED	EHST20D-TM9D	EHST30D-MED	EHST30D-VM6ED	EHST30D-VM9ED	EHST30D-TM9ED				
Type		Heating only															
Expansion vessel		✓	✓	—	✓	✓	✓	—	✓	—	—	—	—				
Booster heater (2/6/9kW)		✓	✓	—	✓	✓	✓	—	✓	—	—	—	—				
Dimensions	HxWxD	mm	1400x595x680	1600x595x680						2050x595x680							
Weight (empty)		kg	93	96	93	99	100	102	96	102	113	115	117				
Control Board Power supply (Phase / V / Hz)			~ /N, 230V, 50Hz	~ /N, 230V, 50Hz	~ /N, 230V, 50Hz	~ /N, 230V, 50Hz	~ /N, 230V, 50Hz	~ /N, 230V, 50Hz	~ /N, 230V, 50Hz	~ /N, 230V, 50Hz	~ /N, 230V, 50Hz	~ /N, 230V, 50Hz	~ /N, 230V, 50Hz				
Heater	Booster heater	Power supply (Phase / V / Hz)	~ /N, 230V, 50Hz	3 ~ 400V, 50Hz	~ /N, 230V, 50Hz	~ /N, 230V, 50Hz	3 ~ 400V, 50Hz	3 ~ 400V, 50Hz	3 ~ 400V, 50Hz	3 ~ 400V, 50Hz	~ /N, 230V, 50Hz	~ /N, 230V, 50Hz	3 ~ 400V, 50Hz				
		Capacity	kW	2	3+6	—	2	2+4	3+6	3+6	3+6	—	2+4	3+6			
		Current	A	9	13	—	9	26	13	13	23	—	26	13			
		Breaker size	A	16	16	—	16	32	16	16	32	—	32	16			
Domestic hot water tank	Volume / Material	L / -	170 / Stainless steel (Net)	200 / Stainless steel (Net)						300 / Stainless steel (Net)							
	Guaranteed operating range *1	Ambient	°C	0 - 35 (≤80%RH)													
Target temperature range	Heating	Room temperature	°C	10 - 30													
		Flow temperature	°C	20 - 60													
Target temperature range	Cooling	Room temperature	°C	—													
		Flow temperature	°C	—													
DHW tank performance	Max. hot water temperature	°C	70	70	*2	70						*2	70				
	Water heater energy efficiency class		A+														
Sound power level (PWL)		dB (A)	41														

\*1 The indoor environment must be frost-free.  
 \*2 For the model without booster heater and immersion heater, the maximum allowable hot water temperature is 3°C lower than maximum outlet water of outdoor unit.  
 For the maximum outlet water of outdoor unit, refer to outdoor unit data book.

### <Cylinder unit (Heating only)>

Model name		Medium capacity												
		EHST20C-MED	EHST20C-VM2D	EHST20C-VM6D	EHST20C-VM9D	EHST20C-VM9ED	EHST20C-TM9D	EHST30C-MED	EHST30C-VM6ED	EHST30C-VM9ED	EHST30C-TM9ED			
Type		Heating only												
Expansion vessel		—	✓	✓	✓	—	✓	—	—	—	—			
Booster heater (2/6/9kW)		—	✓	✓	✓	✓	—	✓	—	—	—			
Dimensions	HxWxD	mm	1600x595x680					2050x595x680						
Weight (empty)		kg	103	110	110	112	107	112	120	122	124	124		
Control Board Power supply (Phase / V / Hz)			~ /N, 230V, 50Hz	~ /N, 230V, 50Hz	~ /N, 230V, 50Hz	~ /N, 230V, 50Hz	~ /N, 230V, 50Hz	~ /N, 230V, 50Hz	~ /N, 230V, 50Hz	~ /N, 230V, 50Hz	~ /N, 230V, 50Hz	~ /N, 230V, 50Hz		
Heater	Booster heater	Power supply (Phase / V / Hz)	—	~ /N, 230V, 50Hz	~ /N, 230V, 50Hz	3 ~ 400V, 50Hz	3 ~ 400V, 50Hz	3 ~ 400V, 50Hz	—	~ /N, 230V, 50Hz	3 ~ 400V, 50Hz	3 ~ 400V, 50Hz		
		Capacity	kW	—	2	2+4	3+6	3+6	3+6	—	2+4	3+6	3+6	
		Current	A	—	9	26	13	13	23	—	26	13	23	
		Breaker size	A	—	16	32	16	16	32	—	32	16	32	
Domestic hot water tank	Volume / Material	L / -	200 / Stainless steel (Net)					300 / Stainless steel (Net)						
	Guaranteed operating range *1	Ambient	°C	0 - 35 (≤80%RH)										
Target temperature range	Heating	Room temperature	°C	10 - 30										
		Flow temperature	°C	20 - 60										
Target temperature range	Cooling	Room temperature	°C	—										
		Flow temperature	°C	—										
DHW tank performance	Max. hot water temperature	°C	*2	70						*2	70			
	Water heater energy efficiency class		A+											
Sound power level (PWL)		dB (A)	40											

\*1 The indoor environment must be frost-free.  
 \*2 For the model without booster heater and immersion heater, the maximum allowable hot water temperature is 3°C lower than maximum outlet water of outdoor unit.  
 For the maximum outlet water of outdoor unit, refer to outdoor unit data book.

### <Hydrobox (Heating only)>

Model name		Small capacity						Medium capacity						Large capacity			
		EHSD-MED	EHSD-VM2D	EHSD-VM6D	EHSD-VM9D	EHSD-VM9ED	EHSD-TM9D	EHSC-MED	EHSC-VM2D	EHSC-VM6D	EHSC-VM9D	EHSC-VM9ED	EHSC-TM9D	EHSE-MED	EHSE-VM9ED		
Type		Heating only															
Expansion vessel		—	✓	✓	✓	—	✓	—	✓	—	—	—	—	—			
Booster heater (2/6/9kW)		—	✓	✓	✓	✓	—	✓	—	—	—	—	—				
Dimensions	HxWxD	mm	800x530x360										950x600x360				
Weight (empty)		kg	36	43	44	44	40	44	40	47	48	48	48	61	63		
Control Board Power supply (Phase / V / Hz)			~ /N, 230V, 50Hz	~ /N, 230V, 50Hz	~ /N, 230V, 50Hz	~ /N, 230V, 50Hz	~ /N, 230V, 50Hz	~ /N, 230V, 50Hz	~ /N, 230V, 50Hz	~ /N, 230V, 50Hz	~ /N, 230V, 50Hz	~ /N, 230V, 50Hz	~ /N, 230V, 50Hz	~ /N, 230V, 50Hz	~ /N, 230V, 50Hz		
Heater	Booster heater	Power supply (Phase / V / Hz)	—	~ /N, 230V, 50Hz	~ /N, 230V, 50Hz	3 ~ 400V, 50Hz	3 ~ 400V, 50Hz	3 ~ 400V, 50Hz	—	~ /N, 230V, 50Hz	3 ~ 400V, 50Hz	3 ~ 400V, 50Hz	3 ~ 400V, 50Hz	—	3 ~ 400V, 50Hz		
		Capacity	kW	—	2	2+4	3+6	3+6	3+6	—	2	2+4	3+6	3+6	—	3+6	
		Current	A	—	9	26	13	13	23	—	9	26	13	13	23	—	
		Breaker size	A	—	16	32	16	16	32	—	16	32	16	16	32	—	
Guaranteed operating range *1	Ambient	L / -	0 - 35 (≤80%RH)														
		Outdoor	Heating	°C	See outdoor unit spec table												
Target temperature range	Heating	Room temperature	°C	10 - 30													
		Flow temperature	°C	20 - 60													
Target temperature range	Cooling	Room temperature	°C	—													
		Flow temperature	°C	—													
DHW tank performance	Max. hot water temperature	°C	70														
	Water heater energy efficiency class		A+														
Sound power level (PWL)		dB (A)	41						40						45		

\*1 The indoor environment must be frost-free.

# Split Type Specifications

## Indoor unit

### <Cylinder unit (Reversible)>

Model name		Small capacity													
		ERST17D-VM2D	ERST17D-VM2ED	ERST17D-VM6D	ERST17D-VM6ED	ERST17D-VM9D	ERST20D-VM2D	ERST20D-VM6D	ERST20D-VM9D	ERST30D-VM2D	ERST30D-VM6ED	ERST30D-VM9ED			
Type		Heating and Cooling													
Expansion vessel		✓	✓	✓	✓	✓	✓	✓	✓	✓	✓	✓	✓		
Booster heater (2/6/9kW)		✓	✓	✓	✓	✓	✓	✓	✓	✓	✓	✓	✓		
Dimensions	HxWxD	mm	1400x595x680	1750x595x680	1400x595x680	1750x595x680	1750x595x680	1600x595x680	1600x595x680	1600x595x680	2050x595x680	2050x595x680	12050x595x680		
Weight (empty)		kg	94	116	94	116	118	100	100	102	115	116	117		
Control Board Power supply (Phase / V / Hz)			~ /N, 230V, 50Hz	~ /N, 230V, 50Hz	~ /N, 230V, 50Hz	~ /N, 230V, 50Hz	~ /N, 230V, 50Hz	~ /N, 230V, 50Hz	~ /N, 230V, 50Hz	~ /N, 230V, 50Hz	~ /N, 230V, 50Hz	~ /N, 230V, 50Hz	~ /N, 230V, 50Hz		
Heater	Booster heater	Power supply (Phase / V / Hz)	~ /N, 230V, 50Hz	~ /N, 230V, 50Hz	~ /N, 230V, 50Hz	~ /N, 230V, 50Hz	~ /N, 230V, 50Hz	3 ~ 400V, 50Hz	~ /N, 230V, 50Hz	3 ~ 400V, 50Hz	~ /N, 230V, 50Hz	3 ~ 400V, 50Hz	~ /N, 230V, 50Hz		
		Capacity	kW	2	2	2+4	2	3+6	2	2+4	3+6	2	2+4	3+6	
		Current	A	9	9	26	9	13	9	26	13	9	26	13	
		Breaker size	A	16	16	32	16	16	16	32	16	16	32	16	
Domestic hot water tank	Volume / Material	L / -	170 / Stainless steel (Net)	170 / Stainless steel (Net)	170 / Stainless steel (Net)	170 / Stainless steel (Net)	170 / Stainless steel (Net)	200 / Stainless steel (Net)	200 / Stainless steel (Net)	200 / Stainless steel (Net)	300 / Stainless steel (Net)	300 / Stainless steel (Net)	300 / Stainless steel (Net)		
	Guaranteed operating range *1	Ambient	°C	0 - 35 (≤80%RH)											
Target temperature range	Heating	Room temperature	°C	10 - 30											
		Flow temperature	°C	20 - 60											
Target temperature range	Cooling	Room temperature	°C	—											
		Flow temperature	°C	—											
DHW tank performance	Max. hot water temperature	°C	70												
	Water heater energy efficiency class		A+												
Sound power level (PWL)		dB (A)	41												

\*1 The indoor environment must be frost-free.  
 \*2 During cooling operation at low outdoor temperature (10°C or lower), frozen water may cause damage on plate heat exchanger.

### <Cylinder unit (Reversible)>

Model name		Medium capacity							
		ERST20C-VM2D	ERST20C-VM6D	ERST20C-VM9D	ERST30C-VM2D	ERST30C-VM6ED	ERST30C-VM9ED		
Type		Heating and Cooling							
Expansion vessel		✓	✓	✓	✓	✓	✓		
Booster heater (2/6/9kW)		✓	✓	✓	✓	✓	✓		
Dimensions	HxWxD	mm	1600x595x680	1600x595x680	1600x595x680	2050x595x680	2050x595x680		
Weight (empty)		kg	110	111	112	122	124		
Control Board Power supply (Phase / V / Hz)			~ /N, 230V, 50Hz	~ /N, 230V, 50Hz	~ /N, 230V, 50Hz	~ /N, 230V, 50Hz	~ /N, 230V, 50Hz		
Heater	Booster heater	Power supply (Phase / V / Hz)	~ /N, 230V, 50Hz	~ /N, 230V, 50Hz	3 ~ 400V, 50Hz	~ /N, 230V, 50Hz	~ /N, 230V, 50Hz		
		Capacity	kW	2	2+4	3+6	2	2+4	
		Current	A	9	26	13	9	26	
		Breaker size	A	16	32	16	16	32	
Domestic hot water tank	Volume / Material	L / -	200 / Stainless steel (Net)	200 / Stainless steel (Net)	200 / Stainless steel (Net)	300 / Stainless steel (Net)	300 / Stainless steel (Net)		
	Guaranteed operating range *1	Ambient	°C	0 - 35 (≤80%RH)					
Target temperature range	Heating	Room temperature	°C	10 - 30					
		Flow temperature	°C	20 - 60					
Target temperature range	Cooling	Room temperature	°C	—					
		Flow temperature	°C	—					
DHW tank performance	Max. hot water temperature	°C	70						
	Water heater energy efficiency class		A						
Sound power level (PWL)		dB (A)	40						

\*1 The indoor environment must be frost-free.  
 \*2 During cooling operation at low outdoor temperature (10°C or lower), frozen water may cause damage on plate heat exchanger.

### <Hydrobox (Reversible)>

Model name		Small capacity				Medium capacity				Large capacity			
		ERSD-MED	ERSD-VM2D	ERSD-VM6D	ERSD-VM9D	ERSC-MED	ERSC-VM2D	ERSC-VM6D	ERSC-VM9D	ERSE-MED	ERSE-VM9ED		
Type		Heating and Cooling											
Expansion vessel		—	✓	✓	✓	—	✓	✓	✓	—	—		
Booster heater (2/6/9kW)		—	✓	✓	✓	—	✓	✓	✓	—	—		
Dimensions	HxWxD	mm	800x530x360								950x600x360		
Weight (empty)		kg	38	44	43	44	41	48	48	48	62	64	
Control Board Power supply (Phase / V / Hz)			~ /N, 230V, 50Hz	~ /N, 230V, 50Hz	~ /N, 230V, 50Hz	~ /N, 230V, 50Hz	~ /N, 230V, 50Hz	~ /N, 230V, 50Hz	~ /N, 230V, 50Hz	~ /N, 230V, 50Hz	~ /N, 230V, 50Hz	~ /N, 230V, 50Hz	
Heater	Booster heater	Power supply (Phase / V / Hz)	—	~ /N, 230V, 50Hz	~ /N, 230V, 50Hz	3 ~ 400V, 50Hz	—	~ /N, 230V, 50Hz	~ /N, 230V, 50Hz	3 ~ 400V, 50Hz	—	3 ~ 400V, 50Hz	
		Capacity	kW	—	2	2+4	3+6	—	2	2+4	3+6	—	3+6
		Current	A	—	9	26	13	—	9	26	13	—	13
		Breaker size	A	—	16	32	16	—	16	32	16	—	16
Guaranteed operating range *1	Ambient	°C	0 - 35 (≤80%RH)										
		Outdoor	Heating	°C	See outdoor unit spec table								
Target temperature range	Heating	Room temperature	°C	10 - 30									
		Flow temperature	°C	20 - 60									
Target temperature range	Cooling	Room temperature	°C	—									
		Flow temperature	°C	—									
DHW tank performance	Max. hot water temperature	°C	70										
	Water heater energy efficiency class		A+										
Sound power level (PWL)		dB (A)	41				40				45		

\*1 The indoor environment must be frost-free.  
 \*2 If you use our system in cooling mode at the low ambient temperature (10°C or below), there are some risks of plate heat exchanger breaking by frozen



# Split Type Specifications

## Outdoor unit

Model name		Eco Inverter				
Refrigerant		SUZ-SWM40VA	SUZ-SWM60VA	SUZ-SWM80VA		
Dimensions		R32*1				
HxWxD	mm	880x840x330	880x840x330	880x840x330		
Weight	kg	54	54	54		
Power supply (V / Phase / Hz)		230 / 1-ph / 50				
Heating	A7W35*2	Nominal	kW	4.0	6.0	7.5
		COP		5.20	4.86	4.70
	A2W35*2	Nominal	kW	4.0	5.0	6.5
		COP		3.90	3.33	3.40
Average climate water outlet 35°C*3		Class	A+++	A+++	A+++	
		ηs	180	181	182	
Average climate water outlet 55°C*3		Class	A++	A++	A++	
		ηs	129	130	131	
DHW 200(L)/300(L) Load Profile (Average climate)*4		Class	A+	A+	A+	
		ηwh	159	148	148	
Max outlet water temperature (°C)			60	60	60	
Cooling	A35W7*2	Nominal	kW	4.5	5.0	5.4
		EER		3.29	3.03	3.00
	A35W18*2	Nominal	kW	5.6	6.0	6.3
		EER		4.97	4.88	4.80
PWL (Heating)*5		dB(A)	58	60	62	
Max operating current		A	13.9	13.9	13.9	
Breaker size		A	16	16	16	
Piping	Diameter	Liquid/Gas	mm	6.35 / 12.7	6.35 / 12.7	6.35 / 12.7
	Length	Out-In	m	5-30	5-30	5-30
	Height	Out-In	m	Max 30	Max 30	Max 30
Guaranteed Operating Range	Heating	°C	-20°C-24°C	-20°C-24°C	-20°C-24°C	
	DHW	°C	-20°C-35°C	-20°C-35°C	-20°C-35°C	
	Cooling	°C	10°C-46°C	10°C-46°C	10°C-46°C	

## Outdoor unit

Model name		Power Inverter, Heating only				ZUBADAN, Heating only						
Refrigerant		PUD-SWM60VAA	PUD-SWM80V/YAA	PUD-SWM100V/YAA	PUD-SWM120V/YAA	R32*1						
Dimensions		1020x1050x480	1020x1050x480	1020x1050x480	1020x1050x480	1020x1050x480	1020x1050x480	1020x1050x480	1020x1050x480	1020x1050x480	1020x1050x480	
Weight	kg	101	101/114	105/118	105/118	102	102/115	108/121	108/121	110/122		
Power supply (V / Phase / Hz)		VAA: 230 / 1-ph / 50, YAA: 400 / 3-ph / 50										
Heating	A7W35*2	Nominal	kW	5.0	6.0	8.0	10.0	5.0	6.0	8.0	10.0	12.0
		COP		4.76	4.76	5.00	4.70	4.99	5.03	5.00	4.80	4.70
	A2W35*2	Nominal	kW	6.0	8.0	10.0	12.0	6.0	8.0	10.0	12.0	14.0
		COP		3.60	3.55	3.30	3.24	3.80	3.75	3.45	3.30	3.05
Average climate water outlet 35°C*3		Class	A+++	A+++	A+++	A+++	A+++	A+++	A+++	A+++	A+++	
		ηs	175	178/176	178/177	177/176	178	181/179	180/178	179/177	179/177	
Average climate water outlet 55°C*3		Class	A++	A++	A++	A++	A++	A++	A++	A++	A++	
		ηs	130	131/130	131/130	129/128	134	135/134	136/135	135/134	134/134	
DHW 200(L)/300(L) Load Profile (Average climate)*4		Class	A+ / A	A+ / A	A+ / A	A+ / A	A+ / A	A+ / A	A+ / A	A+ / A	A+ / A	
		ηwh	148/121	148/121	148/121	148/121	148/121	148/121	148/121	148/121	145/121	
Max outlet water temperature (°C)			60	60	60	60	60	60	60	60	60	
PWL (Heating)*5		dB(A)	55	56	59	60	55	56	59	60	62	
Max operating current		A	16.5	22/8	26/10	28/12	16.5	22/8	26/10	28/12	35/12	
Breaker size		A	20	25/16	30/16	32/16	20	25/16	30/16	32/16	40/16	
Piping	Diameter	Liquid/Gas	mm	6.35/12.7	6.35/12.7	6.35/12.7	6.35/12.7	6.35/12.7	6.35/12.7	6.35/12.7	6.35/12.7	
	Length	Out-In	m	2 - 30	2 - 30	2 - 30	2 - 30	2 - 30	2 - 30	2 - 30	2 - 25	
	Height	Out-In	m	Max. 30	Max. 30	Max. 30	Max. 30	Max. 30	Max. 30	Max. 30	Max. 25	
Guaranteed Operating Range	Heating	°C	-25°C-24°C	-25°C-24°C	-25°C-24°C	-25°C-24°C	-28°C-24°C	-28°C-24°C	-28°C-24°C	-28°C-24°C	-28°C-24°C	
	DHW	°C	-25°C-35°C	-25°C-35°C	-25°C-35°C	-25°C-35°C	-28°C-35°C	-28°C-35°C	-28°C-35°C	-28°C-35°C	-28°C-35°C	

\*1 Refrigerant leakage contribute to climate change. Refrigerant with lower global warming potential (GWP) would contribute less to global warming than a refrigerant with higher GWP, if leaked to the atmosphere. This appliance contains a refrigerant fluid with a GWP equal to 550. This means that if 1 kg of this refrigerant fluid would be leaked to the atmosphere, the impact on global warming would be 550 times higher than 1 kg of CO<sub>2</sub> over a period of 100 years. Never try to interfere with the refrigerant circuit yourself or disassemble the product yourself and always ask a professional. The GWP of R32 is 675 in the IPCC 4th Assessment Report.

\*2 Air-to-Water values are measured based on EN14511 (Circulation pump input is not included.).

\*3 ηs values are measured based on EN14825. \*4 ηwh values are measured based on EN16147. \*5 Sound power levels are measured based on EN12102.

R32	Split type	Small capacity (Under 5kW)*	Medium capacity (6.0kW-14kW)*
			PUD-SHWM60/80/100/120/140
			PUD-SWM60/80/100/120
<b>Eco Inverter</b>			
		SUZ-SWM40/60	SUZ-SWM80

\*Rated capacity is at conditions A2W35. (according to EN14511)

# Split Type Specifications

## Outdoor unit

Model name		Power Inverter						
Refrigerant		PUHZ-SW75V/YAA(-BS)	PUHZ-SW100V/YAA(-BS)	PUHZ-SW120V/YHA(-BS)	PUHZ-SW160YKA(-BS)	PUHZ-SW200YKA(-BS)		
Dimensions		R410A*1						
HxWxD	mm	1020x1050x480	1020x1050x480	1350x950x330	1338x1050x330	1338x1050x330		
Weight	kg	92/104	114/126	118/130	136	136		
Power supply (V / Phase / Hz)		VAA, VHA: 230 / 1-ph / 50, YAA, YHA, YKA: 400 / 3-ph / 50						
Heating	A7W35*2	Nominal	kW	8.0	11.2	16.0	22.0	25.0
		COP		4.40	4.46	4.10	4.20	4.00
	A2W35*2	Nominal	kW	7.5	10.0	12.0	16.0	20.0
		COP		3.40	3.32	3.24	3.11	2.80
Average climate water outlet 35°C*3		Class	A++	A++	A++	A++	A++	
		ηs	162/160	167/165	162/162	161	163	
Average climate water outlet 55°C*3		Class	A++	A++	A++	A++	A++	
		ηs	129/128	130/129	125/125	125	127	
DHW 200(L)/300(L) Load Profile (Average climate)*4		Class	A+ / A	A+ / A	A+ / A	-	-	
		ηwh	145/120	145/120	138/118	-	-	
Max outlet water temperature (°C)			60	60	60	-	-	
Cooling	A35W7*2	Nominal	kW	7.1	10.0	12.5	16.0	20.0
		EER		2.70	2.83	2.32	2.76	2.25
	A35W18*2	Nominal	kW	7.1	10.0	14.0	18.0	22.0
		EER		4.43	4.47	4.08	4.56	4.1
PWL (Heating)*5		dB(A)	58	60	72	78	78	
Max operating current		A	22.0/11.5	28.0/12.0	29.5/13.0	19.0	21.0	
Breaker size		A	25/16	32/16	32/16	25	32	
Piping	Diameter	Liquid/Gas	mm	9.52/15.88	9.52/15.88	9.52/15.88	9.52/25.4	12.7/25.4
	Length	Out-In	m	40	75	75	80	80
	Height	Out-In	m	10	10	30	30	30
Guaranteed Operating Range	Heating	°C	-20°C-21°C	-20°C-21°C	-20°C-21°C	-20°C-21°C	-20°C-21°C	
	DHW	°C	-20°C-35°C	-20°C-35°C	-20°C-35°C	-20°C-35°C	-20°C-35°C	
	Cooling	°C	-15°C-46°C	-15°C-46°C	-15°C-46°C	-15°C-46°C	-15°C-46°C	

Model name		ZUBADAN					
Refrigerant		PUHZ-SHW80V/YAA(-BS)	PUHZ-SHW112V/YAA(-BS)	PUHZ-SHW140YHA(-BS)	PUHZ-SHW230YKA2		
Dimensions		R410A*1					
HxWxD	mm	1020x1050x480	1020x1050x480	1350x950x330	1338x1050x330		
Weight	kg	116/128	116/128	134	143		
Power supply (V / Phase / Hz)		VAA, VHA: 230 / 1-ph / 50, YAA, YHA, YKA: 400 / 3-ph / 50					
Heating	A7W35*2	Nominal	kW	8.0	11.2	14.0	23.0
		COP		4.65	4.40	4.22	3.65
	A2W35*2	Nominal	kW	8.0	11.2	14.0	23.0
		COP		3.55	3.22	2.96	2.37
Average climate water outlet 35°C*3		Class	A++	A++	A++	A++	
		ηs	169/167	171/169	163	164	
Average climate water outlet 55°C*3		Class	A++	A++	A++	A++	
		ηs	133/132	135/135	127	127	
DHW 200(L)/300(L) Load Profile (Average climate)*4		Class	A+ / A	A+ / A	A+ / A	-	
		ηwh	145/120	145/120	138/118	-	
Max outlet water temperature (°C)			60	60	60	60	
Cooling	A35W7*2	Nominal	kW	7.1	10.0	12.5	20.0
		EER		3.31	2.83	2.17	2.22
	A35W18*2	Nominal	kW	7.1	10	12.5	20.0
		EER		4.52	4.74	4.26	3.55
PWL (Heating)*5		dB(A)	59	60	70	75	
Max operating current		A	22/13	28/13	13	20	
Breaker size		A	25/16	32/16	16	25	
Piping	Diameter	Liquid/Gas	mm	9.52/15.88	9.52/15.88	9.52/15.88	12.7/25.4
	Length	Out-In	m	75	75	75	80
	Height	Out-In	m	30	30	30	30
Guaranteed Operating Range	Heating	°C	-28°C-21°C	-28°C-21°C	-28°C-21°C	-25°C-21°C	
	DHW	°C	-28°C-35°C	-28°C-35°C	-28°C-35°C	-25°C-35°C	
	Cooling	°C	-15°C-46°C	-15°C-46°C	-15°C-46°C	-15°C-46°C	

\*1 Refrigerant leakage contribute to climate change. Refrigerant with lower global warming potential (GWP) would contribute less to global warming than a refrigerant with higher GWP, if leaked to the atmosphere. This appliance contains a refrigerant fluid with a GWP equal to 550. This means that if 1 kg of this refrigerant fluid would be leaked to the atmosphere, the impact on global warming would be 550 times higher than 1 kg of CO<sub>2</sub> over a period of 100 years. Never try to interfere with the refrigerant circuit yourself or disassemble the product yourself and always ask a professional. The GWP of R410A is 2088 in the IPCC 4th Assessment Report.

\*2 Air-to-Water values are measured based on EN14511 (Circulation pump input is not included.).

\*3 ηs values are measured based on EN14825. \*4 ηwh values are measured based on EN16147. \*5 Sound power levels are measured based on EN12102.

R410A	Split type	Medium capacity (7.5kW-14kW)	Large capacity (≥16kW)
		PUHZ-SHW80/112AA	PUHZ-SHW140
		PUHZ-SW75/100AA	PUHZ-SW120
			PUHZ-SW160/200



# Packaged Type Specifications

## Indoor unit

### <Cylinder unit (Heating only)>

Model name		EHPT17X-VM2D	EHPT17X-VM6D	EHPT17X-VM9D	EHPT20X-MED	EHPT20X-VM6D	EHPT20X-VM9D	EHPT20X-VM9ED	EHPT20X-TM9D	EHPT20X-MHEDW	EHPT30X-MED	EHPT30X-VM9ED		
Type	Type	Heating only												
	Immersion heater	-	-	-	-	-	-	-	-	-	-	-		
	Expansion vessel	✓	✓	✓	-	✓	✓	✓	✓	✓	-	-		
	Booster heater	✓	✓	✓	-	✓	✓	✓	✓	✓	-	✓		
Dimensions	HxWxD	1400×595×680						1600×595×680				2050×595×680		
Weight (empty)	kg	86	87	89	87	94	96	90	96	94	106	110		
Control board power supply (Phase / V / Hz)		~N, 230V, 50Hz												
Heater	Booster heater <sup>2</sup>	Power supply (Phase / V / Hz)	~N, 230V, 50Hz		~N, 230V, 50Hz		3~, 400V, 50Hz		~N, 230V, 50Hz		~N, 230V, 50Hz		~N, 230V, 50Hz	
		Capacity	kW	2	2+4	3+6	-	2+4	3+6	3+6	3+6	-	-	3+6
		Current	A	9	26	13	-	26	13	23	-	-	-	13
		Breaker size	A	16	32	16	-	32	16	16	32	-	-	16
Immersion heater	Power supply (Phase / V / Hz)	~N, 230V, 50Hz												
	Capacity	kW	-	-	-	-	-	-	-	-	~N, 230V, 50Hz	-	-	
	Current	A	-	-	-	-	-	-	-	-	3	-		
	Breaker size	A	-	-	-	-	-	-	-	-	13	-		
Domestic hot water tank	Volume / Material	L / -	170 / Stainless steel (Net)				200 / Stainless steel (Net)				300 / Stainless steel (Net)			
Guaranteed operating range <sup>1</sup>	Ambient	°C	0 - 35 (≤80%RH)											
	Outdoor	Heating	°C	See outdoor unit spec table										
Target temperature range	Heating	Room temperature	°C	10-30										
		Flow temperature	°C	20-60										
	Cooling	Room temperature	°C	-										
		Flow temperature	°C	-										
DHW tank performance	Max. hot water temperature	°C	70				*3				70			
	Water heater energy efficiency class		A+				A				A			
Sound power level (PWL)		40												

\*1 The indoor environment must be frost-free.

\*2 Do not fit immersion heaters without thermal cut-out. Use only Mitsubishi Electric service parts as a direct replacement.

\*3 For the model without booster heater and immersion heater, the maximum allowable hot water temperature is 3°C lower than maximum outlet water of outdoor unit. For the maximum outlet water of outdoor unit, refer to outdoor unit data book.

### <Cylinder unit (Reversible)>

Model name		ERPT17X-VM2D	ERPT20X-MD	ERPT20X-VM2D	ERPT20X-VM6D	ERPT30X-VM2ED	ERPT30X-VM6ED		
Type	Type	Heating and cooling							
	Immersion heater	-	-	-	-	-	-		
	Expansion vessel	✓	✓	✓	✓	✓	✓		
	Booster heater	✓	✓	✓	✓	✓	✓		
Dimensions	HxWxD	1400×595×680		1600×595×680		2050×595×680			
Weight (empty)	kg	86	93	94	95	107	108		
Control board power supply (Phase / V / Hz)		~N, 230V, 50Hz							
Heater	Booster heater	Power supply (Phase / V / Hz)	~N, 230V, 50Hz		~N, 230V, 50Hz				
		Capacity	kW	2	-	2	2+4	2	2+4
		Current	A	9	-	9	26	9	26
		Breaker size	A	16	-	16	32	16	32
Immersion heater <sup>2</sup>	Power supply (Phase / V / Hz)	~N, 230V, 50Hz							
	Capacity	kW	-	-	-	-	-	-	
	Current	A	-	-	-	-	-	-	
	Breaker size	A	-	-	-	-	-	-	
Domestic hot water tank	Volume / Material	L / -	170 / Stainless steel (Net)		200 / Stainless steel (Net)		300 / Stainless steel (Net)		
Guaranteed operating range <sup>1</sup>	Ambient	°C	0 - 35 (≤80%RH)						
	Outdoor	Heating	°C	See outdoor unit spec table					
Target temperature range	Heating	Room temperature	°C	10-30					
		Flow temperature	°C	20-60					
	Cooling	Room temperature	°C	-					
		Flow temperature	°C	-					
DHW tank performance	Max. hot water temperature	°C	70		*3		70		
	Water heater energy efficiency class		A+		A		A		
Sound power level (PWL)		40							

\*1 The indoor environment must be frost-free.

\*2 Do not fit immersion heaters without thermal cut-out. Use only Mitsubishi Electric service parts as a direct replacement.

\*3 For the model without booster heater and immersion heater, the maximum allowable hot water temperature is 3°C lower than maximum outlet water of outdoor unit. For the maximum outlet water of outdoor unit, refer to outdoor unit data book.

\*4 During cooling operation at low outdoor temperature (10°C or lower), frozen water may cause damage on plate heat exchanger.

# Packaged Type Specifications

### <Hydrobox (Heating only)>

Model name		EHPX-MED	EHPX-VM2D	EHPX-VM6D	EHPX-VM9D	EHPX-VM9ED		
Type	Type	Heating only						
	Immersion heater	-	-	-	-	-		
	Expansion vessel	-	✓	✓	✓	-		
	Booster heater	-	✓	✓	✓	✓		
Dimensions	HxWxD	800×530×360						
Weight (empty)	kg	25	32	33	33	28		
Control board power supply (Phase / V / Hz)		~N, 230V, 50Hz						
Heater	Booster heater	Power supply (Phase / V / Hz)	~N, 230V, 50Hz		3~, 400V, 50Hz			
		Capacity	kW	-	2	2+4	3+6	3+6
		Current	A	-	9	26	13	13
		Breaker size	A	-	16	32	16	16
Guaranteed operating range <sup>1</sup>	Ambient	°C	0-35 (≤80%RH)					
	Outdoor	Heating	°C	See outdoor unit spec table				
Target temperature range	Heating	Room temperature	°C	10-30				
		Flow temperature	°C	20-60				
	Cooling	Room temperature	°C	-				
		Flow temperature	°C	-				
Sound power level (PWL)		40						

\*1 The indoor environment must be frost-free.

### <Hydrobox (Reversible)>

Model name		ERPX-MD	ERPX-VM2D	ERPX-VM6D	ERPX-VM9D		
Type	Type	Heating and cooling					
	Immersion heater	-	-	-	-		
	Expansion vessel	✓	✓	✓	✓		
	Booster heater	-	✓	✓	✓		
Dimensions	HxWxD	800×530×360					
Weight (empty)	kg	30	33	34	35		
Control board power supply (Phase / V / Hz)		~N, 230V, 50Hz					
Heater	Booster heater	Power supply (Phase / V / Hz)	~N, 230V, 50Hz		3~, 400V, 50Hz		
		Capacity	kW	-	2	2+4	3+6
		Current	A	-	9	26	13
		Breaker size	A	-	16	32	16
Guaranteed operating range <sup>1</sup>	Ambient	°C	0-35 (≤80%RH)				
	Outdoor	Heating	°C	See outdoor unit spec table			
Target temperature range	Heating	Room temperature	°C	10-30			
		Flow temperature	°C	20-60			
	Cooling	Room temperature	°C	-			
		Flow temperature	°C	-			
Sound power level (PWL)		40					

\*1 The indoor environment must be frost-free.

\*2 If you use our system in cooling mode at the low ambient temperature (10°C or below), there are some risks of plate heat exchanger breaking by frozen water.

## Packaged type

Small capacity (Under 5kW)\*

Medium capacity (6.0kW-14kW)\*



PUZ-HWM140

\*Rated capacity is at conditions A2W35. (according to EN14511)

## Packaged type

Small capacity (Under 5kW)\*

Medium capacity (6.0kW-11.2kW)\*



PUZ-WM50



PUHZ-WM60/85/112

\*Rated capacity is at conditions A2W35. (according to EN14511)

## Outdoor unit

Model name		PUZ-WM50VHA	PUZ-WM60VAA	PUZ-WM85V/YAA	PUZ-WM112V/YAA	PUZ-HWM140V/YHA		
Refrigerant		R32 <sup>1</sup>						
Dimensions	HxWxD	mm	943×950×330	1020×1050×480	1020×1050×480	1350×1020×330		
Weight	kg	71	98	98/111	119/132	132/143		
Power supply (V / Phase / Hz)		VHA + VAA: 230 / 1-ph / 50, YHA + YAA: 400 / 3-ph / 50						
Heating	A7W35 <sup>2</sup>	Nominal	kW	5.0	6.0	8.5	11.2	14.0
		COP		5.00	5.06	4.80	4.70	4.46
	A2W35 <sup>2</sup>	Nominal	kW	5.0	6.0	8.5	11.2	14.0
		COP		3.70	3.75	3.51	3.44	3.15
Average climate water outlet 35°C <sup>3</sup>		Class	A+++	A+++	A+++	A+++	A+++	
		ηs	183	190	193/190	191/189	176/175	
Average climate water outlet 55°C <sup>3</sup>		Class	A++	A++	A++	A++	A++	
		ηs	129	142	139/138	134/133	132/131	
DHW 200(L) Load Profile (Average climate) <sup>4</sup>		Class	A*	A*	A*	A*	A*	
		ηwh	135	145	145	148	130	
Max outlet water temperature (°C)			60	60	60	60	60	
Cooling	A35W7 <sup>2</sup>	Nominal	kW	4.5	6.0	7.5	10.0	11.9
		EER		3.40	3.30	3.15	3.30	3.00
	A35W18 <sup>2</sup>	Nominal	kW	4.5	6.0	7.5	10.0	11.1
		EER		5.00	4.45	4.90	4.90	4.10
PWL (Heating) <sup>5</sup>			dB(A)	61	58	58	60	67
Max operating current		A	13.0	13.0	22.0/11.5	28.0/13.0	35.0/13.0	
Breaker size		A	16	16	25/16	32/16	40/16	
Piping	Diameter	Liquid/Gas	mm	-	-	-	-	
	Length	Out-In	m	-	-	-	-	
	Height	Out-In	m	-	-	-	-	
Guaranteed Operating Range	Heating	°C	-20°C-21°C	-20°C-21°C	-20°C-21°C	-25°C-21°C	-28°C-21°C	
	DHW	°C	-20°C-35°C	-20°C-35°C	-20°C-35°C	-25°C-35°C	-28°C-35°C	
	Cooling	°C	10°C-46°C	10°C-46°C	10°C-46°C	10°C-46°C	10°C-46°C	

\*1 Refrigerant leakage contribute to climate change. Refrigerant with lower global warming potential (GWP) would contribute less to global warming than a refrigerant with higher GWP, if leaked to the atmosphere. This appliance contains a refrigerant fluid with a GWP equal to 550. This means that if 1 kg of this refrigerant fluid would be leaked to the atmosphere, the impact on global warming would be 550 times higher than 1 kg of CO<sub>2</sub> over a period of 100 years. Never try to interfere with the refrigerant circuit yourself or disassemble the product yourself and always ask a professional. The GWP of R32 is 675 in the IPCC 4th Assessment Report.

\*2 Air-to-Water values are measured based on EN14511 (Circulation pump input is not included).

\*3 ηs values are measured based on EN14825.

\*4 ηwh values are measured based on EN16147.

\*5 Sound power levels are measured based on EN12102.

## Optional Parts

### Split type <Indoor unit>

Parts name	Model name	Cylinder	Hydrobox	Remarks
Wireless remote controller	PAR-WT50R-E	✓	✓	
Wireless receiver	PAR-WR51R-E	✓	✓	
Thermistors	PAC-SE41TS-E	✓	✓	For room temp.
	PAC-TH011-E	✓	✓	For buffer and zone (flow and return temp.)
	PAC-TH011TK2-E	-	✓	For tank temp. (5m)
	PAC-TH011TKL2-E	-	✓	For tank temp. (30m)
	PAC-TH012HT-E	✓	✓	For boiler and buffer (5m)
	PAC-TH012HTL-E	✓	✓	For boiler and buffer (30m)
Immersion heater	PAC-IH01V2-E	✓	-	1Ph 1kW
	PAC-IH03V2-E	✓	-	1Ph 3kW
Joint pipe	PAC-SG72RJ-E	✓	✓	For PUHZ-SW75 ø6.35 → ø9.52
	PAC-SG73RJ-E	-	✓	For PUHZ-SW200YKA/SHW230YKA2 ø9.52 → ø12.7
	PAC-SG74RJ-E	✓	✓	For PUHZ-SW75 ø12.7 → ø15.88
	PAC-SH30RJ-E	✓	✓	For PUHZ-SW75AA ø9.52 → 6.35
	PAC-SH50RJ-E	✓	✓	For PUHZ-SW75AA ø15.88 → 12.7
Wi-Fi interface	MAC-567IF-E	✓	✓	
2 Zone kit	PAC-TZ02-E	✓	✓	
Expansion vessel	PAC-EVP12-E1	✓	-	12L

### <Outdoor unit>

Parts name	Model name	R32 (Eco Inverter)			R32 Heating only (Power Inverter)				R32 Heating only (ZUBADAN)			
		SUZ-SWM40VA	SUZ-SWM60VA	SUZ-SWM80VA	PUD-SWM80VAA	PUD-SWM80VYA	PUD-SWM100VYA	PUD-SWM120VYA	PUD-SHM80VYA	PUD-SHM100VYA	PUD-SHM120VYA	PUD-SHM140VYA
Connector for drain hose heater signal output	PAC-SE60RA-E	-	-	-	✓	✓	✓	✓	✓	✓	✓	✓
Air discharge guide	MAC-886SG-E	✓	✓	✓	-	-	-	-	-	-	-	-
	PAC-SG59SG-E	-	-	-	-	-	-	-	-	-	-	-
	PAC-SH96SG-E*1	-	-	-	✓*1	✓*1	✓*1	✓*1	✓*1	✓*1	✓*1	✓*1
Air protection guide	PAC-SH63AG-E	-	-	-	-	-	-	-	-	-	-	-
	PAC-SH95AG-E*1	-	-	-	✓*1	✓*1	✓*1	✓*1	✓*1	✓*1	✓*1	✓*1
Attachment	PAC-SJ82AT-E	-	-	-	✓	✓	✓	✓	✓	✓	✓	✓
Drain socket*2	PAC-SG61DS-E	-	-	-	✓	✓	✓	✓	✓	✓	✓	✓
Centralized drain pan*2	PAC-SG64DP-E	-	-	-	-	-	-	-	-	-	-	-
	PAC-SH97DP-E	-	-	-	-	-	-	-	-	-	-	-
	PAC-SJ83DP-E	-	-	-	✓	✓	✓	✓	✓	✓	✓	✓
Base heater	MAC-642BH-U1	✓	✓	✓	-	-	-	-	-	-	-	-
Control/Service tool	PAC-SK52ST	-	-	-	✓	✓	✓	✓	✓	✓	✓	✓

\*1 Attachment (PAC-SJ82AT-E) is necessary for the Air guide

\*2 Cannot be used for cold climate.

Parts name	Model name	R410A (Power Inverter)				R410A (ZUBADAN)				
		PUHZ-SW75VYAA	PUHZ-SW100VYAA	PUHZ-SW120VYAA	PUHZ-SW180YKA	PUHZ-SW200YKA	PUHZ-SHM80VYA	PUHZ-SHM112VYAA	PUHZ-SHM140VYA	PUHZ-SHW230YKA2
Connector for drain hose heater signal output	PAC-SE60RA-E	✓	✓	✓	✓	✓	✓	✓	✓	✓
Air discharge guide	MAC-886SG-E	-	-	✓	-	-	-	-	-	-
	PAC-SG59SG-E	-	-	✓	-	-	-	-	-	-
	PAC-SH96SG-E	✓	✓	✓	✓	✓	✓	✓	✓	✓
Air protection guide	PAC-SH63AG-E	-	-	✓	-	-	-	-	-	-
	PAC-SH95AG-E	✓	✓	✓	✓	✓	✓	✓	✓	✓
Attachment	PAC-SJ82AT-E	✓	✓	✓	✓	✓	✓	✓	✓	✓
Drain socket*2	PAC-SG61DS-E	✓	✓	✓	✓	✓	✓	✓	✓	✓
Centralized drain pan*2	PAC-SG64DP-E	-	-	✓	-	-	-	-	-	-
	PAC-SH97DP-E	-	-	✓	-	-	-	-	-	-
	PAC-SJ83DP-E	✓	✓	✓	✓	✓	✓	✓	✓	✓
Base heater	MAC-642BH-U1	✓	✓	✓	-	-	-	-	-	-
Control/Service tool	PAC-SK52ST	✓	✓	✓	✓	✓	✓	✓	✓	✓

\*1 Attachment (PAC-SJ82AT-E) is necessary for the Air guide

\*2 Cannot be used for cold climate.

## Interface/Flow Temperature Controller

### Split type

Parts name	Model name	Description
Capacity step control interface	PAC-IF011B-E	1 PC board w/ Case
Flow temperature controller	PAC-IF032B-E	1 PC board w/ Case
	PAC-IF033B-E	1 PC board w/ Case
	PAC-IF033PCB-E	10 PC board w/o case
System Controllers	PAC-IF071B-E	1 PC board w/ Case
Pressure sensor	PAC-PS01-E	For SUZ-SWM40/60/80VA
Flow sensor	PAC-FS01-E	
Thermistor	PAC-TH011-E	

## Optional Parts

### Packaged type <Indoor unit>

Parts name	Model name	Cylinder	Hydrobox	Remarks
Wireless remote controller	PAR-WT50R-E	✓	✓	
Wireless receiver	PAR-WR51R-E	✓	✓	
Thermistors	PAC-SE41TS-E	✓	✓	For room temp.
	PAC-TH011-E	✓	✓	For buffer and zone (flow and return temp.)
	PAC-TH011TK2-E	-	✓	For tank temp. (5m)
	PAC-TH011TKL2-E	-	✓	For tank temp. (30m)
	PAC-TH012HT-E	✓	✓	For boiler and buffer (5m)
	PAC-TH012HTL-E	✓	✓	For boiler and buffer (30m)
Immersion heater	PAC-IH01V2-E	✓ (Except EHPT20X-MHEDW)	-	1Ph 1kW
	PAC-IH03V2-E	✓ (Except EHPT20X-MHEDW)	-	1Ph 3kW
EHPT accessories for UK	PAC-WK02UK-E	✓	-	
Wi-Fi interface	MAC-567IF-E	✓	✓	
2 Zone kit	PAC-TZ02-E	✓	✓	
Expansion vessel	PAC-EVP12-E1	✓	-	12L

### <Outdoor unit>

Parts name	Model name	R32 (Power Inverter)				
		PUZ-WM50VHA	PUZ-WM60VAA	PUZ-WM85VYAA	PUZ-WM112VYAA	PUZ-HWM140V/YHA
Connector for drain hose heater signal output	PAC-SE60RA-E	✓	✓	✓	✓	✓
Air discharge guide	PAC-SG59SG-E	✓	-	-	-	✓
	PAC-SH96SG-E	-	✓*	✓*	✓*	✓*
Air protection guide	PAC-SH63AG-E	✓	-	-	-	✓
	PAC-SH95AG-E	-	✓*	✓*	✓*	✓*
Attachment	PAC-SJ82AT-E	-	✓	✓	✓	✓
Drain socket	PAC-SG61DS-E	✓	✓	✓	✓	✓
Centralized drain pan	PAC-SG64DP-E	✓	-	-	-	✓
	PAC-SJ83DP-E	-	✓	✓	✓	✓

\*Attachment (PAC-SJ82AT-E) is necessary for the Air Guide.



## Ground Source Heat Pump Specifications

Model name		EHGT17D-YM9ED	
Heating Capacity (Min-Max)		2.5-10.0kW	
Heat Output B0/W35 (Rated)		5.0kW	
COP B0/W35		4.58	
SCOP (Average Climate)	Low Temp	5.27	
	Rank	A+++	
	ηs*2	203%	
	Mid Temp	3.96	
L Load Profile (Average Climate)*3	Rank	A+++	
	ηwh	150%	
Sound Power Level (Rated)*4		134%	
Refrigerant /Amount		A+	
GWP		42dB(A)	
DHW Tank		R32*1)0.9kg	
Weight		608	
Dimensions (HxWxD)		1,750mm×595mm×680mm	
Electrical data		170L (Net)	
Connections	Water	Heat pump	Unit 181kg
		Booster heater	3ph/400V/50Hz
Operating range	Heating	Power supply	3ph/400V/50Hz
		Breaker	16A
Guaranteed operating range	DHW	Capacity	3kW+6kW
		Current	13A
Flow rate range	Primary circuit	Breaker	16A
		Min.	27.7L/min
Heat source fluid type	Brine circuit	Max.	7.1L/min
		Min.	27.7L/min
		Max.	7.1L/min
		Min.	29 WT% Bioethanol
			38 WT% Propylene glycol
			25 WT% Ethylene glycol

\*1 Refrigerant leakage contribute to climate change. Refrigerant with lower global warming potential (GWP) would contribute less to global warming than a refrigerant with higher GWP, if leaked to the atmosphere. This appliance contains a refrigerant fluid with a GWP equal to 550. This means that if 1 kg of this refrigerant fluid would be leaked to the atmosphere, the impact on global warming would be 550 times higher than 1 kg of CO<sub>2</sub> over a period of 100 years. Never try to interfere with the refrigerant circuit yourself or disassemble the product yourself and always ask a professional. The GWP of R32 is 675 in the IPCC 4th Assessment Report.

\*2 ηs values are measured based on EN14825. \*3 ηwh values are measured based on EN16147. \*4 Sound power levels are measured based on EN12102.

## Interface/Flow Temperature Controller

### Packaged type

Parts name	Model name	Description
Flow temperature controller	PAC-IF033B-E	1 PC board w/ Case
	PAC-IF033PCB-E	10 PC board w/o case
System Controllers	PAC-IF072B-E	
Flow sensor	PAC-FS01-E	
Thermistor	PAC-TH011-E	





All A++ or Above!!

Outdoor unit	Indoor unit	For medium-temperature application										For low-temperature application											
		Seasonal space heating energy efficiency class		Seasonal space heating energy efficiency class		Rated heat output under average climate conditions		Seasonal space heating energy efficiency under average climate conditions		Water heating energy efficiency under average climate conditions		Rated heat output under warmer climate condition		Seasonal space heating energy efficiency under warmer climate condition		Warmer heating energy efficiency under warmer climate conditions		Sound power level LWA indoor		Sound power level LWA outdoor			
		A++	A+	kW	%	kW	%	%	%	kW	%	%	%	kW	%	%	%	kW	%	%	%	kW	%
SUZ-SWM40VA	EHST17D-***D	A++	A+	4.6	129	148	4.6	155	167	41	58	A+++	A+	5.1	180	148	5.1	216	167	41	58		
	ERST17D-***D	A++	A+	4.6	132	148	4.6	160	167	41	58	A+++	A+	5.1	187	148	5.1	225	167	41	58		
	EHST20D-***D	A++	A+	4.6	129	159	4.6	155	173	41	58	A+++	A+	5.1	180	159	5.1	216	173	41	58		
	ERST20D-***D	A++	A+	4.6	132	159	4.6	160	173	41	58	A+++	A+	5.1	187	159	5.1	225	173	41	58		
	EHST30D-***D	A++	A+	4.6	129	128	4.6	155	149	41	58	A+++	A+	5.1	180	128	5.1	216	149	41	58		
	ERST30D-***D	A++	A+	4.6	132	128	4.6	160	149	41	58	A+++	A+	5.1	187	128	5.1	225	149	41	58		
	EHSD-***D	A++	-	4.6	129	-	4.6	155	-	41	58	A+++	-	5.1	180	-	5.1	216	-	41	58		
	ERSD-***D	A++	-	4.6	132	-	4.6	160	-	41	58	A+++	-	5.1	187	-	5.1	225	-	41	58		
SUZ-SWM60VA	EHST17D-***D	A++	A+	6.0	130	144	6.0	138	167	41	60	A+++	A+	6.6	181	144	6.6	192	167	41	60		
	ERST17D-***D	A++	A+	6.0	133	144	6.0	142	167	41	60	A+++	A+	6.6	187	144	6.6	198	167	41	60		
	EHST20D-***D	A++	A+	6.0	130	148	6.0	138	173	41	60	A+++	A+	6.6	181	148	6.6	192	173	41	60		
	ERST20D-***D	A++	A+	6.0	133	148	6.0	142	173	41	60	A+++	A+	6.6	187	148	6.6	198	173	41	60		
	EHST30D-***D	A++	A+	6.0	130	128	6.0	138	164	41	60	A+++	A+	6.6	181	128	6.6	192	164	41	60		
	ERST30D-***D	A++	A+	6.0	133	128	6.0	142	164	41	60	A+++	A+	6.6	187	128	6.6	198	164	41	60		
	EHSD-***D	A++	-	6.0	130	-	6.0	138	-	41	60	A+++	-	6.6	181	-	6.6	192	-	41	60		
	ERSD-***D	A++	-	6.0	133	-	6.0	142	-	41	60	A+++	-	6.6	187	-	6.6	198	-	41	60		
SUZ-SWM80VA	EHST17D-***D	A++	A+	7.1	131	144	7.1	135	167	41	62	A+++	A+	7.1	182	144	7.1	186	167	41	62		
	ERST17D-***D	A++	A+	7.1	133	144	7.1	138	167	41	62	A+++	A+	7.1	187	144	7.1	191	167	41	62		
	EHST20D-***D	A++	A+	7.1	131	148	7.1	135	173	41	62	A+++	A+	7.1	182	148	7.1	186	173	41	62		
	ERST20D-***D	A++	A+	7.1	133	148	7.1	138	173	41	62	A+++	A+	7.1	187	148	7.1	191	173	41	62		
	EHST30D-***D	A++	A+	7.1	131	128	7.1	135	164	41	62	A+++	A+	7.1	182	128	7.1	186	164	41	62		
	ERST30D-***D	A++	A+	7.1	133	128	7.1	138	164	41	62	A+++	A+	7.1	187	128	7.1	191	164	41	62		
	EHSD-***D	A++	-	7.1	131	-	7.1	135	-	41	62	A+++	-	7.1	182	-	7.1	186	-	41	62		
	ERSD-***D	A++	-	7.1	133	-	7.1	138	-	41	62	A+++	-	7.1	187	-	7.1	191	-	41	62		
PUD-SWM80V/YAA(-BS)	E*ST17D-***D	A++	A+	8.0	131/130	136	8.0	161/159	154	41	56	A+++	A+	8.0	178/176	136	8.0	218/215	154	41	56		
	E*ST20D-***D	A++	A+	8.0	131/130	148	8.0	161/159	162	41	56	A+++	A+	8.0	178/176	148	8.0	218/215	162	41	56		
	E*ST30D-***D	A++	A	8.0	131/130	121	8.0	161/159	145	41	56	A+++	A	8.0	178/176	121	8.0	218/215	145	41	56		
	E*SD-***D	A++	-	8.0	131/130	-	8.0	161/159	-	41	56	A+++	-	8.0	178/176	-	8.0	218/215	-	41	56		
PUD-SWM100V/YAA(-BS)	E*ST20D-***D	A++	A+	10.0	131/130	148	10.0	152/151	162	41	59	A+++	A+	10.0	178/177	148	10.0	221/218	162	41	59		
	E*ST30D-***D	A++	A	10.0	131/130	121	10.0	152/151	145	41	59	A+++	A	10.0	178/177	121	10.0	221/218	145	41	59		
	E*SD-***D	A++	-	10.0	131/130	-	10.0	152/151	-	41	59	A+++	-	10.0	178/177	-	10.0	221/218	-	41	59		
PUD-SWM120V/YAA(-BS)	E*ST20D-***D	A++	A+	12.0	129/128	148	12.0	150/149	162	41	60	A+++	A+	12.0	177/176	148	12.0	217/215	162	41	60		
	E*ST30D-***D	A++	A	12.0	129/128	121	12.0	150/149	145	41	60	A+++	A	12.0	177/176	121	12.0	217/215	145	41	60		
	E*SD-***D	A++	-	12.0	129/128	-	12.0	150/149	-	41	60	A+++	-	12.0	177/176	-	12.0	217/215	-	41	60		
	E*SD-***D	A++	-	12.0	129/128	-	12.0	150/149	-	41	60	A+++	-	12.0	177/176	-	12.0	217/215	-	41	60		
PUD-SHWM80V/YAA(-BS)	E*ST17D-***D	A++	A+	8.0	135/134	136	8.0	166/164	154	41	56	A+++	A+	8.0	181/179	136	8.0	225/222	154	41	56		
	E*ST20D-***D	A++	A+	8.0	135/134	148	8.0	166/164	162	41	56	A+++	A+	8.0	181/179	148	8.0	225/222	162	41	56		
	E*ST30D-***D	A++	A	8.0	135/134	121	8.0	166/164	145	41	56	A+++	A	8.0	181/179	121	8.0	225/222	145	41	56		
	E*SD-***D	A++	-	8.0	135/134	-	8.0	166/164	-	41	56	A+++	-	8.0	181/179	-	8.0	225/222	-	41	56		

Note: E\*\*T17/20\*...D use "Load profile L"  
E\*\*T30\*...D use "Load profile XL"

Outdoor unit	Indoor unit	For medium-temperature application										For low-temperature application											
		Seasonal space heating energy efficiency class		Water heating energy efficiency class		Rated heat output under average climate conditions		Seasonal space heating energy efficiency under average climate conditions		Water heating energy efficiency under average climate conditions		Rated heat output under warmer climate condition		Seasonal space heating energy efficiency under warmer climate condition		Warmer heating energy efficiency under warmer climate conditions		Sound power level LWA indoor		Sound power level LWA outdoor			
		A++	A+	kW	%	kW	%	%	%	kW	%	%	%	kW	%	%	%	kW	%	%	%	kW	%
PUD-SHWM100V/YAA(-BS)	E*ST20D-***D	A++	A+	10.0	136/135	148	10.0	163/161	162	41	59	A+++	A+	10.0	180/178	148	10.0	235/232	162	41	59		
	E*ST30D-***D	A++	A	10.0	136/135	121	10.0	163/161	145	41	59	A+++	A	10.0	180/178	121	10.0	235/232	145	41	59		
	E*SD-***D	A++	-	10.0	136/135	-	10.0	163/161	-	41	59	A+++	-	10.0	180/178	-	10.0	235/232	-	41	59		
PUD-SHWM120V/YAA(-BS)	E*ST20D-***D	A++	A+	12.0	135/134	148	12.0	159/158	162	41	60	A+++	A+	12.0	179/177	148	12.0	231/229	162	41	60		
	E*ST30D-***D	A++	A	12.0	135/134	121	12.0	159/158	145	41	60	A+++	A	12.0	179/177	121	12.0	231/229	145	41	60		
	E*SD-***D	A++	-	12.0	135/134	-	12.0	159/158	-	41	60	A+++	-	12.0	179/177	-	12.0	231/229	-	41	60		
PUD-SHWM140V/YAA(-BS)	E*ST20D-***D	A++	A+	14.0	134/134	145	14.0	161/139	161	41	62	A+++	A+	14.0	179/177	145	14.0	224/223	161	41	62		
	E*ST30D-***D	A++	A	14.0	134/134	121	14.0	161/139	139	41	62	A+++	A	14.0	179/177	121	14.0	224/223	139	41	62		
	E*SD-***D	A++	-	14.0	134/134	-	14.0	161/139	-	41	62	A+++	-	14.0	179/177	-	14.0	224/223	-	41	62		
PUHZ-SW75V/YAA(-BS)	EHST17D-***D	A++	A+	7.1	129/128	136	7.1	155/153	141	41	58	A++	A+	7.2	162/160	136	7.1	219/215	141	41	58		
	ERST17D-***D	A++	A+	7.1	132/132	136	7.1	158	141	41	58	A++	A+	7.2	166/165	136	7.1	226/225	141	41	58		
	EHST20D-***D	A++	A+	7.1	129/128	145	7.1	155/153	161	41	58	A++	A+	7.2	162/160	145	7.1	219/215	161	41	58		
	ERST20D-***D	A++	A+	7.1	132/132	145	7.1	158	161	41	58	A++	A+	7.2	166/165	145	7.1	226/225	161	41	58		
	EHST30D-***D	A++	A	7.1	129/128	120	7.1	155/153	127	41	58	A++	A	7.2	162/160	120	7.1	219/215	127	41	58		
	ERST30D-***D	A++	A	7.1	132/132	120	7.1	158	127	41	58	A++	A	7.2	166/165	120	7.1	226/225	127	41	58		
	EHSD-***D	A++	-	7.1	129/128	-	7.1	155/153	-	41	58	A++	-	7.2	162/160	-	7.1	219/215	-	41	58		
	ERSD-***D	A++	-	7.1	13																		



All A++ or Above!!

Outdoor unit	Indoor unit	For medium-temperature application										For low-temperature application									
		Seasonal space heating energy efficiency class		Water heating energy efficiency class		Rated heat output under average climate conditions		Seasonal space heating energy efficiency under average climate conditions		Water heating energy efficiency under average climate conditions		Rated heat output under warmer climate condition		Seasonal space heating energy efficiency under warmer climate condition		Warmer heating energy efficiency under warmer climate conditions		Sound power level LWA indoor		Sound power level LWA outdoor	
		A	B	A	B	kW	%	kW	%	kW	%	kW	%	kW	%	kW	%	kW	%	kW	%
PUHZ-SHW140YHA	EHST20C-***D	A++	A+	15.8	127	138	14.0	153	160	40	70	A++	A+	17.0	163	138	15.5	209	160	40	70
	ERST20C-***D	A++	A+	15.8	128	138	14.0	154	160	40	70	A++	A+	17.0	165	138	15.5	211	160	40	70
	EHST30C-***D	A++	A	15.8	127	118	14.0	153	126	40	70	A++	A	17.0	163	118	15.5	209	126	40	70
	ERST30C-***D	A++	A	15.8	128	118	14.0	154	126	40	70	A++	A	17.0	165	118	15.5	211	126	40	70
	EHSC-***D	A++	-	15.8	127	-	14.0	153	-	40	70	A++	-	17.0	163	-	15.5	209	-	40	70
	ERSC-***D	A++	-	15.8	128	-	14.0	154	-	40	70	A++	-	17.0	165	-	15.5	211	-	40	70
PUHZ-SHW230YKA2	EHSE-***D	A++	-	23.0	127	-	22.8	149	-	45	75	A++	-	25.0	164	-	23.0	199	-	45	75
	ERSE-***D	A++	-	23.0	128	-	22.8	150	-	45	75	A++	-	25.0	165	-	23.0	202	-	45	75
PUZ-WM50VHA(-BS)	EHPT17X-***D(W)	A++	A+	5.0	129	120	5.0	157	135	40	61	A+++	A+	5.0	183	120	5.0	226	135	40	61
	ERPT17X-***D(W)	A++	A+	5.0	133	120	5.0	162	135	40	61	A+++	A+	5.0	190	120	5.0	237	135	40	61
	EHPT20X-***D(W)	A++	A+	5.0	129	135	5.0	157	154	40	61	A+++	A+	5.0	183	135	5.0	226	154	40	61
	ERPT20X-***D(W)	A++	A+	5.0	133	135	5.0	162	154	40	61	A+++	A+	5.0	190	135	5.0	237	154	40	61
	EHPX-***D	A++	-	5.0	129	-	5.0	157	-	40	61	A+++	-	5.0	183	-	5.0	226	-	40	61
	ERPX-***D	A++	-	5.0	133	-	5.0	162	-	40	61	A+++	-	5.0	190	-	5.0	237	-	40	61
PUZ-WM85V/YAA(-BS)	EHPT17X-***D(W)	A++	A+	8.5	139/138	120	8.5	156/155	135	40	58	A+++	A+	8.5	193/190	120	8.5	227/224	135	40	58
	ERPT17X-***D(W)	A++	A+	8.5	141/141	120	8.5	159	135	40	58	A+++	A+	8.5	197/197	120	8.5	234	135	40	58
	EHPT20X-***D(W)	A++	A+	8.5	139/138	145	8.5	156/155	161	40	58	A+++	A+	8.5	193/190	145	8.5	227/224	161	40	58
	ERPT20X-***D(W)	A++	A+	8.5	141/141	145	8.5	159	161	40	58	A+++	A+	8.5	197/197	145	8.5	234	161	40	58
	EHPT30X-***D(W)	A++	A	8.5	139/138	120	8.5	156/155	135	40	58	A+++	A	8.5	193/190	120	8.5	227/224	135	40	58
	ERPT30X-***D(W)	A++	A	8.5	141/141	120	8.5	159	135	40	58	A+++	A	8.5	197/197	120	8.5	234	135	40	58
	EHPX-***D	A++	-	8.5	139/138	-	8.5	156/155	-	40	58	A+++	-	8.5	193/190	-	8.5	227/224	-	40	58
	ERPX-***D	A++	-	8.5	141/141	-	8.5	159	-	40	58	A+++	-	8.5	197/197	-	8.5	234	-	40	58
PUZ-WM112V/YAA(-BS)	EHPT20X-***D(W)	A++	A+	10.0	134/133	148	10.0	152/150	161	40	60	A+++	A+	10.0	191/189	148	10.0	215/213	161	40	60
	ERPT20X-***D(W)	A++	A+	10.0	136/136	148	10.0	154	161	40	60	A+++	A+	10.0	195/195	148	10.0	220	161	40	60
	EHPT30X-***D(W)	A++	A	10.0	134/133	120	10.0	152/150	135	40	60	A+++	A	10.0	191/189	120	10.0	215/213	135	40	60
	ERPT30X-***D(W)	A++	A	10.0	136/136	120	10.0	154	135	40	60	A+++	A	10.0	195/195	120	10.0	220	135	40	60
	EHPX-***D	A++	-	10.0	134/133	-	10.0	152/150	-	40	60	A+++	-	10.0	191/189	-	10.0	215/213	-	40	60
	ERPX-***D	A++	-	10.0	136/136	-	10.0	154	-	40	60	A+++	-	10.0	195/195	-	10.0	220	-	40	60
PUZ-HWM140V/YHA(-BS)	EHPT20X-***D(W)	A++	A+	14.0	132/131	130	14.0	160/159	152	40	67	A+++	A+	14.0	176/175	130	14.0	227/225	152	40	67
	ERPT20X-***D(W)	A++	A+	14.0	133/133	130	14.0	162	152	40	67	A+++	A+	14.0	178/177	130	14.0	232/231	152	40	67
	EHPT30X-***D(W)	A++	A	14.0	132/131	118	14.0	160/159	125	40	67	A+++	A	14.0	176/175	118	14.0	227/225	125	40	67
	ERPT30X-***D(W)	A++	A	14.0	133/133	118	14.0	162	125	40	67	A+++	A	14.0	178/177	118	14.0	232/231	125	40	67
	EHPX-***D	A++	-	14.0	132/131	-	14.0	160/159	-	40	67	A+++	-	14.0	176/175	-	14.0	227/225	-	40	67
	ERPX-***D	A++	-	14.0	133/133	-	14.0	162	-	40	67	A+++	-	14.0	178/177	-	14.0	232/231	-	40	67
PUHZ-FRP71VHA2	EHST20C-***D	A+	A+	7.5	121	138	7.5	150	156	40	68	A++	A+	7.5	163	138	7.5	226	156	40	68
	EHSC-***D	A+	-	7.5	121	-	7.5	150	-	40	68	A++	-	7.5	163	-	7.5	226	-	40	68
PUMY-P112VKM5/YKM(E)4(-BS)	EHST20C-***D	A+	A	11.2	121/121	106	10.0	139	119	40	69	A++	A	11.2	168/168	106	11.2	207	119	40	69
	EHSC-***D	A+	-	11.2	121/121	-	10.0	139	-	40	69	A++	-	11.2	168/168	-	11.2	207	-	40	69
PUMY-P125VKM5/YKM(E)4(-BS)	EHST20C-***D	A+	A	11.2	121/121	106	10.0	139	119	40	69	A++	A	11.2	168/168	106	11.2	207	119	40	69
	EHSC-***D	A+	-	11.2	121/121	-	10.0	139	-	40	69	A++	-	11.2	168/168	-	11.2	207	-	40	69
PUMY-P140VKM5/YKM(E)4(-BS)	EHST20C-***D	A+	A	11.2	121/121	106	10.0	139	119	40	69	A++	A	11.2	168/168	106	11.2	207	119	40	69
	EHSC-***D	A+	-	11.2	121/121	-	10.0	139	-	40	69	A++	-	11.2	168/168	-	11.2	207	-	40	69

